



GTN 725/750

Pilot's Guide

Map



Traffic



Terrain



Weather



Charts



Flight Plan



Procedures



Nearest



Waypoint Info



Services



Utilities



System



© 2011-2019
Garmin International, Inc. or its subsidiaries
All Rights Reserved

Except as expressly provided herein, no part of this manual may be reproduced, copied, transmitted, disseminated, downloaded or stored in any storage medium, for any purpose without the express written permission of Garmin. Garmin hereby grants permission to download a single copy of this manual and of any revision to this manual onto a hard drive or other electronic storage medium to be viewed for personal use, provided that such electronic or printed copy of this manual or revision must contain the complete text of this copyright notice and provided further that any unauthorized commercial distribution of this manual or any revision hereto is strictly prohibited.

This manual reflects the operation of system software v6.60 or later. Some differences in operation may be observed when comparing the information in this manual to later software versions.

This part shall comply with Garmin Banned and Restricted Substances document, 001-00211-00.

Garmin®, FliteCharts®, and SafeTaxi® are registered trademarks of Garmin International or its subsidiaries. Garmin SVT™, Telligence™, and Smart Airspace™ are trademarks of Garmin International or its subsidiaries. These trademarks may not be used without the express permission of Garmin.

NavData® is a registered trademark of Jeppesen, Inc.

SkyWatch® and StormScope® are registered trademarks of L-3 Communications.

© 2018 SiriusXM® Satellite Radio, Sirius, SXM and all related marks and logos are trademarks of SiriusXM Radio Inc. All other marks and logos are property of their respective owners. All rights reserved.

The *Bluetooth*® word mark and logos are registered trademarks owned by Bluetooth SIG, Inc. and any use of such marks by Garmin is under license. Other trademarks and trade names are those of their respective owners.

© 2018 SD® and SDHC Logos are trademarks of SD-3C, LLC. All rights reserved.

Iridium® is a registered trademark of Iridium Communications, Inc. All rights reserved.

The term Wi-Fi® is a registered trademark of the Wi-Fi Alliance®.

United States radar data provided by NOAA; European radar data collected and provided by Meteo France.

For information regarding the Aviation Limited Warranty, refer to Garmin's website.

For aviation product support, visit flyGarmin.com.

Software License Agreement

BY USING THE DEVICE, COMPONENT OR SYSTEM MANUFACTURED OR SOLD BY GARMIN ("THE GARMIN PRODUCT"), YOU AGREE TO BE BOUND BY THE TERMS AND CONDITIONS OF THE FOLLOWING SOFTWARE LICENSE AGREEMENT. PLEASE READ THIS AGREEMENT CAREFULLY. Garmin Ltd. and its subsidiaries ("Garmin") grants you a limited license to use the software embedded in the Garmin Product (the "Software") in binary executable form in the normal operation of the Garmin Product. Title, ownership rights, and intellectual property rights in and to the Software remain with Garmin and/or its third-party providers. You acknowledge that the Software is the property of Garmin and/or its third-party providers and is protected under the United States of America copyright laws and international copyright treaties. You further acknowledge that the structure, organization, and code of the Software are valuable trade secrets of Garmin and/or its third-party providers and that the Software in source code form remains a valuable trade secret of Garmin and/or its third-party providers. You agree not to reproduce, decompile, disassemble, modify, reverse assemble, reverse engineer, or reduce to human readable form the Software or any part thereof or create any derivative works based on the Software. You agree not to export or re-export the Software to any country in violation of the export control laws of the United States of America.

[Foreword](#)[Getting Started](#)[Audio & Xpdr Ctrl](#)[Com/Nav](#)[FPL](#)[Direct-To](#)[Proc](#)[Charts](#)[Wpt Info](#)[Map](#)[Traffic](#)[Terrain](#)[Weather](#)[Nearest](#)[Services/
Music](#)[Utilities](#)[System](#)[Messages](#)[Symbols](#)[Appendix](#)



WARNING: *Navigation and terrain separation must NOT be predicated upon the use of the terrain function. The GTN 7XX Terrain Proximity feature is NOT intended to be used as a primary reference for terrain avoidance and does not relieve the pilot from the responsibility of being aware of surroundings during flight. Terrain Proximity is only to be used as an aid for terrain avoidance and is not certified for use in applications requiring a certified terrain awareness system. Terrain data is obtained from third party sources. Garmin is not able to independently verify the accuracy of the terrain data.*



WARNING: *The displayed minimum safe altitudes (MSAs) are only advisory in nature and should not be relied upon as the sole source of obstacle and terrain avoidance information. Always refer to current aeronautical charts for appropriate minimum clearance altitudes.*



WARNING: *The GTN 7XX has a very high degree of functional integrity. However, the pilot must recognize that providing monitoring and/or self-test capability for all conceivable system failures is not practical. Although unlikely, it may be possible for erroneous operation to occur without a fault indication shown by the GTN 7XX. It is thus the responsibility of the pilot to detect such an occurrence by means of cross-checking with all redundant or correlated information available in the cockpit.*



WARNING: *The altitude calculated by GPS receivers is geometric height above Mean Sea Level and could vary significantly from the altitude displayed by pressure altimeters, such as the output from the GDC 74A/B Air Data Computer, or other altimeters in aircraft. GPS altitude should never be used for vertical navigation. Always use pressure altitude displayed by pressure altimeters in the aircraft.*



WARNING: *Do not use outdated database information. Databases used in the GTN 7XX system must be updated regularly in order to ensure that the information remains current. Pilots using an outdated database do so entirely at their own risk.*



WARNING: *Do not use basemap (land and water data) information for primary navigation. Basemap data is intended only to supplement other approved navigation data sources and should be considered as an aid to enhance situational awareness.*



WARNING: Traffic information shown on the GTN 7XX is provided as an aid in visually acquiring traffic. Pilots must maneuver the aircraft based only upon ATC guidance or positive visual acquisition of conflicting traffic.



WARNING: Do not use data link weather information for maneuvering in, near, or around areas of hazardous weather. Information contained within data link weather products may not accurately depict current weather conditions.



WARNING: Do not use the indicated data link weather product age to determine the age of the weather information shown by the data link weather product. Due to time delays inherent in gathering and processing weather data for data link transmission, the weather information shown by the data link weather product may be significantly older than the indicated weather product age.



WARNING: Never use datalinked weather to attempt to penetrate a thunderstorm. Both the FAA Advisory Circular, Subject: Thunderstorms, and the Airman's Information Manual (AIM) recommend avoiding "by at least 20 miles any thunderstorm identified as severe or giving an intense radar echo."



WARNING: For safety reasons, GTN 7XX operational procedures must be learned on the ground.



WARNING: To reduce the risk of unsafe operation, carefully review and understand all aspects of the GTN 725/750 Pilot's Guide. Thoroughly practice basic operation prior to actual use. During flight operations, carefully compare indications from the GTN 7XX to all available navigation sources, including the information from other NAVAIDs, visual sightings, charts, etc. For safety purposes, always resolve any discrepancies before continuing navigation.



CAUTION: The United States government operates the Global Positioning System and is solely responsible for its accuracy and maintenance. The GPS system is subject to changes which could affect the accuracy and performance of all GPS equipment. Portions of the GTN 7XX utilize GPS as a precision electronic NAVigation AID (NAVAID). Therefore, as with all NAVAIDs, information presented by the GTN 7XX can be misused or misinterpreted and, therefore, become unsafe.

Foreword



CAUTION: The GTN 7XX does not contain any user-serviceable parts. Repairs should only be made by an authorized Garmin service center. Unauthorized repairs or modifications could void both the warranty and the pilot's authority to operate this device under FAA/FCC regulations.

Getting Started

Audio & Xpdr Ctr



CAUTION: The display lens has a special anti-reflective coating that is very sensitive to skin oils, waxes, and abrasive cleaners. **CLEANERS CONTAINING AMMONIA WILL HARM THE ANTI-REFLECTIVE COATING.** It is very important to clean the lens using a clean, lint-free cloth and an eyeglass lens cleaner that is specified as safe for anti-reflective coatings.

Com/Nav

FPL



CAUTION: TFRs provided by datalink weather sources (i.e., FIS-B and SiriusXM) are only advisory and do not replace a thorough preflight briefing on TFR times and locations. Not all TFRs may be shown. To determine accurate TFR information, verify with official sources, i.e., preflight planning or flight service center.

Direct-To

Proc

Charts



NOTE: All visual depictions contained within this document, including screen images of the GTN bezel and displays, are subject to change and may not reflect the most current GTN software. Depictions of equipment may differ slightly from the actual equipment.

Wpt Info

Map

Traffic



NOTE: This device complies with part 15 of the FCC Rules. Operation is subject to the following two conditions: (1) this device may not cause harmful interference, and (2) this device must accept any interference received, including interference that may cause undesired operation.

Terrain

Weather



NOTE: This product, its packaging, and its components contain chemicals known to the State of California to cause cancer, birth defects, or reproductive harm. This notice is being provided in accordance with California's Proposition 65. If you have any questions or would like additional information, please refer to our website at www.garmin.com/propp65.

Nearest

Services/
Music



NOTE: Canadian installations: In accordance with Canadian Radio Specifications Standard 102 (RSS 102), RF field strength exposure to persons from an antenna connected to this device should be limited to 60 V/m for controlled environment and 28 V/m for uncontrolled environment.

Utilities

System

Messages

Symbols

Appendix



NOTE: Do not use SafeTaxi or Chartview functions as the basis for ground maneuvering. SafeTaxi and Chartview functions have not been qualified to be used as an airport moving map display (AMMD). SafeTaxi and Chartview should only be used by the flight crew to orient themselves on the airport surface.



NOTE: The FAA has asked Garmin to remind pilots who fly with Garmin database-dependent avionics of the following:

- It is the pilot's responsibility to remain familiar with all FAA regulatory and advisory guidance and information related to the use of databases in the National Airspace System.
- Garmin equipment will only recognize and use databases that are obtained from Garmin or Jeppesen. Databases obtained from Garmin or Jeppesen are assured compliance with all data quality requirements (DQRs) by virtue of a Type 2 Letter of Authorization (LOA) from the FAA. A copy of the Type 2 LOA is available for each database at flyGarmin.com.
- Use of a current Garmin or Jeppesen database in your Garmin equipment is required for compliance with established FAA regulatory guidance, but does not constitute authorization to fly any and all terminal procedures that may be presented by the system. It is the pilot's responsibility to operate in accordance with established AFM(S) and regulatory guidance or limitations as applicable to the pilot, the aircraft, and installed equipment.



NOTE: The pilot/operator must review and be familiar with Garmin's database exclusion list as discussed in SAIB CE-14-04 to determine what data may be incomplete. To see if an exclusions report exists for a specific database, visit flyGarmin.com.



NOTE: The pilot/operator must have access to Garmin and Jeppesen database alerts and consider their impact on the intended aircraft operation. For a current list of aviation database alerts, visit flyGarmin.com.



NOTE: If the pilot/operator wants or needs to adjust the database, visit flyGarmin.com.



NOTE: *Garmin requests the flight crew report any observed discrepancies related to database information. These discrepancies could come in the form of an incorrect procedure; incorrectly identified terrain, obstacles and fixes; or any other displayed item used for navigation or communication in the air or on the ground. To report an aviation database error, visit flyGarmin.com.*



NOTE: *The GTN touchscreen may not respond to touch commands if condensation or moisture accumulate on the touchscreen.*



NOTE: *Depending on software version and configuration, GTN features and screen images may differ from those shown in this manual.*

NOTE: This device complies with Part 15 of the FCC limits for Class B digital devices. This equipment generates, uses, and can radiate radio frequency energy and, if not installed and used in accordance with the instructions, may cause harmful interference to radio communications. Furthermore, there is no guarantee that interference will not occur in a particular installation.

If this equipment does cause harmful interference, the user is encouraged to try to correct the interference by relocating the equipment or connecting the equipment to a different circuit than the affected equipment. Consult an authorized dealer or other qualified avionics technician for additional help if these remedies do not correct the problem.

Operation of this device is subject to the following conditions: (1) This device may not cause harmful interference, and (2) this device must accept any interference received, including interference that may cause undesired operation.

To obtain accessories for your unit, please contact your Garmin dealer.

The display surface is coated with a special anti-reflective coating which is very sensitive to skin oils, waxes and abrasive cleaners. It is very important to clean the lens using an eyeglass lens cleaner which is specified as safe for anti-reflective coatings and a clean, lint-free cloth.

AC 90-100A Statement of Compliance.
The Garmin navigational unit meets the performance and functional requirements of FAA Advisory Circular (AC) 90-100A, *U.S. Terminal and En Route Area Navigation (RNAV) Operations*.

Product Registration and Support

Help us better support you by completing your online registration today! Have the serial number of your product handy and visit flyGarmin.com.

- Foreword
- Getting Started
- Audio & Xpdr Ctrl
- Com/Nav
- FPL
- Direct-To
- Proc
- Charts
- Wpt Info
- Map
- Traffic
- Terrain
- Weather
- Nearest
- Services/Music
- Utilities
- System
- Messages
- Symbols
- Appendix

Record of Revisions			
Part Number	Revision	Date	Description
190-01007-03	1	01/24/11	Initial Release.
	A	02/04/11	Production Release.
	B	03/16/11	Update information.
	C	11/29/12	Updates for software v3.0.
	D	02/28/13	Updates for software v4.0.
	E	03/25/13	Updates for software v4.10.
	F	08/26/13	Updates for software v5.0.
	G	08/01/14	Updates for software v5.11.
	H	10/17/14	Updates for software v5.12.
	J	07/2015	Updates for software v6.00.
	K	01/2016	Updates for software v6.10.
	L	02/2016	Minor edits.
	M	03/2016	No content change. Updated file for printer.
	N	09/2016	Updates for software v6.20.
	P	08/2017	Updates for software v6.30.
	Q	08/2018	Updates for software v6.50.
R	04/2019	Updates for software v6.60.	

Foreword

Getting Started

Audio & Xpdr Ctrl

Com/Nav

FPL

Direct-To

Proc

Charts

Wpt Info

Map

This page intentionally left blank

Traffic

Terrain

Weather

Nearest

Services/
Music

Utilities

System

Messages

Symbols

Appendix

Table of Contents

Software License Agreement	i	
Product Registration and Support	vii	Audio & Xpdr Ctrl
Welcome	xxvii	Com/Nav
About This Guide	xxvii	FPL
Electronic Document Features	xxvii	
Conventions	xxviii	
1 Getting Started	1-1	
1.1 Model Descriptions	1-1	Direct-To
1.2 About This Pilot's Guide	1-2	
1.3 Product Description	1-3	Proc
1.4 Unit Power Up	1-6	
1.5 System Operation	1-11	Charts
1.6 Direct-To Navigation	1-16	Wpt Info
1.7 Selecting Com/Nav Frequencies	1-17	
1.8 Flight Planning	1-19	Map
1.9 VFR and IFR Procedures	1-20	
1.10 Dead Reckoning	1-21	Traffic
1.11 FastFind Predictive Waypoint Entry	1-22	
2 Audio and Transponder Controls (Optional)	2-1	Terrain
2.1 Transponder Operation	2-1	Weather
2.1 Audio Panel Operation	2-9	
2.2 Intercom Setup	2-18	Nearest
2.3 Telligence™ Voice Command	2-26	Services/Music
3 NAV/COM (GTN 750 NAV/COM)	3-1	
3.1 Volume	3-2	Utilities
3.2 Squelch	3-2	
3.3 Com Window and Tuning	3-3	System
3.4 Com Frequency Monitoring	3-15	
3.5 NAV (VOR/Localizer/Glideslope) Receiver Operations	3-16	Messages
4 Flight Plans	4-1	Symbols
4.1 Creating a New Flight Plan	4-2	
4.1.1 Creating a New Flight Plan in the Catalog	4-2	Appendix

Foreword			
Getting Started	4.1.2	Creating a New Flight Plan from the Active Flight Plan	4-3
Audio & Xpdr Ctrl	4.2	Active Flight Plan Page.....	4-4
Com/Nav	4.2.1	Waypoint Options.....	4-5
FPL	4.2.1.1	Activate Leg	4-6
Direct-To	4.2.1.2	Insert Before	4-7
Proc	4.2.1.3	Insert After	4-9
Charts	4.2.1.4	Along Track Offsets.....	4-9
Wpt Info	4.2.1.5	Remove.....	4-12
Map	4.2.1.6	Load Procedures.....	4-13
Traffic	4.2.1.7	Waypoint Info.....	4-14
Terrain	4.2.2	Airways.....	4-15
Weather	4.2.3	Load Hold at Waypoint	4-19
Nearest	4.2.3.1	Hold at Waypoint.....	4-19
Services/Music	4.2.3.2	Removing a Hold.....	4-20
Utilities	4.2.4	Load Search and Rescue Patterns (Optional).....	4-21
System	4.2.4.1	Creating a Parallel Track Pattern.....	4-23
Messages	4.2.4.2	Creating a Sector Search Pattern.....	4-25
Symbols	4.2.4.3	Creating an Expanding Square Pattern	4-26
Appendix	4.2.4.4	Creating an Orbit Pattern.....	4-27
	4.3	Flight Plan Menu	4-28
	4.3.1	Store Flight Plan	4-29
	4.3.2	Invert Flight Plan	4-30
	4.3.3	En Route Vertical Navigation.....	4-30
	4.3.3.1	VNAV Requirements	4-30
	4.3.3.2	VNAV Limitations	4-31
	4.3.3.3	VNAV Profile Page.....	4-31
	4.3.3.4	Altitude Constraints.....	4-32
	4.3.3.5	VNAV Direct-To	4-36
	4.3.3.6	Transition to Approach.....	4-36
	4.3.4	Temperature Compensated Altitude	4-37
	4.3.4.1	Temperature Compensation Requirements	4-37
	4.3.4.2	Setting Temperature Compensated Altitude	4-37
	4.3.5	Parallel Track	4-38
	4.3.6	Edit Data Fields	4-41
	4.3.7	Flight Plan Catalog Route Options	4-43
	4.3.7.1	Catalog Route Option - Activate.....	4-44
	4.3.7.2	Catalog Route Option - Invert & Activate.....	4-44
	4.3.7.3	Catalog Route Option - Preview.....	4-45

4.3.7.4	Catalog Route Option - Edit.....	4-45
4.3.7.5	Catalog Route Option - Copy.....	4-46
4.3.7.6	Catalog Route Option - Delete.....	4-47
4.3.8	Delete Flight Plan.....	4-47
4.3.8.1	Delete Flight Plan from Catalog.....	4-47
4.3.8.2	Delete All Flight Plans from Catalog.....	4-49
4.3.8.3	Delete Active Flight Plan.....	4-50
4.3.9	Preview Flight Plan.....	4-51
4.3.9.1	Previewing the Active Flight Plan.....	4-51
4.3.9.2	Previewing a Flight Plan in the Catalog.....	4-51
4.4	Graphically Editing a Flight Plan.....	4-52
4.5	Import Flight Plans with Connex.....	4-52
4.5.1	Operation.....	4-52
4.5.2	Potential Errors.....	4-54
4.6	Import Flight Plans with a Datacard.....	4-56
4.6.1	Potential Errors.....	4-58
5	Direct-To.....	5-1
5.1	Direct-To Navigation.....	5-1
5.2	Direct-To a Flight Plan Waypoint.....	5-3
5.3	Direct-To a Nearest Airport.....	5-5
5.4	Removing a Direct-To Course.....	5-7
5.5	Direct-To Map Waypoint.....	5-8
5.6	Off-Route Direct-To Course.....	5-9
5.7	Graphically Editing a Direct-To Route.....	5-9
5.8	Direct-To a User-Defined Hold.....	5-9
5.9	Direct-To a Search and Rescue Pattern.....	5-12
6	Procedures.....	6-1
6.1	Basic Approach Operations.....	6-2
6.2	Selecting a Departure.....	6-4
6.3	Selecting an Arrival.....	6-7
6.4	Selecting an Approach.....	6-10
6.5	Approaches with Procedure Turns.....	6-14
6.6	Flying the Missed Approach.....	6-14
6.7	Flying an Approach with a Hold.....	6-15
6.8	Flying a DME Arc Approach.....	6-16
6.9	Radius-to-Fix (RF) Approaches.....	6-16
6.10	Vectors to Final.....	6-17

Foreword
Getting Started
Audio & Xpdr Ctrl
Com/Nav
FPL
Direct-To
Proc
Charts
Wpt Info
Map
Traffic
Terrain
Weather
Nearest
Services/ Music
Utilities
System
Messages
Symbols
Appendix

	6.11 ILS Approaches (GTN 750 Only)	6-18
Foreword	6.12 RNAV Approach Procedures	6-19
Getting Started	6.12.1 Flying the LPV Approach	6-20
	6.12.2 Flying the LP Approach	6-21
Audio & Xpdr Ctrl	6.13 Visual Approach Procedures	6-23
	6.14 Points to Remember for All Procedures	6-26
Com/Nav	6.15 Points to Remember for Localizer or VOR-based Approaches.....	6-27
FPL	6.16 Enabling Autopilot Outputs for the King KAP140/KFC225.....	6-29
Direct-To	7 Charts.....	7-1
	7.1 Chart Page	7-3
Proc	7.1.1 Airport Selection.....	7-4
	7.1.2 Info.....	7-5
Charts	7.1.3 Information	7-5
	7.1.4 Approaches.....	7-6
Wpt Info	7.1.5 Departures	7-7
	7.1.6 Arrivals	7-8
Map	7.1.7 Airport Info	7-9
	7.1.8 Full/Split Screen.....	7-10
Traffic	7.2 Chart Menu Options	7-11
	7.2.1 Chart Layers - All	7-12
Terrain	7.2.2 Chart Layers - Header	7-12
	7.2.3 Chart Layers - Plan	7-12
Weather	7.2.4 Chart Layers - Profile	7-13
	7.2.5 Chart Layers - Minimums	7-13
Nearest	7.2.6 Invert Colors.....	7-14
Services/ Music	7.2.7 Geo-Referenced Aircraft Position.....	7-14
	7.3 ChartView Cycle Number and Revision	7-15
Utilities	7.4 FliteCharts®	7-16
	7.5 SafeTaxi®	7-17
System	7.5.1 Using SafeTaxi®	7-18
	7.5.2 Hot Spot Information.....	7-18
Messages	7.5.3 SafeTaxi® Cycle Number and Revision	7-19
Symbols	8 Waypoint Info	8-1
	8.1 Waypoint Selection	8-3
Appendix	8.2 Airport.....	8-4

8.2.1	Info.....	8-4
8.2.2	Preview.....	8-5
8.2.3	Procedures.....	8-6
8.2.4	Runways.....	8-7
8.2.5	Frequencies.....	8-8
8.2.6	Weather (WX) Data.....	8-9
8.2.7	NOTAM Pages.....	8-10
8.2.8	Helipads.....	8-10
8.2.9	Nearest VRPs.....	8-11
8.3	Intersection (INT).....	8-12
8.4	VOR.....	8-13
8.5	VRP.....	8-14
8.6	NDB.....	8-15
8.7	User Waypoints.....	8-16
8.7.1	Select User Waypoint from a List.....	8-17
8.7.2	Edit User Waypoint.....	8-17
8.7.3	Delete User Waypoint.....	8-17
8.7.4	Delete All User Waypoints.....	8-18
8.8	Create Waypoint.....	8-19
8.8.1	Mark On Target.....	8-20
8.8.2	Waypoint Location Based on LAT/LON.....	8-21
8.8.3	Waypoint Location Based on Two Radials.....	8-22
8.8.4	Waypoint Location Based on Radial and Distance.....	8-23
8.9	Import User Waypoints (Datacard).....	8-24
9	Map.....	9-1
9.1	Map Menu.....	9-3
9.1.1	Map Overlays.....	9-4
9.1.1.1	Overlay Priority.....	9-4
9.1.1.2	Topo.....	9-5
9.1.1.3	Airways.....	9-6
9.1.1.4	Terrain.....	9-7
9.1.1.5	NEXRAD (Optional).....	9-8
9.1.1.6	Charts (Optional).....	9-9
9.1.1.7	StormScope® (Optional).....	9-11
9.1.1.8	Radar (Optional).....	9-12
9.1.1.9	Traffic (Optional).....	9-12
9.1.2	Map Setup.....	9-13

Foreword	9.1.2.1	Map.....	9-15
	9.1.2.2	Aviation	9-27
Getting Started	9.1.2.3	Land	9-28
	9.1.2.4	Airspace.....	9-29
Audio & Xpdr Ctrl	9.1.2.5	Airway Range.....	9-32
	9.1.2.6	Traffic (Optional).....	9-33
Com/Nav	9.1.2.7	Weather (Optional).....	9-34
	9.1.3	Change User Fields.....	9-35
FPL	9.1.4	Map Detail	9-39
	9.2	Map Panning	9-41
Direct-To	9.3	Map Controls.....	9-44
	9.3.1	Pan Map Mode.....	9-44
Proc	9.3.2	Create Waypoint.....	9-44
	9.3.3	Graphically Edit Flight Plan Mode	9-45
Charts	9.3.3.1	Adding a Waypoint Within an Existing Flight Plan.....	9-45
	9.3.3.2	Adding a Waypoint to the End of an Existing Flight Plan.....	9-47
Wpt Info	9.3.3.3	Removing a Waypoint from an Existing Flight Plan	9-47
	9.3.3.4	Creating a Flight Plan Without an Existing Flight Plan.....	9-48
Map	9.4	CDI (GTN 750 only)	9-50
	9.5	OBS.....	9-51
Traffic	9.6	Map Symbols.....	9-52
	9.7	Flight Plan Depiction.....	9-53
Terrain	10	Traffic.....	10-1
Weather	10.1	Traffic Pop-Up.....	10-1
	10.2	Traffic Test	10-2
Nearest	10.3	TIS (Optional)	10-3
	10.3.1	TIS Symbology.....	10-4
Services/ Music	10.3.2	Traffic Page	10-5
	10.3.3	Displaying Traffic on the Traffic Page.....	10-6
Utilities	10.3.4	Altitude Display.....	10-6
	10.3.5	TIS Limitations.....	10-7
System	10.3.6	TIS Alerts.....	10-9
	10.3.7	TIS System Status	10-10
Messages	10.4	TAS (Optional)	10-12
	10.4.1	TAS Symbology.....	10-13
Symbols	10.4.2	Displaying and Operating Traffic (TAS Systems).....	10-14
Appendix	10.4.2.1	Switching from Standby Mode to Operating Mode	10-14

10.4.2.2	Range Ring	10-15
10.4.3	Altitude Display	10-15
10.4.4	Traffic System Status	10-16
10.5	ADS-B Traffic	10-17
10.5.1	Traffic Applications - SURF, AIRB, etc.	10-19
10.5.2	ADS-B Traffic Menu	10-19
10.5.2.1	ADS-B Display	10-19
10.5.2.2	TCAS Status	10-20
10.5.2.3	Test	10-20
10.5.2.4	Motion Vector	10-20
10.5.2.5	Vector Duration	10-23
10.5.2.6	Altitude Filter	10-23
10.5.2.7	On Scene Mode	10-24
10.5.3	Rotorcraft Traffic Page Orientation	10-24
10.6	RYAN TCAD 9900BX with the GDL 88	10-25
10.6.1	Ryan TCAD Description	10-25
10.6.2	Altitude Mode	10-26
10.6.3	TCAD Control Menu	10-27
10.6.3.1	Traffic Audio	10-28
10.6.3.2	Field Elevation	10-28
10.6.3.3	Baro	10-29
10.6.3.4	Operate	10-29
10.6.3.5	Ground Mode	10-29
10.6.3.6	Approach Mode	10-29
10.7	TCAD 9900B Operation	10-30
10.7.1	Select Local Barometric Pressure	10-30
10.7.2	Select Active Shield	10-31
10.7.3	TCAD 9900B Traffic Menu	10-31
10.7.3.1	Traffic Audio	10-31
10.7.3.2	Shield Setup	10-32
10.7.3.3	Approach Mode	10-33
10.8	TCAD 9900BX Operation	10-34
10.8.1	Select Local Barometric Pressure	10-34
10.8.2	Select Altitude Filter	10-35
10.8.3	TCAD 9900BX Traffic Menu	10-35
10.8.3.1	Traffic Audio	10-36
10.8.3.2	Shield Setup	10-36
10.8.3.3	Approach Mode	10-37

Foreword	10.8.3.4	Ground Mode.....	10-37
Getting Started	10.9	TCAS II	10-38
Audio & Xpdr Ctrl	10.9.1	TCAS II Theory of Operation	10-38
Com/Nav	10.9.2	TCAS II with ADS-B.....	10-40
FPL	10.9.3	TCAS II Alerts	10-41
Direct-To	10.9.3.1	Resolution Advisories.....	10-43
Proc	10.9.4	TCAS II System Test	10-45
Charts	10.9.5	TCAS II Operation.....	10-46
Wpt Info	10.9.5.1	Altitude Display.....	10-47
Map	10.9.5.2	Traffic System Status.....	10-47
Traffic	10.9.5.3	External Display.....	10-47
Terrain	11	Terrain.....	11-1
Weather	11.1	Terrain Configurations.....	11-1
Nearest	11.2	GPS Altitude for Terrain	11-2
Services/Music	11.2.1	GSL Altitude & Indicated Altitude	11-2
Utilities	11.3	General Database Information.....	11-3
System	11.3.1	Database Versions	11-3
Messages	11.3.2	HTAWS Database Requirements.....	11-3
Symbols	11.3.3	Database Updates	11-3
Appendix	11.3.4	Terrain Database Areas of Coverage.....	11-4
	11.3.5	Obstacle Database Areas of Coverage.....	11-5
	11.4	Terrain Proximity	11-6
	11.4.1	Displaying Terrain Proximity	11-7
	11.4.1.1	Terrain Page 120° Arc or 360° Rings.....	11-8
	11.4.1.2	Display Flight Plan on Terrain Page.....	11-8
	11.4.1.3	Display Terrain and Obstacle Legend	11-8
	11.4.2	Terrain Limitations	11-9
	11.5	Terrain Alerting	11-10
	11.5.1	Terrain Alerting Requirements	11-10
	11.5.2	Terrain Alerting Limitations	11-10
	11.5.3	Using Terrain Alerting	11-11
	11.5.4	Displaying Terrain Alerting Data	11-11
	11.5.5	Terrain Page	11-13
	11.5.5.1	Terrain Page Layers.....	11-13
	11.5.5.2	Terrain Page View	11-14
	11.5.5.3	Terrain Alerting Selections.....	11-14
	11.5.6	Terrain Alerts	11-15

11.5.6.1	Terrain Alerting Colors and Symbology	11-16
11.5.6.2	Forward Looking Terrain Avoidance	11-17
11.5.6.3	Premature Descent Alerting	11-18
11.5.6.4	Inhibiting/Enabling PDA/FLTA Alerting	11-18
11.5.6.5	Altitude Voice Call Out (VCO)	11-19
11.5.6.6	Terrain Not Available Alert	11-19
11.5.6.7	Terrain Failure Alert	11-19
11.5.7	Terrain System Status.....	11-20
11.6	TAWS-B (Optional).....	11-21
11.6.1	TAWS-B Requirements.....	11-21
11.6.2	TAWS-B Limitations.....	11-21
11.6.3	Using TAWS-B	11-22
11.6.4	Displaying TAWS-B Data	11-22
11.6.5	TAWS-B Page	11-24
11.6.5.1	Terrain Page Layers.....	11-24
11.6.5.2	Terrain Page View	11-25
11.6.5.3	Terrain Page TAWS-B Selections	11-25
11.6.6	TAWS-B Alerts	11-26
11.6.6.1	TAWS-B Alerting Colors and Symbology	11-27
11.6.6.2	Excessive Descent Rate Alert.....	11-29
11.6.6.3	Forward Looking Terrain Avoidance	11-29
11.6.6.4	Premature Descent Alerting	11-30
11.6.6.5	Inhibiting/Enabling TAWS-B PDA/FLTA Alerting	11-31
11.6.6.6	Negative Climb Rate After Take-Off Alert (NCR)	11-31
11.6.6.7	Altitude Voice Call Out (VCO)	11-33
11.6.6.8	TAWS-B Not Available Alert	11-33
11.6.6.9	TAWS-B Failure Alert.....	11-33
11.6.7	TAWS-B System Status.....	11-33
11.7	HTAWS (Optional).....	11-34
11.7.1	HTAWS Requirements.....	11-34
11.7.2	HTAWS Limitations	11-35
11.7.3	Power Up	11-35
11.7.4	HTAWS Page	11-36
11.7.4.1	View Selection.....	11-37
11.7.4.2	HTAWS Inhibit.....	11-38
11.7.4.3	External HTAWS Inhibit Control.....	11-39
11.7.4.4	Reduced Protection Mode.....	11-39
11.7.4.5	HTAWS Manual Test	11-40

Foreword

Getting Started

Audio & Xpdr Ctrl

Com/Nav

FPL

Direct-To

Proc

Charts

Wpt Info

Map

Traffic

Terrain

Weather

Nearest

Services/ Music

Utilities

System

Messages

Symbols

Appendix

Foreword	11.7.4.6	HTAWS Legend.....	11-40
	11.7.4.7	Flight Plan Overlay	11-41
Getting Started	11.7.5	HTAWS Symbols	11-42
	11.7.6	HTAWS Alerts	11-44
Audio & Xpdr Ctrl	11.7.6.1	Forward Looking Terrain Avoidance	11-44
	11.7.6.2	HTAWS Voice Call Out Aural Alert	11-45
Com/Nav	11.7.6.3	HTAWS Voice Call Out Selection.....	11-46
	11.7.6.4	HTAWS Not Available Alert	11-48
FPL	11.7.6.5	HTAWS Failure Alert.....	11-48
	11.7.6.6	HTAWS Alert Summary.....	11-48
Direct-To	11.7.7	Pilot Actions	11-50
	11.8	TAWS-A (Optional).....	11-51
Proc	11.8.1	TAWS-A Requirements.....	11-51
	11.8.2	TAWS-A Limitations.....	11-51
Charts	11.8.3	Displaying TAWS-A Data.....	11-52
	11.8.4	TAWS-A Page	11-53
Wpt Info	11.8.5	TAWS-A Alerts.....	11-56
	11.8.5.1	TAWS-A Alert Types	11-56
Map	11.8.5.2	TAWS-A Alerts Summary.....	11-57
	11.8.5.3	Excessive Descent Rate Alert.....	11-61
Traffic	11.8.5.4	Forward Looking Terrain Avoidance	11-62
	11.8.5.5	Premature Descent Alerting	11-63
Terrain	11.8.5.6	Inhibiting/Enabling TAWS-A PDA/FLTA Alerting.....	11-64
	11.8.5.7	Excessive Closure Rate Alert	11-64
Weather	11.8.5.8	Flight Into Terrain Alert	11-66
	11.8.5.9	Negative Climb Rate After Take-Off Alert (NCR).....	11-68
Nearest	11.8.5.10	Excessive Below Glideslope/Glidepath Deviation Alert	11-69
Services/ Music	11.8.5.11	Inhibiting GPWS Alerts (EDR, ECR, FIT, and NCR).....	11-71
	11.8.6	Altitude Voice Call Out (VCO)	11-71
Utilities	11.8.7	TAWS-A System Status	11-72
	11.8.8	TAWS-A Abnormal Operations	11-72
System	12	Weather	12-1
Messages	12.1	SiriusXM Weather Products (Optional)	12-2
	12.1.1	Displaying SiriusXM Weather	12-3
Symbols	12.1.2	Weather Legend.....	12-5
	12.1.3	Weather Map Orientation.....	12-6
Appendix	12.1.4	SiriusXM Product Age.....	12-7

12.1.5	NEXRAD	12-8	Foreword
12.1.5.1	Reflectivity	12-10	Getting Started
12.1.5.2	NEXRAD Limitations	12-11	Audio & Xpdr Ctrl
12.1.5.3	Animating NEXRAD	12-12	Com/Nav
12.1.6	Echo Tops	12-14	FPL
12.1.7	Cloud Tops	12-15	Direct-To
12.1.8	Cell Movement	12-16	Proc
12.1.9	SIGMETs and AIRMETs	12-17	Charts
12.1.10	County Warnings	12-18	Wpt Info
12.1.11	Freezing Level	12-19	Map
12.1.12	METARs	12-20	Traffic
12.1.13	Cyclone	12-21	Terrain
12.1.14	Lightning	12-22	Weather
12.1.15	City Forecast	12-23	Nearest
12.1.16	Surface Analysis	12-24	Services/Music
12.1.17	Winds Aloft	12-25	Utilities
12.1.18	Icing	12-26	System
12.1.19	Turbulence	12-27	Messages
12.1.20	AIREP/PIREP	12-28	Symbols
12.2	StormScope® Weather	12-29	Appendix
12.2.1	StormScope® (Optional)	12-29	
12.2.2	Clearing the StormScope® Page	12-31	
12.2.3	Changing the StormScope® Display View	12-31	
12.2.4	Changing the StormScope® Data Mode	12-32	
12.2.5	Changing the StormScope® Data Display Range	12-32	
12.2.6	Displaying StormScope® Data on the Map Page	12-32	
12.3	Weather Radar	12-33	
12.3.1	Garmin GWX Radar Description	12-33	
12.3.1.1	Principles of Pulsed Airborne Weather Radar	12-33	
12.3.1.2	Antenna Beam Illumination	12-34	
12.3.1.3	Radar Signal Attenuation	12-35	
12.3.2	Radar Signal Reflectivity	12-36	
12.3.2.1	Precipitation	12-36	
12.3.2.2	Ground Returns	12-37	
12.3.2.3	Angle of Incidence	12-37	
12.3.3	Operating Distance	12-38	
12.3.3.1	Maximum Permissible Exposure Level (MPEL) (GWX 68)	12-38	
12.3.3.2	Maximum Permissible Exposure Level (MPEL)		

	(Other Radars).....	12-38
Foreword	12.3.4 Basic Antenna Tilt Setup	12-39
Getting Started	12.3.5 Weather Mapping and Interpretation	12-41
Audio & Xpdr Ctrl	12.3.5.1 Weather display Interpretation.....	12-41
	12.3.5.2 Thunderstorms	12-41
	12.3.5.3 Tornadoes	12-43
Com/Nav	12.3.5.4 Hail.....	12-44
	12.4 GWX Radar Operation in Weather Mode	12-45
FPL	12.4.1 Viewing Weather on the Weather Radar Page	12-46
	12.4.2 Weather Radar Modes.....	12-47
Direct-To	12.4.3 Vertically Scanning a Storm Cell.....	12-48
	12.4.4 Adjusting the Antenna Tilt Angle.....	12-49
Proc	12.4.5 Adjusting the Bearing Line.....	12-50
	12.4.6 Adjusting Gain	12-51
Charts	12.4.7 Weather Radar Menu	12-52
	12.4.7.1 Weather Attenuated Color Highlight (WATCH™)	12-52
Wpt Info	12.4.7.2 Weather Messages	12-53
	12.4.7.3 Antenna Stabilization	12-54
Map	12.4.7.4 Altitude Compensated Tilt (GWX 70/75/80 Only).....	12-54
	12.4.7.5 Turbulence Detection (GWX 70/75/80 Only).....	12-54
Traffic	12.4.7.6 Ground Clutter Suppression (GWX 70 Only).....	12-54
	12.4.7.7 Sector Scan	12-55
Terrain	12.5 Connex Weather	12-56
Weather	12.5.1 Using Connex Satellite Weather Products.....	12-57
	12.5.2 Connex Weather Menu.....	12-58
Nearest	12.5.3 Connex Settings.....	12-58
	12.5.3.1 Connex Data Request.....	12-59
Services/ Music	12.5.3.2 Connex Data Request Coverage Region	12-60
	12.5.3.3 Connex Weather Map Orientation.....	12-60
Utilities	12.5.4 Register with Connex	12-61
	12.5.5 Connex Weather Product Age	12-63
System	12.5.6 TFRs.....	12-63
	12.5.7 Precipitation (PRECIP) Data	12-64
Messages	12.5.7.1 Animating Precipitation Data.....	12-65
	12.5.8 Lightning.....	12-65
Symbols	12.5.9 Infrared Satellite Data.....	12-66
	12.5.10 METARs	12-66
Appendix	12.5.11 PIREPs	12-68

12.5.12	Winds Aloft	12-69
12.5.13	SIGMETs and AIRMETs	12-70
12.6	FIS-B Weather.....	12-71
12.6.1	FIS-B Operation.....	12-74
12.6.2	FIS-B NEXRAD.....	12-75
12.6.2.1	Radar Data Animations.....	12-76
12.6.2.2	CONUS and Regional NEXRAD	12-77
12.6.2.3	NEXRAD Abnormalities.....	12-78
12.6.3	FIS-B TFRs	12-81
12.6.4	Cloud Tops.....	12-82
12.6.5	Lightning.....	12-83
12.6.6	FIS-B METARs.....	12-84
12.6.7	FIS-B SIGMETs and Textual AIRMETs	12-85
12.6.8	Graphical AIRMETs	12-86
12.6.9	Center Weather Advisory	12-88
12.6.10	FIS-B Winds and Temperatures Aloft.....	12-89
12.6.11	Icing	12-90
12.6.12	Turbulence	12-91
12.6.13	FIS-B PIREPs.....	12-92
13	Nearest	13-1
13.1	Select a Nearest Page	13-2
13.2	Nearest Airport	13-2
13.3	Nearest Intersection (INT)	13-4
13.4	Nearest VOR	13-6
13.5	Nearest VRP	13-8
13.6	Nearest NDB.....	13-10
13.7	Nearest User Waypoint.....	13-11
13.8	Nearest Airspace.....	13-12
13.9	Nearest ARTCC	13-15
13.10	Nearest Flight Service Station (FSS)	13-17
13.11	Nearest Weather Frequency (WX Freq).....	13-19
14	Services/Music	14-1
14.1	Music	14-2
14.2	Activating SiriusXM Satellite Radio Services	14-3
14.3	Music Operation	14-4
14.3.1	Browsing Channels and Categories.....	14-5
14.3.2	Selecting an SiriusXM Satellite Radio Channel by Number ...	14-6

Foreword	14.3.3	SiriusXM Satellite Radio Volume.....	14-7
	14.3.4	SiriusXM Satellite Radio Channel Presets	14-8
	14.3.4.1	Saving a Preset.....	14-8
	14.3.4.2	Recalling a Preset	14-8
	14.3.5	GDL 69/69A Data Link Receiver Troubleshooting.....	14-9
Com/Nav	14.4	Iridium Phone Operation (Optional).....	14-11
	14.4.1	Status	14-11
FPL	14.4.2	Making a Phone Call	14-12
	14.4.3	Answering a Phone Call	14-14
Direct-To	14.4.4	Suppress Visuals.....	14-15
	14.4.5	Phone Volume	14-16
Proc	14.4.6	SMS Text Operation	14-16
	14.4.6.1	SMS Text Messaging Menu	14-17
Charts	14.4.6.2	Composing a SMS Text Message.....	14-17
	14.4.6.3	A Failed SMS Text Message.....	14-18
Wpt Info	14.4.7	Position Reporting	14-19
	14.4.7.1	Status	14-20
Map	14.4.7.2	Position Reporting Status.....	14-20
	14.4.8	Contacts	14-21
Traffic	14.4.8.1	Creating a Contact	14-21
	14.4.8.2	Using a Contact	14-22
Terrain	15	Utilities	15-1
Weather	15.1	Vertical Calculator (VCALC).....	15-4
	15.1.1	Target Altitude.....	15-6
Nearest	15.1.2	Altitude Type	15-6
	15.1.3	Vertical Speed (VS) Profile.....	15-7
Services/ Music	15.1.4	Target Offset	15-8
	15.1.5	Before/After Target Waypoint	15-8
Utilities	15.1.6	Target Waypoint	15-9
	15.1.7	Display VCALC Messages.....	15-10
System	15.1.8	Restore VCALC Defaults.....	15-10
	15.2	Flight Timers	15-11
Messages	15.3	RAIM Prediction.....	15-12
Symbols	15.4	Trip Planning	15-13
	15.4.1	Point-To-Point Mode.....	15-15
Appendix	15.4.2	Flight Plan Mode.....	15-20

15.5	Fuel Planning.....	15-23
15.5.1	Point-To-Point Mode.....	15-24
15.5.2	Flight Plan Mode.....	15-27
15.6	DALT/TAS/Winds.....	15-29
15.7	Clean Screen Mode.....	15-34
15.8	Scheduled Messages.....	15-35
15.9	Checklists.....	15-37
15.9.1	Checklists Menu.....	15-37
15.9.2	Viewing Checklists.....	15-38
16	System.....	16-1
16.1	System Status.....	16-3
16.1.1	Serial Number and System ID.....	16-4
16.1.2	Version Information.....	16-4
16.1.3	Database Information.....	16-4
16.2	GPS Status.....	16-4
16.2.1	GPS Status Page.....	16-4
16.2.2	Satellite-Based Augmentation System (SBAS).....	16-8
16.2.3	Circle of Uncertainty.....	16-9
16.2.4	GPS Faults.....	16-10
16.3	External LRUs.....	16-11
16.3.1	GDL 69 (and GDL 69A) Status.....	16-11
16.3.2	GDL 88 or GTX 345 Status.....	16-13
16.3.3	GSR 56 Status.....	16-14
16.4	Setup.....	16-15
16.4.1	CDI Scale Selection.....	16-16
16.4.2	Date/Time.....	16-18
16.4.3	Nearest Airport Criteria.....	16-19
16.4.4	Com/Nav Setup.....	16-20
16.4.4.1	Com Channel Spacing.....	16-20
16.4.4.2	Reverse Frequency Look-Up.....	16-21
16.4.4.3	COM Sidetone Control.....	16-22
16.4.5	Keyboard Format.....	16-23
16.4.6	Crossfill.....	16-24
16.4.6.1	GTN-to-GTN Crossfilling.....	16-25
16.4.6.2	GTN-GNS Crossfilling.....	16-26
16.4.6.3	GTN-G3X Touch Crossfilling.....	16-27
16.5	Alerts Settings.....	16-28

Foreword

Getting Started

Audio & Xpdr Ctrl

Com/Nav

FPL

Direct-To

Proc

Charts

Wpt Info

Map

Traffic

Terrain

Weather

Nearest

Services/ Music

Utilities

System

Messages

Symbols

Appendix

Foreword	16.6	User Fields.....	16-30
	16.7	Units Settings	16-33
Getting Started	16.7.1	Setup Units	16-33
	16.7.2	Setting a User-Configured (Manual) Nav Angle	16-34
Audio & Xpdr Ctrl	16.7.3	Position Format Selection.....	16-37
	16.8	Audio	16-39
Com/Nav	16.9	Backlight Settings	16-41
	16.10	Connex Setup - GSR 56	16-42
FPL	16.11	Connex Setup - Flight Stream 210 and 510	16-42
	16.11.1	Operation.....	16-43
Direct-To	16.11.2	Pairing a Device.....	16-44
	16.12	Connex Setup – Other Bluetooth Devices	16-45
Proc	16.13	Voice Command	16-46
	17	Messages	17-1
Charts	18	Symbols.....	18-1
Wpt Info	18.1	Map Page Symbols.....	18-1
	18.2	SafeTaxi™ Symbols	18-2
Map	18.3	Traffic Symbols.....	18-2
	18.4	Terrain Obstacle Symbols	18-5
Traffic	18.5	HTAWS Obstacle Symbols.....	18-6
	18.6	Basemap Symbols	18-7
Terrain	18.7	Map Tool Bar Symbols.....	18-8
	18.8	Miscellaneous Symbols	18-9
Weather	18.9	Stormscope Symbols	18-10
Nearest	19	Appendix.....	19-1
	19.1	Glossary	19-1
Services/ Music	19.2	Datacard Information and Updates.....	19-9
	19.2.1	GTN Databases	19-9
Utilities	19.2.2	Updating Databases with an SD Card	19-11
	19.2.3	Updating Databases with a Flight Stream 510.....	19-13
System	19.2.4	Database SYNC.....	19-15
	19.2.4.1	Resolving Database SYNC Conflicts	19-16
Messages	19.2.5	Chart Streaming.....	19-16
	19.2.6	Database Troubleshooting Tips.....	19-17
Symbols	19.3	Demo Mode	19-18
	19.4	Glove Qualification Procedure	19-21
Appendix	19.5	Telligence Voice Command Qualification Procedure	19-25

Foreword

Getting Started

Audio & Xpdr Ctrl

Com/Nav

FPL

Direct-To

Proc

Charts

Wpt Info

Map

This page intentionally left blank

Traffic

Terrain

Weather

Nearest

Services/
Music

Utilities

System

Messages

Symbols

Appendix

Welcome

Welcome to the GTN era of navigation. The Garmin Touchscreen Navigator (GTN) supports airway navigation and flexible flight planning, including arrival and departure procedures and precision approaches. All of these advanced features are easily accessed with an easy-to-use touchscreen display, another first for general aviation. You can be confident in knowing that this product has been designed to meet or exceed industry performance standards and is supported through a global network of Garmin Aviation Distributors.

About This Guide

Take a little time to review the various sections of this guide to familiarize yourself with it. First, read this section and the Getting Started section as an introduction to quickly get you started with the GTN. The other sections are not meant to necessarily be read in order, but provide detailed information on the subject they contain as you need them. Do take the time to review the information before using the product to assist you in getting the most out of your avionics.

Generally, a feature will be described in a section that provides a brief description, a graphic functional diagram, and step-by-step procedures. If read cover-to-cover sequentially, the information may seem repetitive. The guide is designed as a reference and learning tool where you will generally skip around the document learning about a particular feature or function after becoming familiar with the unit.

Electronic Document Features

Versions of this guide are saved in the Adobe Portable Document Format (PDF) and have features that help the user navigate more easily through the document. The cover icons, table of contents, and index are hyperlinks that will take you directly to the selected item.

Versions of aviation products in PDF format are available at flyGarmin.com.

Conventions

Foreword

Getting Started

Audio & Xpdr Ctrl

Com/Nav

FPL

Direct-To

Proc

Charts

Wpt Info

Map

Traffic

Terrain

Weather

Nearest

Services/ Music

Utilities

System

Messages

Symbols

Appendix

The GTN display dynamically tailors the number and position of the controls for each function and are engaged by merely touching them.

Touch: Touch the key with your finger.

Drag: Touch the list or location on the map with your finger. Continue lightly holding your finger to the display surface and drag your finger in the intended direction to scroll through the list or move the location on the map.

In this pilot's guide, key titles are noted by bold text. An image of the key used will be shown to the left of a procedure. Keys are outlined areas on the display. Figures in the guide will identify the available controls. A key may have a name of a control, such as **Enter**, **Terrain**, or **Back**. A key may also be an information field, such as a numeric value that can be changed.

Graphic Of Key

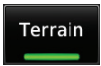

While viewing the Map Menu, touch the **Terrain** Map Overlay key to toggle the view of Terrain data.

Text Description Of Key Operation

Graphic Of Key With Numeric Value

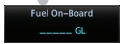

When the Fuel on Board value is selected, touch the **Fuel on Board** key to display the Fuel on Board values.

Text Description Of Key



List "Keys." Touch To Select.

Scroll Bar Indicates More Selections Available. Touch Finger To An Item In The List And Drag Your Finger To View More Selections.

Selected Field Type



Touching the **Back** key returns to the previous display. The **Cancel** key cancels any information selected or entered and returns to the previous display.

1 GETTING STARTED

1.1 Model Descriptions

This guide covers the operation of the GTN 725 and 750. In general, all models will be referred to as the GTN 7XX, except where there are physical or operational differences. The GTN units are 6.25 inches wide and 6 inches high. The display is a 708 by 600 pixel, 6.9 inch diagonal color LCD with touchscreen controls. The units include one removable SD datacard for the databases and software upgrades.

The GTN 7XX simplifies your workload with an easy-to-use touch panel that provides a visual display of both controls and functions. The required controls are displayed for the selected function. Keys on the display allow you to access and control their functions by a simple touch on the interactive display.

The GTN 7XX can integrate a variety of avionics that will not only simplify operation, but also save panel space. The GTN 725 and 750 have their own GPS/SBAS navigator and flight planning functions. The GTN 750 adds VHF Com and VHF Nav radios. Selected optional external equipment allows you to display and control active traffic systems, XM Entertainment Radio, XM Weather, audio panel, and a Mode S transponder directly from the GTN 7XX display, and more. When the optional audio panel and/or transponder are not installed, the area on the upper portion of the display is used for configurable navigation information.

1.1.1 GTN 725

The GTN 725 has a GPS/SBAS engine and is TSO C146c certified for primary domestic, oceanic, and remote navigation including en route, terminal, and non-precision approaches, and approaches with vertical guidance, such as LPV and LNAV/VNAV. The GTN 725 can simultaneously give aviators vital approach information and weather and traffic data in relation to their position on a large, color moving map display. Thanks to a high-contrast color display, the information can be easily read from wide viewing angles even in direct sunlight. Its color moving map features a built-in database that shows cities, highways, railroads, rivers, lakes, coastlines, and a complete Jeppesen database. The Jeppesen database (that can be updated with a front-loading datacard) contains all airports, VORs, NDBs, Intersections, FSSs, Approaches, DPs/STARs, and SUA information.

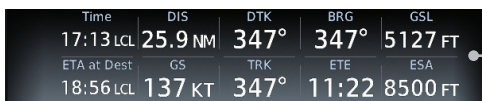

Navigation Information

Figure 1-1 GTN 725 Upper Display Without Optional Transponder or Audio Panel

Pilots will enjoy the GTN 725 as a flexible and powerful navigator, especially when it is coupled with traffic, lightning detection, and weather interfaces. With the PC-based FDE prediction program, the GTN 725 may be used for oceanic or remote operations. For the latest in graphic and text weather information, the GTN 725 can interface to XM Satellite Radio's XM Weather Service via the Garmin GDL 69/69A datalink receiver.

1.1.2 GTN 750

The GTN 750 includes all of the features of the GTN 725, and also includes a TSO'd airborne VHF communications transceiver and TSO'd airborne VOR/Localizer and Glideslope receivers.

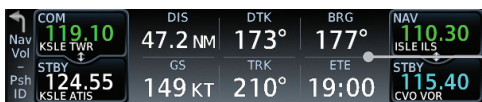

Navigation Information

Figure 1-2 GTN 750 Upper Display Without Optional Transponder or Audio Panel

1.2 About This Pilot's Guide

1.2.1 Conventions

Bold text indicates a control. The **small right** knob is the smaller, inner knob of the two concentric rotary knobs on the lower, right corner of the bezel. The **large right** knob is the larger, outer knob.

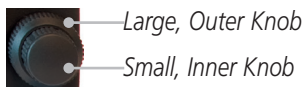

Figure 1-3 Large/Small Concentric Knobs

A graphic of a control on the side of the page refers to the control you should use for the associated step as shown below.

1.2.2 Using the Touchscreen

Most of the controls are operated by touching the display. Highlighted icons and keys may be simply touched to make a selection. A list of menu items may be scrolled by touching the screen and retaining pressure while sliding your finger up or down. Map displays may be panned by touching the screen

and retaining pressure while sliding your finger in the desired direction. Pinch-to-zoom capability is available in software v6.20 or later.



You can return to the previous page or exit the current function by touching the **Back** key.



Quickly return to the Home page by pressing the **HOME** key. Press and hold the **HOME** key to reach the Map page.

1.3 Product Description

This section provides an overview of the GTN 7XX product and a quick look at some important features. The GTN 7XX presents a full-color moving map with navigation information to the pilot through a large-format display. Controls are a combination of rotary knobs and push-keys on the bezel with the color display providing information as well as a touchscreen controls. The GTN 7XX has a 708 x 600 pixel, 6.9 inch LCD display.

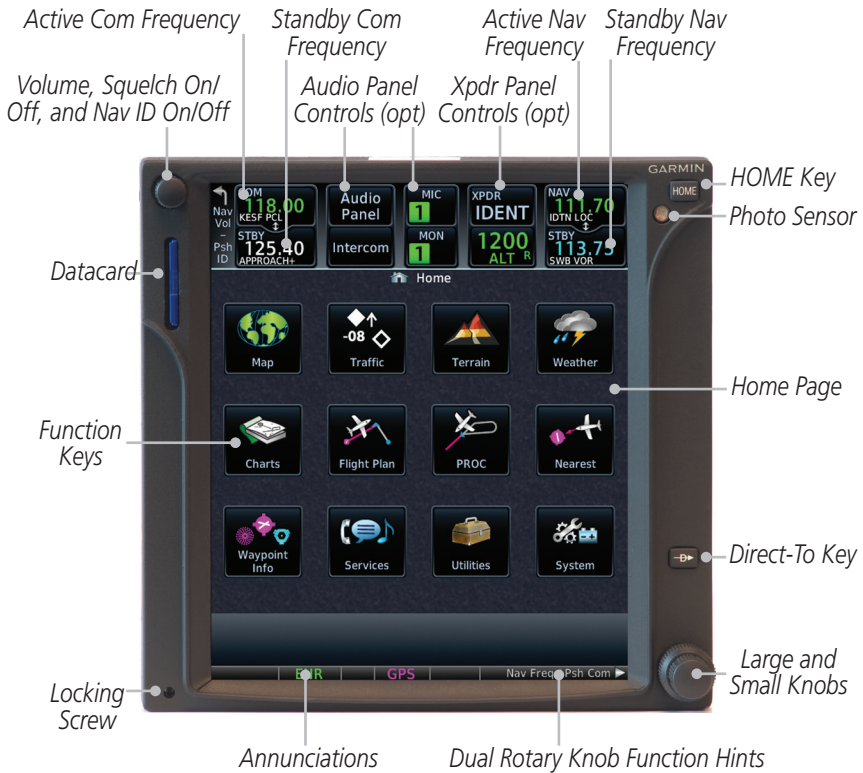

Figure 1-4 GTN 750 Front Panel

1.3.1 Datacard

The GTN 7XX uses a Secure Digital (SD) card or Flight Stream 510 to load and store various types of data. The datacard is required for Terrain, FliteChart, and ChartView database storage and all database updates.



NOTE: Do **Not** remove or insert the datacard while in flight. Ensure the GTN 7XX is powered off before inserting or removing a datacard.



NOTE: For instructions on updating databases refer to section 19.2.

1.3.1.1 Inserting a Datacard

1. Insert the datacard in the datacard slot (the label side of the card should face the right edge of the display bezel).
2. To eject the card, gently press on the datacard to release the spring latch.

1.3.2 Pilot Controls

The GTN 7XX controls have been designed to simplify operation of the system and minimize workload and the time required to access sophisticated functionality. Controls are located on the bezel and on the touchscreen display. Controls are comprised of dual concentric knobs, volume/squelch knob, bezel keys, and active touch areas on the display.

1.3.2.1 Volume/Squelch Knob

The **Volume** knob located in the top left corner of the bezel controls audio volume for the selected Com radio or Nav receiver and external audio input devices that are controlled via the GTN interface to the optional remote-mounted audio panel, if installed. When the Com radio is active, press the **Volume** knob momentarily to disable automatic squelch control for the Com radio. When the Nav radio is active, press the **Volume** knob momentarily to enable/disable the ident tone for the Nav radio.



Figure 1-5 Volume/Squelch Knob

1.3.2.2 Large/Small Concentric Knobs

The **large right** and **small right** knobs are used for data entry, such as in the Waypoint or Direct-To functions, and to set the frequencies for the NAV/COM radios in units so equipped.



Figure 1-6 Large/Small Concentric Knobs

1.3.2.3 HOME Key

Pressing the **HOME** key displays the Home page, the main screen for accessing the GTN features. Pressing and holding the **HOME** key will open the Map page from any other page.



Figure 1-7 HOME Key

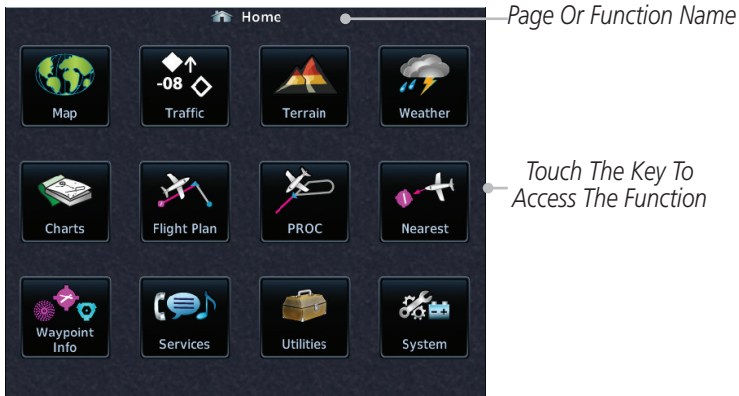

Figure 1-8 Home Page

1.3.2.4 Direct-To Key

The **Direct-To** key provides access to the direct-to function, which allows you to enter a waypoint and establishes a direct course to the selected destination.



Figure 1-9 Direct-To Key

1.3.2.5 Touchscreen Keys

Touchscreen keys are placed at the lower portion of the display. The keys vary depending on the page selected. Touch the key to perform the function or access the described information.



Figure 1-10 Touchscreen Key Control Example

1.4 Unit Power Up

The GTN 7XX System is integrated with the aircraft electrical system and receives power directly from electrical buses. The GTN 7XX and supporting sub-systems include both power-on and continuous built-in test features that exercise the processor, memory, external inputs, and outputs to ensure safe operation.

1.4.1 Start-Up Screens

During system initialization, test annunciations are displayed. All system annunciations should disappear typically within the first 30 seconds after power-up. Upon power-up, key annunciator lights also become momentarily illuminated on the GTN 7XX display bezel.

The splash screen displays the following information:

- Copyright
- Database List and System version
- Instrument Panel Self-Test

Currently installed database information includes valid operating dates, cycle number, and database type. When this information has been reviewed for currency (to ensure that no databases have expired), the pilot is prompted to continue. Databases that are not current will be shown in amber.

During the startup process the user may be asked if they would like to update to newer databases. Additional information on database updates can be found in 19.2.

The COM and NAV radios, transponder controls, GDL 88 control panel, and audio panel controls are displayed on the Start-Up screens. Some functions may be unavailable until after the databases are verified. Also, the audio panel controls may be temporarily unavailable until the GMA 35 has finished its

start-up process.

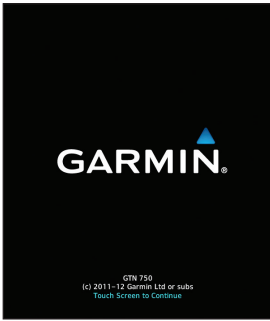

1 - Copyright



2 - SW & Database Versions & Dates



3 - Panel Self-Test

Figure 1-11 System Startup Pages

1.4.2 Database Verification and Fuel Settings

Continue

1. When the System and Database Version page appears, ensure databases are current. Then, touch **Continue**.



Figure 1-12 System Startup Pages

2. When the Instrument Panel Self-Test and Fuel Setting page appears, ensure that the CDI/HSI outputs and other displayed data are correct on the external interfaced equipment.

Foreword

Getting Started

Audio & Xpdr Ctrl

Com/Nav

FPL

Direct-To

Proc

Charts

Wpt Info

Map

Traffic

Terrain

Weather

Nearest

Services/Music

Utilities

System

Messages

Symbols

Appendix

- Touch each of the Fuel value keys and set the appropriate values as desired. Fuel capacity units are selected on the System - Units page.

NOTE: When the GTN is interfaced with a digital fuel computer the pilot may not be able to manually edit the fuel flow and fuel on board data on the Self-Test.



Start-Up
Instrument
Panel Test
Conditions

Touch To Set
Current Fuel
Quantity

Touch To Set
Fuel Flow

Touch To Continue
To Home Page

Figure 1-13 Instrument Panel Self-Test & Fuel Settings Page

- When the Fuel on Board value is selected, touch the **Full** or **Tabs** keys to display those values after they have been set.

Fuel On-Board
GAL

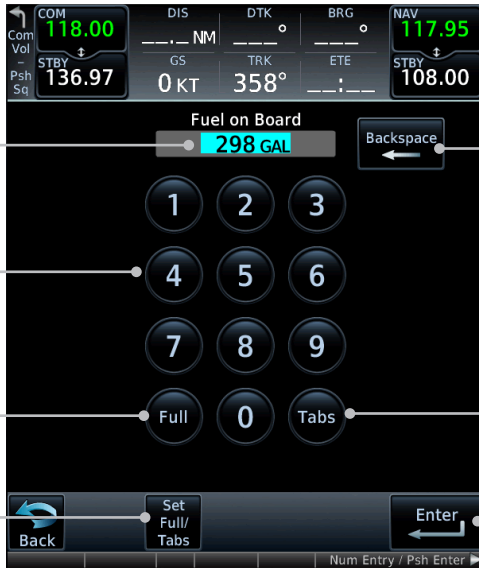

Figure 1-14 Fuel On Board Page

5. Touch the **Set Full/Tabs** key to set the fuel values for Fuel Full Capacity and Fuel Tab Capacity. After setting the fuel values, touch the **Back** and then the **Enter** keys to return to the Instrument Panel Self Test page.



Figure 1-15 Fuel Capacity Setup Page

- On the Instrument Panel Self Test page, touch the **Fuel Flow** key and then use the numeric keypad to set those values. Touch the **Enter** key after selecting the Fuel Flow values.

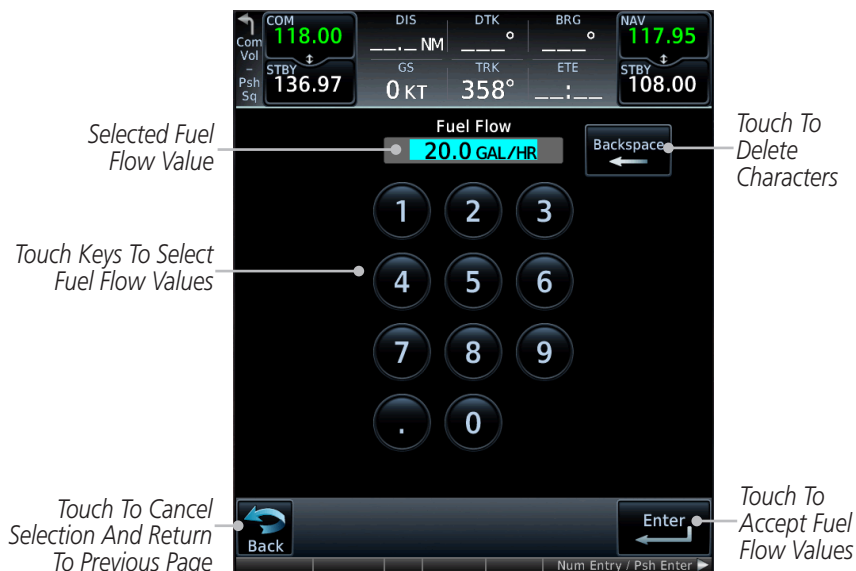

Figure 1-16 Fuel Flow Setup Page

Continue

- Touch the **Continue** key to advance to the Home page.

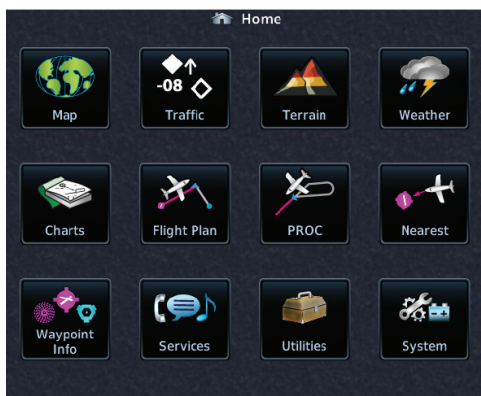

Figure 1-17 Home Page

1.5 System Operation

1.5.1 Using the Touchscreen Key Controls

Except for the knobs, the **HOME**, and **Direct-To** keys on the bezel, the controls for the GTN 7XX are located on the display and activated by touch.



Figure 1-18 On-Screen Keys and Active Display Areas

1.5.2 System Page

GTN 7XX system settings are managed on the System page. The following features are available:

- System Status
- GPS Status
- External LRUs
- Setup
- Alerts Settings
- User Fields
- Units Settings
- Audio
- Backlight
- Connex Setup
- Voice Commands

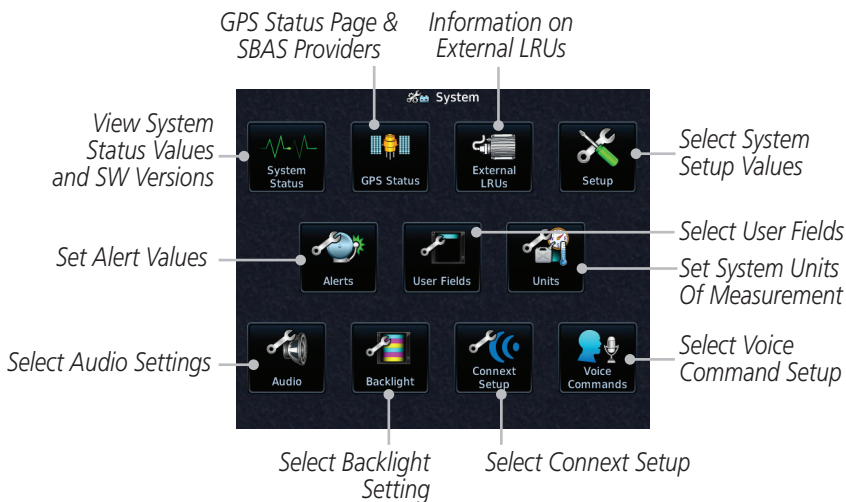
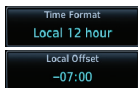

Figure 1-19 System Page

1.5.2.1 System Setup Values

1. From the Home page, touch **System** and then **Setup**.



2. Select the desired Time Format and Local Offset by touching the Time Format (**12 Hour**, **24 Hour**, and/or **UTC**) keys and selecting the appropriate Local Time Offset after touching the **Local Offset** key.



3. Touch the **Com Channel Spacing** key to toggle between 8.33 and 25.0 kHz channel spacing.



4. For Nearest Airport filtering, touch the **Runway Surface** key and select the desired type of surface that will appear in the Nearest Airport list.



5. Touch the **Minimum Runway Length** key to select the minimum runway length allowed for the Nearest Airport. Selecting 0 feet will show all airports regardless of runway length.

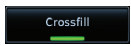

6. Touch the **Crossfill** key to enable or disable crossfill with a second GTN unit.



7. Select the CDI and ILS CDI Capture method with the **Selected CDI** and **ILS CDI Capture** keys.



1.5.2.2 Units Settings Values

1. From the Home page, touch **System** and then **Units**.



2. Touch the desired item key and select the desired value.
3. Continue to select the desired Units values and then touch the **Back** or **HOME** key to exit.

1.5.2.3 Alerts Settings Values

1. From the Home page, touch **System** and then **Alerts**.



2. Touch the Alert type key to toggle its active status. A lighted green bar under the label indicates that it is active.
3. Set arrival alerting. Touch the **Arrival** key. Touch the **Proximity** key and select the desired value with the keypad.
4. Touch the **Airspace Altitude Buffer** key and select the desired value for airspace alerting.
5. Continue to select the desired Alerts values and then touch the **Back** or **HOME** key to exit.

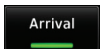

1.5.2.4 Audio Values

1. From the Home page, touch **System** and then **Audio**.
2. Touch the **arrow** keys to raise or lower the volume of key click sounds.

1.5.2.5 Backlight Values

1. From the Home page, touch **System** and then **Backlight**.
2. Touch the **arrow** keys to increase or decrease the Manual Offset of the backlight brightness.

1.5.2.6 Connex Setup

1. From the Home page, touch **System** and then **Connex Setup**.
2. This page is used to setup Connex devices that are connected to the GTN.

1.5.2.7 Voice Commands

1. From the Home page, touch **System** and then **Voice Commands**.
2. This page is used to turn voice recognition on or off, and to view voice command history.

Foreword

Getting Started

Audio & Xpdr Ctrl

Com/Nav

FPL

Direct-To

Proc

Charts

Wpt Info

Map

Traffic

Terrain

Weather

Nearest

Services/
Music

Utilities

System

Messages

Symbols

Appendix

1.5.3 Dual GTN Installations

Dual GTN units when connected in the aircraft may be set up to communicate and share information by “Crossfilling” or synchronizing information between the two units.

The following Crossfill information is always synchronized between both GTN units:

- User Waypoints
- Flight Plan Catalog
- Alerts (traffic pop-up acknowledgement, missed approach waypoint pop-up acknowledgement, altitude leg pop-up acknowledgement)
- External sensors (transponder status and commands, synchro heading)
- System setup:
 - User-defined NAV frequencies to store favorites
 - Date/Time convention
 - Nearest airport criteria
 - Units (Nav angle, Fuel, and Temperature)
 - User-defined COM frequencies to store favorites
 - CDI Scale setting
 - ILS CDI Capture setting

This data is crossfilled only if crossfill is turned on by the pilot:

- Active navigation (flight plan)



NOTE: *In dual GTN installations with crossfill on, the OBS course will only be updated in real time on the GTN that is receiving the new OBS course. The course will be transferred to the other GTN when OBS is exited.*



NOTE: *There is an installer option to turn on a system message that will be provided anytime crossfill is turned off to alert the pilot that flight plans are not being crossfilled.*

1.6 Direct-To Navigation

Press the **Direct-To** key to quickly navigate from your present position directly to a selected waypoint, flight plan waypoint, or nearest airport.

1.6.1 Direct-To a Waypoint



1. Press **Direct-To**.
2. Touch the Waypoint Identifier field and select the characters for the desired waypoint with the **large** and **small right** knobs or the touch keypad.
3. Touch **Activate** or press the **small right** knob. Text near the **small right** knob indicates its current function.



OR



1.6.2 Direct-To a Flight Plan Waypoint



1. Press **Direct-To**.
2. Touch the **FPL** tab and then the desired Flight Plan waypoint.
3. Touch **Activate** or press the **small right** knob.



OR



1.6.3 Direct-To a Nearest Airport



1. Press **Direct-To**.
2. Touch the **NRST APT** tab and then the desired airport from the Nearest Airport list. Touch the **Up** or **Down** keys as needed to show more of the list.
3. Touch **Activate** or press the **small right** knob.



OR



1.7 Selecting Com/Nav Frequencies

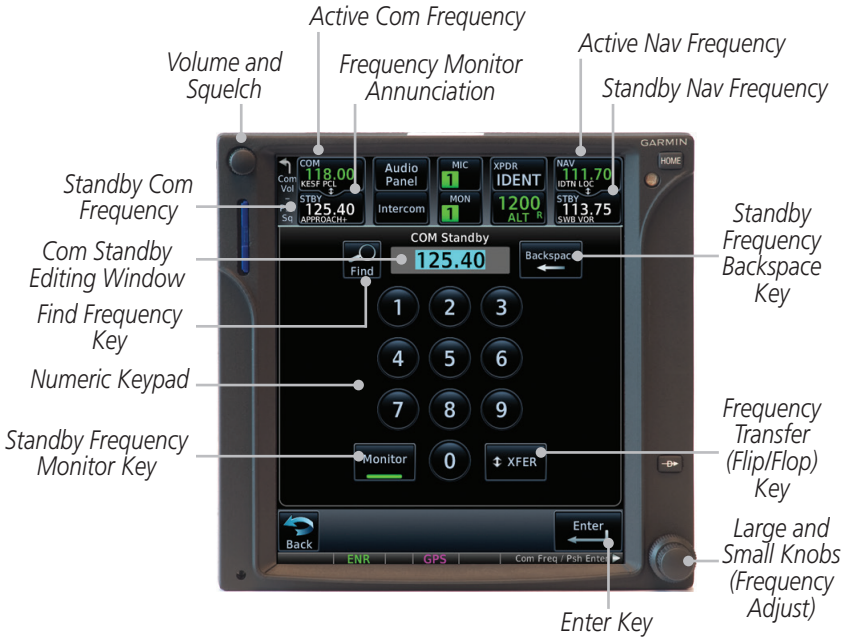

Figure 1-20 Com Radio Frequency Selection Page

To switch between Com and Nav frequency selection

Tuning control normally remains in the Com window and will return after 30 seconds of inactivity. If you wish to select a Nav frequency, press the **small right** knob momentarily to make the Nav window active for editing. The Standby Nav frequency will be highlighted briefly to indicate that it is active for editing. The standby frequency in blue is active for editing by the **large** and **small right** knobs.

Method 1: Select a Nav/Com frequency using the small and large right rotary knobs



1. Turn the **large right** knob to select the desired megahertz (MHz) value. For example, the "118" portion of the frequency "118.30."
2. Turn the **small right** knob to select the desired kilohertz (kHz) value. For example, the ".30" portion of the frequency "118.30."
3. Touch the Com or Nav window to flip/flop the Active and Standby frequencies. You can also press and hold the **small right** knob

to transfer the standby frequency to the active window.

Method 2: Select a Nav/Com frequency using the numeric keypad

1. Touch the Standby window. A pull down keypad will appear with the current Standby frequency highlighted.
2. Touch the numeric keys to add the desired values and touch **Enter** to accept the displayed value and place it into the Standby window.
3. Touching the **XFER** key will place the selected frequency directly into the Active window.



To transfer the standby frequency to the active frequency

1. Touch the Active (top) frequency window.

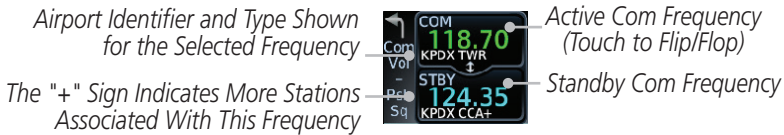

Figure 1-21 Com Radio Frequency Windows (Touch Active to Flip/Flop)

2. Each touch of the Active window will flip/flop the Active and Standby frequencies.
3. The identifier and frequency type will be shown for the selected Com and Nav frequencies for the nearest stations that are in the database when the unit is receiving a valid position input.

Remote Frequency Selection Control

On units configured for remote Com frequency Recall, pressing the remote recall switch will load the next preset Com frequency into the unit's Standby frequency window. The remote recall switch can be pressed multiple times to scroll the entire preset frequency list through the Standby frequency box (the list will "wrap" from the bottom of the list back up to the top, skipping any empty preset positions).

The standby frequency isn't activated until a Com **FLIP/FLOP** switch (either bezel-mounted or remote (COM RMT XFR) is pressed. Remote Frequency Selection only functions on units configured for a remote Com Frequency recall switch.

NOTE: Frequencies must be stored in the User Frequency List prior to utilizing the remote channel select switch.



1.8 Flight Planning

1.8.1 Creating a Flight Plan

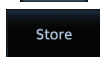
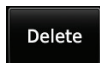

1. From the Home page, touch the **Flight Plan** key. The Active Flight Plan page will be displayed.
2. If there is already an Active Flight Plan, touch **Menu** and then the **Delete** key to clear the existing flight plan. If there is not an Active Flight Plan, continue to the next step.
3. Touch **Add Waypoint**. Use the alphanumeric keypad to select the Waypoint Identifier for the first leg in your flight plan and then touch **Enter**.
4. Touch the next Waypoint Identifier field. Use the alphanumeric keypad to select the Waypoint Identifier for the first leg in your flight plan and then touch **Enter**.
5. Continue entering waypoints to complete the flight plan.
6. Touch the **Menu** key and then touch **Store**.
7. The screen will now display the Flight Plan Catalog and show the new flight plan. Flight plans are listed by the Departure and Destination waypoints.

NOTE: *The destination waypoint is the last airport in the flight plan.*

1.9 VFR and IFR Procedures

Visual approaches and IFR procedures (i.e., SIDs, STARs, and instrument approaches) are available using the **PROC** (Procedures) key.

1.9.1 Select a Visual or Instrument Approach



1. Touch the **PROC** key on the Home page.

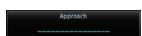

2. Touch the **Approach** key and then touch the Airport key to select the desired airport if it is not present.

3. Touch the **Approach** key, if necessary. Select the desired approach.

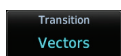

4. Touch the **Transition** key and then touch the key for the desired transition. Visual approaches do not have selectable transitions.



5. Touch the **Load Approach** key to load the approach at the end of the active flight plan. The Active Flight Plan page will be displayed.



6. Or, touch the **Load Approach & Activate** key for the flight plan to go Direct-To the selected transition or provide guidance on the final approach course for vectored or visual approaches.

- Foreword
- Getting Started
- Audio & Xpdr Ctrl
- Com/Nav
- FPL
- Direct-To
- Proc
- Charts
- Wpt Info
- Map
- Traffic
- Terrain
- Weather
- Nearest
- Services/ Music
- Utilities
- System
- Messages
- Symbols
- Appendix

1.10 Dead Reckoning

Dead reckoning is a feature that enables the GTN to provide limited navigation using the last known position and speed after a loss of GPS navigation while on an active flight plan.



CAUTION: *Navigation using dead reckoning is only an estimate and should not be used as the sole means of navigation. Use other means of navigation, if possible.*

Dead reckoning becomes active after a loss of GPS position while navigating using an active flight plan and the flight phase is either En Route (ENR) or Oceanic (OCN).

“DR” will be overlaid on the ownship icon. The To/From flag is removed from the CDI. The Dead Reckoning annunciator (DR) appears on the lower left side of the map display and will replace ENR or OCN when a GPS position is unavailable and the unit is in Dead Reckoning mode. All external outputs dependent on GPS position are flagged.

Terrain will be noted as not available and new terrain advisory pop-ups will not occur. Traffic and StormScope information will not be shown on the Map page, but will continue to be available on their own dedicated pages. XM weather will still be available on the Map page.

Dead Reckoning mode will continue until GPS position is restored, when GPS navigation is restored Dead Reckoning mode is exited. The DR annunciations will be removed and GPS information will be used to compute navigation related information for the current flight phase.

Dead Reckoning is only allowed in En Route and Oceanic phases of flight. If the unit is in a Terminal or Approach phase of flight when Dead Reckoning takes place, “No GPS Position” will be displayed on the map pages and all navigation data will be dashed. If you are operating in Dead Reckoning mode and a transition to Terminal or Approach phases of flight would occur from the projected Dead Reckoning position, Dead Reckoning mode will be discontinued. “No GPS Position” will be displayed on the map pages and all navigation data will be dashed. For information about GPS faults, refer to 16.2.4.

1.11 FastFind Predictive Waypoint Entry

FastFind provides the pilot with a shortcut to the nearest waypoint with an identifier that starts with the typed letters. As a result, the GTN can predict the pilot's entry within as little as one key press.

FastFind predictions are shown in the top right-hand corner of the keypad display. Touching the FastFind field will select the predicted waypoint. If the FastFind prediction is not what the pilot is looking for, keep typing until the desired waypoint is displayed.

1.11.1 FastFind With Waypoint Info

1. Use the alphanumeric keypad to begin selecting characters for the desired waypoint.

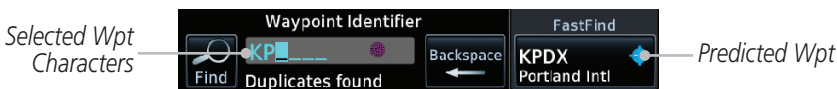

Figure 1-22 Select Characters for FastFind to Predict a Waypoint - KP Selected



Figure 1-23 Select Characters for FastFind to Predict a Waypoint - KPA Selected

2. After selecting the desired waypoint, touch the **FastFind** key.

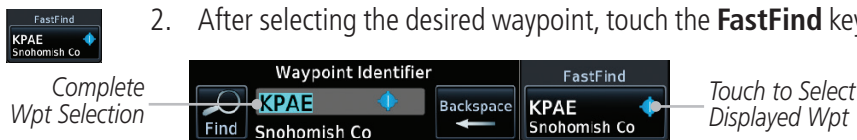

Figure 1-24 Select Characters for FastFind to Predict a Waypoint - KPAE Selected

1.11.2 FastFind With A Flight Plan

When creating a new flight plan or searching for a waypoint, the GTN will search for waypoints closest to the current GPS position. When adding waypoints in the middle of the flight plan, the GTN will search halfway between the previous and next waypoints. When adding waypoints at the end of the flight plan, the GTN will search for waypoints closest to the last waypoint in the flight plan.

1. When the aircraft is located in KSLE, and the last waypoint in the flight plan is "DRK," the GTN will search for waypoints nearest "DRK."
2. Typing **K**, will result in "KPRC" being displayed as the FastFind prediction because it is the nearest waypoint to "DRK" that starts with "K."



Figure 1-25 Using FastFind to Predict a Waypoint in a Flight Plan

Foreword

Getting Started

Audio & Xpdr Ctrl

Com/Nav

FPL

Direct-To

Proc

Charts

Wpt Info

Map

This page intentionally left blank

Traffic

Terrain

Weather

Nearest

Services/
Music

Utilities

System

Messages

Symbols

Appendix

2 AUDIO AND TRANSPONDER CONTROLS (OPTIONAL)

The GTN 7XX can perform the control and display for a remotely mounted audio panel (such as the GMA 35) and a transponder (such as one of the GTX family of transponders) functions. See your dealer for more information.

2.1 Transponder Operation



NOTE: The transponder control panel on the GTN will only contain the Ground key when the GTN is interfaced with a GTX 33/330 with software versions prior to 8.00.



NOTE: Starting the GTN with a Flight Stream 510 wireless datacard in the slot may cause the control panel to be temporarily unavailable on the start-up screens during unit power up.

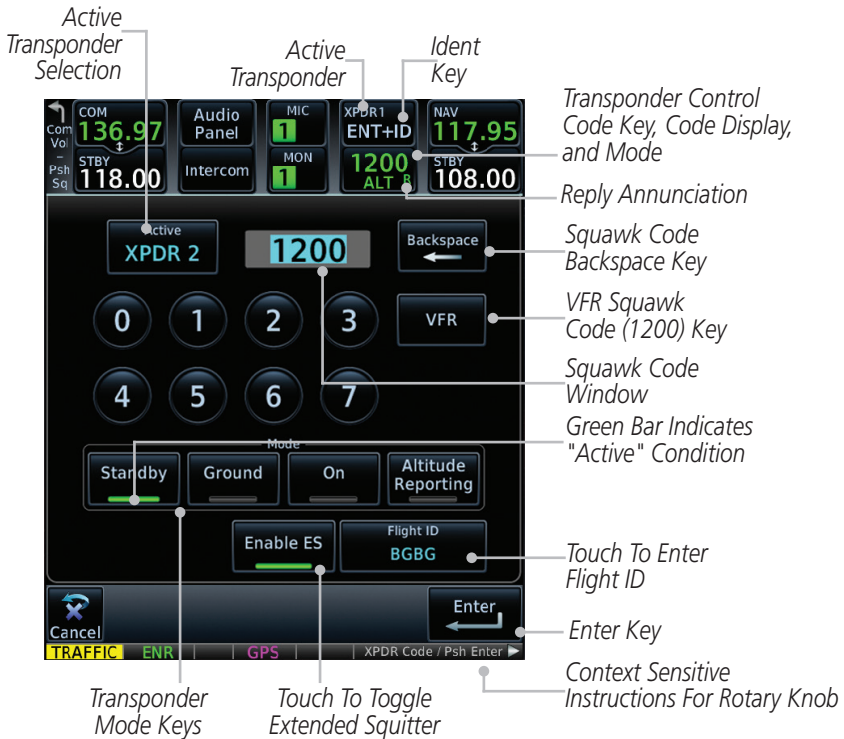

Figure 2-1 XPDR Control Display

The GTN 7XX will operate as a control head for remotely connected optional, compatible transponders.

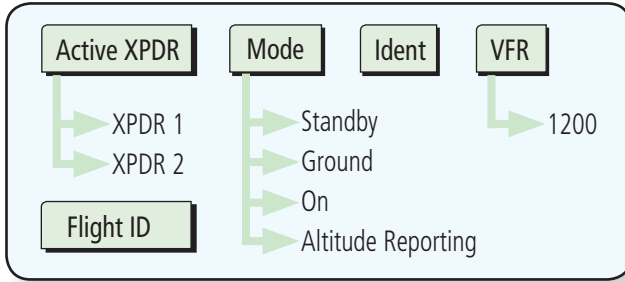
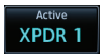

Figure 2-2 XPDR Functional Diagram

2.1.1 Select Transponder



1. Touch the **Active XPDR** key to activate the desired transponder by stepping through the available transponders.



Figure 2-3 Active Transponder Indication



2. The active transponder will be shown on the key.

2.1.2 IDENT



1. Touch the **IDENT** key once to reply with an identifying squawk code.



2. The **IDENT** key will show a green "ID" in the top right corner of the key to indicate active Ident.

2.1.3 Standby

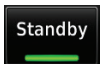

Touch the **Standby** key to place the transponder into Standby mode. The transponder will still be powered, but will not transmit information. The active transponder indication and Ident annunciation will be grayed to show they are disabled.

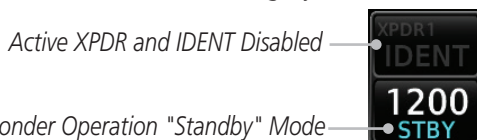
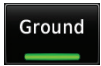

Figure 2-4 Transponder Mode "Standby" Indication

Foreword
Getting Started
Audio & Xpdr Ctrl
Com/Nav
FPL
Direct-To
Proc
Charts
Wpt Info
Map
Traffic
Terrain
Weather
Nearest
Services/Music
Utilities
System
Messages
Symbols
Appendix

2.1.4 Ground



Touch the **Ground** key to place the transponder into Ground mode. Mode S replies will be allowed in Ground mode.

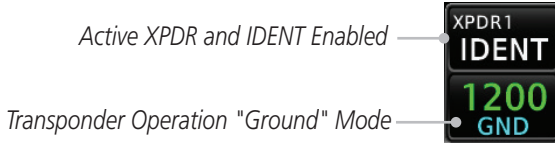
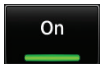

Figure 2-5 Transponder Mode "Ground" Indication



NOTE: The transponder control panel on the GTN will only contain the Ground key when the GTN is interfaced with a GTX 33/330 with software versions prior to 8.00. With all other GTX software versions, the transponder will automatically transition out of airborne mode.

2.1.5 On



Touch the **On** key for Mode A operation. The transponder is "On" and will transmit its squawk code when interrogated.



Figure 2-6 Transponder Mode "ON" Indication

2.1.6 Altitude Reporting

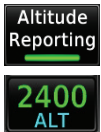

1. Touch the **Altitude Reporting** key for Mode C operation.
2. The transponder will be "On" and will transmit its squawk code and altitude when interrogated. An "ALT" annunciation will appear when the squawk code is transmitted.

2.1.7 VFR



Touch the **VFR** key to set the VFR squawk code (1200).

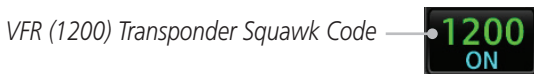

Figure 2-7 Transponder VFR Squawk Code

2.1.8 Selecting a Squawk Code

The selected squawk code will always be in use. As you change a squawk code, the original code will be used until you are finished selecting the new code.

Squawk Code	Description
1200	Default VFR code in the USA
7500	Hijacking
7600	Loss of Communications
7700	Emergency

Table 2-1 XPDR Special Squawk Codes



1. Touch the transponder squawk code window at the top of the display.
2. The XPDR page will be displayed. The Squawk Code value will be active for selection for use by the active Transponder.



Figure 2-8 XPDR Squawk Code Selection Display

3. Touch the numeric keypad, or use the rotary knobs, to select the desired Squawk Code.



Figure 2-9 Selected XPDR Squawk Code



4. Then, touch **Enter** or press the **small right** knob.



5. The selected Squawk Code will be shown in the XPDR window at the top of the display.

2.1.9 Flight ID



1. While viewing the transponder page, touch the **Flight ID** key.



2. Touch the numeric keypad, or use the rotary knobs, to select the desired Flight ID number and then press **Enter**. The selected number will be shown in the Flight ID key.



2.1.10 GDL 88 ADS-B Reporting

The GDL 88 is a remote-mount ADS-B transceiver that sends ADS-B out messages to ATC and other aircraft and communicates ADS-B In data to panel-mounted avionics for the display of traffic and weather. Reference the GDL 88 Pilot Guide for a full description of GDL 88 functions. When a GTN is interfaced to a GDL88 transceiver for ADS-B Out functions the GTN can control some aspects of the ADS-B Out message and the GTN may provide position information to the GDL88. The display and control of the information sent depends on the equipment installed and how it is configured. Some installations allow control by the pilot of the information sent, while others do not.

The Anonymous Mode, when armed, will replace the identifying information in the ADS-B Out message with a temporary randomized number for privacy while the position information will still be provided. The call sign will be sent as "VFR." To enable Anonymous Mode, the Squawk Code must be set to the VFR code (based on the GDL 88 configuration) and the **Anonymous** key must be selected.

Viewing the ADS-B Control Panel Without Integrated Transponder Control

Foreword

Getting Started

Audio & Xpdr Ctrl

Com/Nav

FPL

Direct-To

Proc

Charts

Wpt Info

Map

Traffic

Terrain

Weather

Nearest

Services/Music

Utilities

System

Messages

Symbols

Appendix

Index

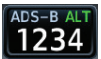

1. Touch the Transponder window to view the ADS-B control panel.



Figure 2-10 ADS-B Control Panel

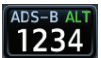

2. Touch the ADS-B window again to return to the previous display.

Viewing the ADS-B Control Panel With Integrated Transponder Control



1. Touch the Transponder window to view the ADS-B control panel.



Figure 2-11 ADS-B/Transponder Control Panel

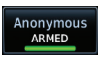

2. Touch the **Anonymous Mode** key to toggle arming the Anonymous mode.

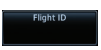

3. While viewing the transponder page, touch the **Flight ID** key.



4. Touch the numeric keypad, or use the rotary knobs, to select the desired Flight ID number and then press **Enter**.





NOTE: Changing the flight ID while in anonymous mode wouldn't actually change the flight ID because a randomized ID is being broadcast. If the ANONYMOUS key is armed, change the squawk code to the VFR code to activate Anonymous mode.

2.1.11 Extended Squitter Transmission

When interfaced with a compatible transponder, the GTN can act as a control for the Extended Squitter functions. When "Enable ES" is selected, the GTX turns on Extended Squitter (ES) transmissions.

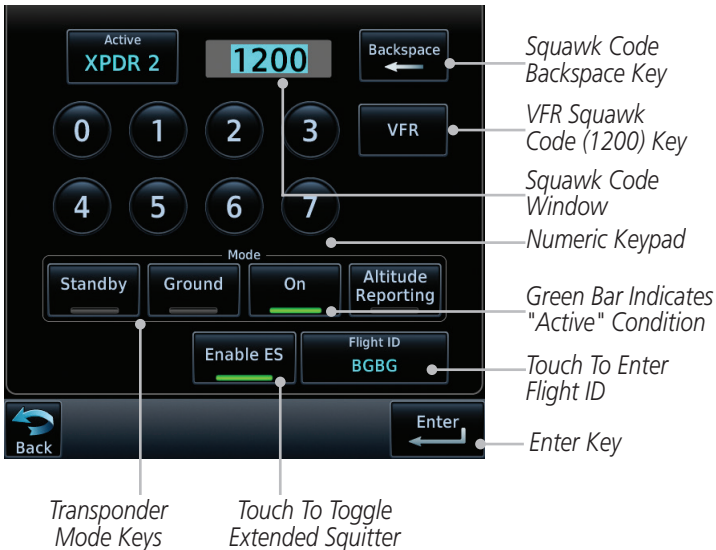
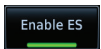
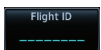

Figure 2-12 Transponder Control Panel With Extended Squitter Capability



1. While viewing the Transponder (XPDR) page, touch the **Enable ES** key to toggle Extended Squitter Off and On.



2. Touch the **Flight ID** key and use the keypad to select a Flight ID and then touch **Enter**.

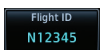

3. After selecting a Flight ID, the selected value will be shown in the **Flight ID** key.

2.1.12 TCAS II Transponder Mode Controls



NOTE: This feature is available in software v6.30 and later.

The GTN can control the modes of a TCAS II system through a GTX 3000. The TA Only and TA/RA modes are added to the transponder control panel. Selecting TA Only or TA/RA will command the TCAS into the selected mode. Depending on the aircraft configuration (e.g., on ground), the TCAS may remain in a different mode.



Figure 2-13 TCAS II Transponder Control Panel



NOTE: The XPDR/TCAS Mode on the Transponder Control Panel always shows the pilot-selected mode and does not necessarily correspond with the traffic system if it is in a lower mode due to other constraints. The active mode is shown in the radio bar next to the transponder squawk code.

XPDR/TCAS Mode Selection	Transponder Mode	Available TCAS II Modes
TA/RA	Altitude Reporting	TA/RA or TA Only
TA Only	Altitude Reporting	TA Only
Altitude Reporting	Altitude Reporting	Standby
On	On	Standby
Standby	Standby	Standby

Table 2-2 Transponder and TCAS II Operating Modes

2.1 Audio Panel Operation

The GTN 7XX can operate as a control head for remotely connected compatible audio and intercom equipment (such as the GMA 35).

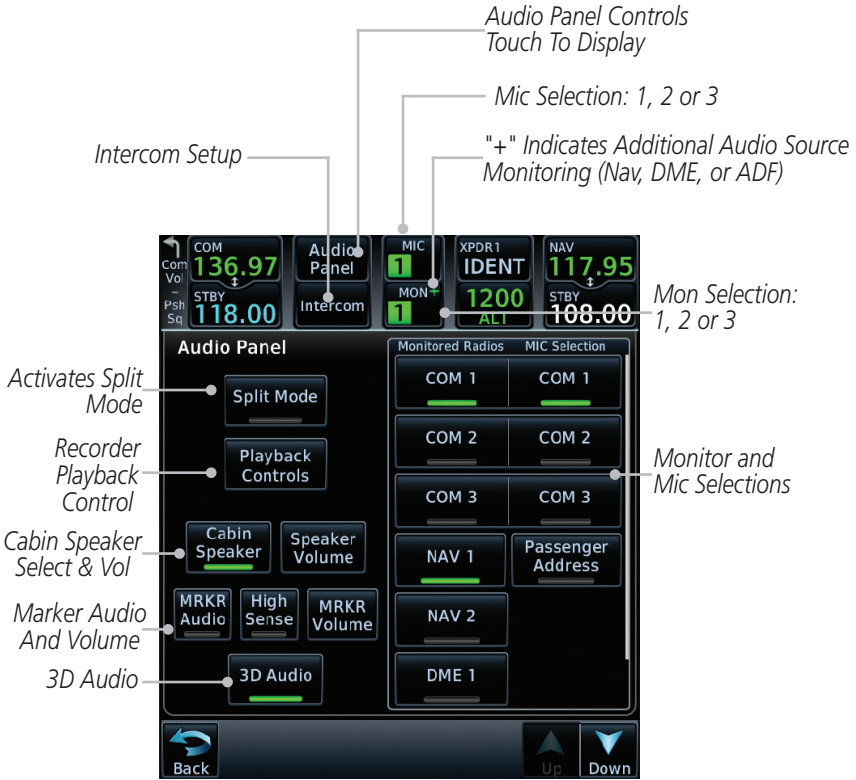

Figure 2-14 Audio Panel Controls

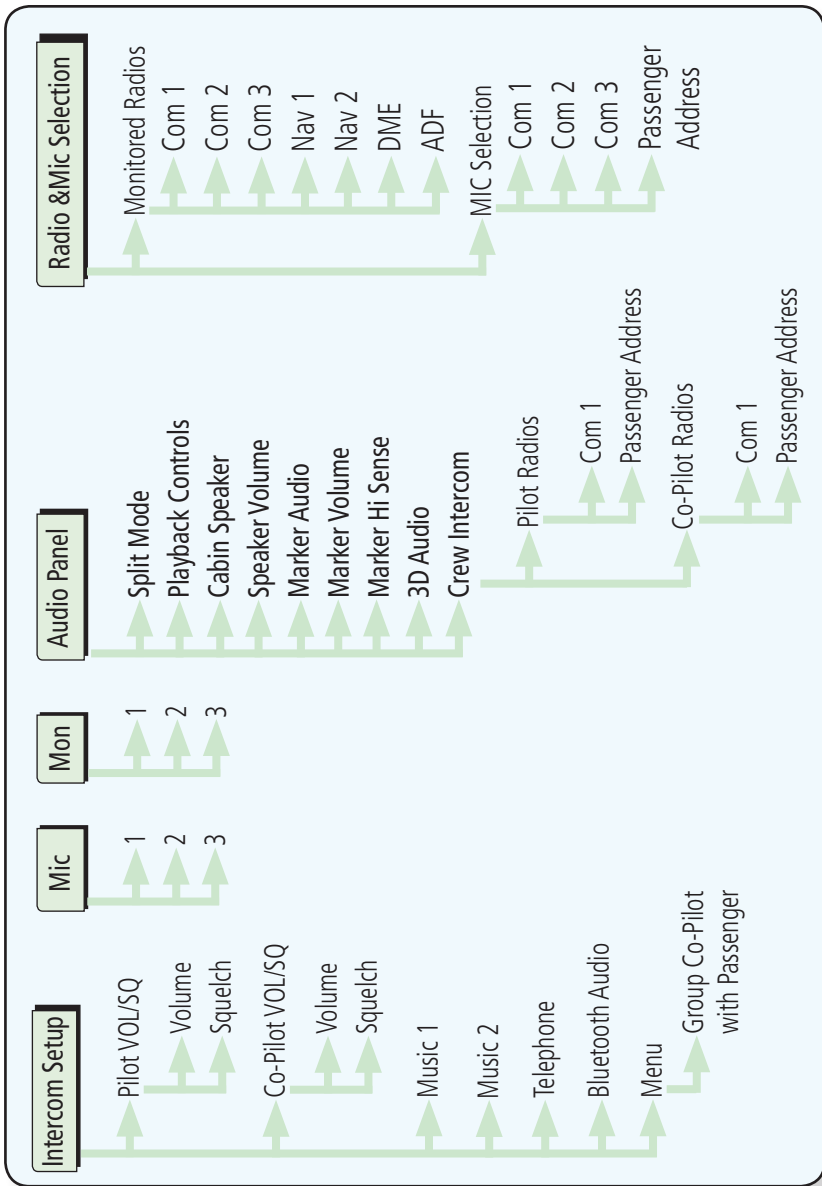

Figure 2-15 Audio Panel Functional Diagram

2.1.13 Mic Selection

Mic selection can be determined by two methods: the Mic window or by the Audio Panel page.

2.1.13.1 Mic Window Mic Selection



1. Touch the **Mic** window to toggle between Mic 1 and Mic 2.
2. Note that the selected Mic is automatically monitored.
3. If Mic 3 or Passenger Address (PA) are selected, touching the Mic window will revert to toggling between Mic 1 and Mic 2.

2.1.13.2 Audio Panel Page Mic Selection



1. Touch the **Audio Panel** key at the top of the display.



Figure 2-16 Audio Panel MIC Selection

2. Touch the desired Mic (Com 1, Com 2, or Com 3) from the MIC Selection list on the right side of the display.
3. The selected Mic will be shown in the Mic window.

2.1.14 Monitor

The Monitor function indicates which radios are being listened to.



1. Monitor is automatically selected for the associated Com Mic Radio (1, 2, or 3). For example, when Com 1 is selected, Mon 1 is automatically active.



2. Touch the **Mon** key to toggle between the automatically selected monitored channel (selected Mic) and the other channels.

2.1.15 Passenger Address

The **Passenger Address** key toggles the passenger address system on and off.



Touch the **Passenger Address** key to toggle the passenger address system on and off.

2.1.16 3D Audio

Advanced processing adjusts audio in the headset to mimic how the human ear normally hears and registers sounds in space. This 3-D Audio feature makes it seem as though different audio sources are coming from different directions around you. Now it's much easier to focus on and understand one particular source from among many. For example, COM 1 will seem to be coming from the left while COM 2 will seem to be coming from the right. When 3D Audio is disabled, balance is restored.



NOTE: *The stereo/mono headsets must be in the stereo position in order for 3D audio to function.*

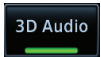

Touch the **3D Audio** key to toggle the 3D Audio function on and off.

This is currently done such that audio sources will either be 30 degrees to your left (330 degrees), 30 degrees to your right, and directly in front (0 degrees). The following table details the left/right balance of the audio level depending on the selected Com:

Active Com	1	2	3
1,2,3	330	0	30
1,2	330	30	N/A
1,3	330	N/A	30
2,3	N/A	330	30
1	0	N/A	N/A
2	N/A	0	N/A
3	N/A	N/A	0

Table 2-3 3D Audio Left/Right Balance

2.1.17 Cabin Speaker Selection and Volume

The **Cabin Speaker** key turns the cabin speaker on and off. The **Speaker Volume** key sets the volume level.



1. Touch the **Cabin Speaker** key to toggle the cabin speaker on and off.
2. Touch the **Speaker Volume** key to set the Cabin Speaker volume. Touch the **Speaker Volume** arrows to set the volume.

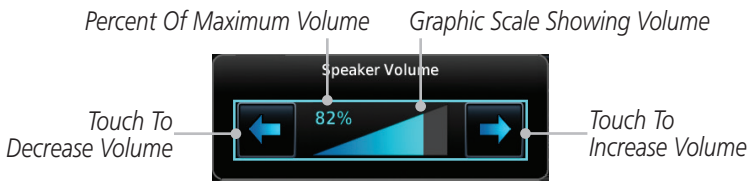

Figure 2-17 Cabin Speaker Volume Selection

2.1.18 Marker Audio and Volume

The optional Marker Beacon Receiver uses an audio indicator to alert you when the aircraft passes over a Marker Beacon transmitter. The audio from the Marker Beacon Receiver can be heard unless disabled by selecting Marker Audio. When Marker is selected (green bar shown), the tones for Marker Beacons are heard. When Marker is not selected (green bar not shown), the tones for Marker Beacons are not heard.

The GMA 35 marker beacon receiver and indicators are part of the ILS system. The marker beacon lamps operate independently of any audio selection and cannot be turned off. The GMA 35 can drive external marker lamps if required and also provides an autopilot middle marker sense output.

Prior to beginning an ILS approach, select high or low marker sensitivity with the **Marker Hi Sense** key. The lighted green bar in the key illuminates for high sensitivity and remains off for low sensitivity.

Touching the **Marker Audio** key prior to an approach allows the marker audio tones to be heard in the headsets. When the green bar in the **Marker Audio** key shows, the marker audio will be heard when available. The **Audio Panel** key will change to a **Mute** key. Touching the Mute key while audio is heard will mute the marker audio until the next beacon is received. The marker beacon signal sensitivity threshold can be set in Configuration mode. Contact a Garmin-authorized service center for adjustment.



1. While the Audio Control page is displayed, touch the **Marker Audio** key to hear the current Marker Beacon tones.
2. Touch the **Marker Audio** key again to disable Marker Beacon tones.
3. Touch the **Marker Volume** key to set the Marker Beacon tone volume. Touch the **Marker Volume** arrows to set the volume.



Percent Of Maximum Volume Graphic Scale Showing Volume

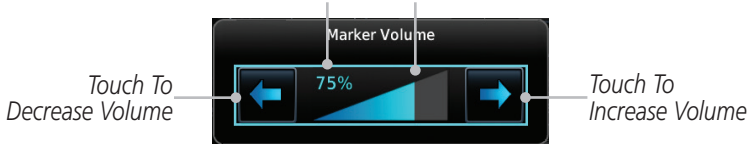

Figure 2-18 Audio Panel Marker Beacon Tone Volume Selection

Foreword
Getting Started
Audio & Xpdr Ctrl
Com/Nav
FPL
Direct-To
Proc
Charts
Wpt Info
Map
Traffic
Terrain
Weather
Nearest
Services/Music
Utilities
System
Messages
Symbols
Appendix

2.1.19 Marker Hi Sense

The Marker Hi Sense setting allows detecting the outer Marker Beacon from a greater distance.



1. While the Audio Control page is displayed, touch the **Marker Hi Sense** key to activate greater Marker Beacon sensitivity.
2. Touch the **Marker Hi Sense** key again to return to normal sensitivity.



2.1.20 Marker Beacon Annunciations

A visual annunciation of marker beacons will be shown on the display when the aircraft flies over a marker beacon. The annunciation will appear in the lower left of the display.

Current Beacon	Icon (Standard)	Icon (Blink)	Blink Interval
Inner Marker			250 ms
Middle Marker			333 ms
Outer Marker			750 ms

The marker beacon alternates between the standard icon and the blink icon at the blink interval corresponding to the current beacon.

Table 2-4 Marker Beacons

2.1.21 Audio Split Mode

In Split Mode the pilot uses one radio for MIC audio while the copilot uses a different radio. The pilot and copilot can transmit simultaneously over separate radios. The pilot can still listen to their individually selected radios. In the Split mode, the pilot and co-pilot may talk and listen independently to the radios (or PA) as selected.



Figure 2-19 Audio Panel Split Mode Controls

1. While the Audio Control page is displayed, touch the **Split Mode** key to display the Crew Intercom selections.
2. Touch the **Split Mode** key again to toggle the Crew Intercom selection off.
3. Touch the **Crew Intercom** key to toggle activation of the Crew Intercom allowing the Pilot and Co-Pilot to talk to each other.
4. Touch the desired Pilot and Co-Pilot Radio selections.

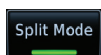
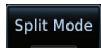

2.1.22 Playback Controls

The voice recorder feature records all the audio heard on any selected COM radio that is selected for transmission (the MIC selected COM) and not others selected for monitoring only. Playback is heard by anyone listening on the selected radios. The Clearance Recorder can record up to 2.5 minutes of Com audio.

Foreword
Getting Started
Audio & Xpdr Ctrl
Com/Nav
FPL
Direct-To
Proc
Charts
Wpt Info
Map
Traffic
Terrain
Weather
Nearest
Services/Music
Utilities
System
Messages
Symbols
Appendix

Playback Controls

- While the Audio Control page is displayed, touch the **Playback Controls** key to display the Playback Control selections.

Percent Of Maximum Volume Graphic Scale Showing Volume

Figure 2-20 Audio Panel Playback Controls



- Touch the **Playback Volume** arrows to set the volume.
- Touch the **Backward, Play, or Forward** keys to control the playback of the currently selected recording.
- Touch the **Previous** or **Next** keys to select a recording.
- Touch the **Back** key to return to the Audio Panel page.

2.2 Intercom Setup

The GTN 7XX can operate as a control head for remotely connected compatible intercom equipment. The Internal Communication System (ICS) has several modes of operation that are selected on the display of the GTN 7XX to control communication in the aircraft. Passengers cannot transmit over the active Com radio, even if equipped with a PTT key.

Depending on the installation and aircraft, the pilot and co-pilot positions on this page may be reversed (such as configured for rotorcraft).

1. Touch the **Intercom** window at the top of the display to display the Intercom Setup page.

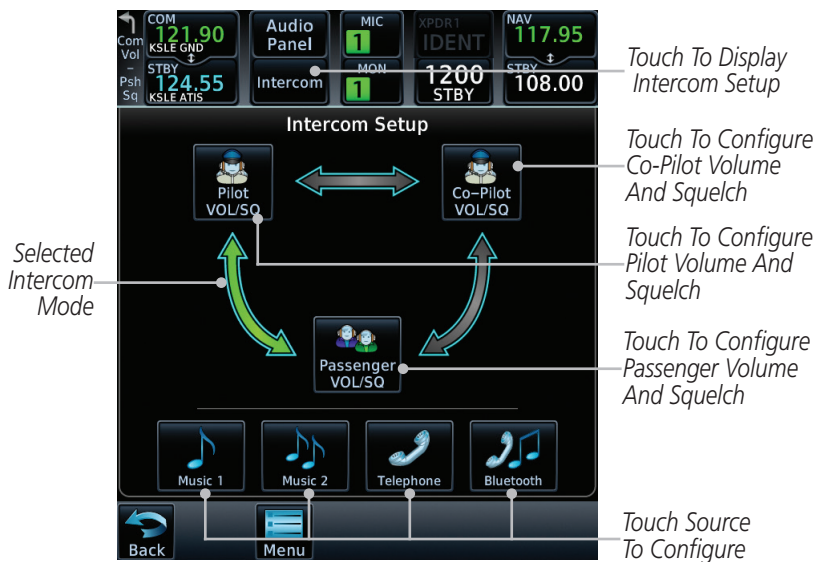

Figure 2-21 Intercom Setup

2. Touch the arrow between the intercom recipients to activate communication between those recipients. The arrow will be green when communication is active. Touch the arrow again to deactivate communication. Detailed information is shown in the Intercom Modes table.
3. Touch the key for a function to make the desired changes to their setup. Then, touch the **Back** key to return to the Intercom Setup page.









Mode	Pilot Hears	Co-Pilot Hears	Passengers Hear
	Selected radios, pilot	Selected radios, co-pilot	Passengers
	Selected radios, pilot, co-pilot	Selected radios, pilot, co-pilot	Passengers
	Selected radios, pilot, co-pilot	Selected radios, co-pilot, pilot, passengers	Selected radios, co-pilot, passengers
	Selected radios, pilot, passengers	Selected radios, co-pilot	Selected radios, pilot, passengers
	Selected radios, pilot	Selected radios, co-pilot, passengers	Selected radios, co-pilot, passengers
	Selected radios, pilot, co-pilot, passengers	Selected radios, pilot, co-pilot	Selected radios, pilot, passengers
	Selected radios, pilot, passengers	Selected radios, co-pilot, passengers	Selected radios, pilot, co-pilot, passengers
	Selected radios, pilot, co-pilot, passengers	Selected radios, pilot, co-pilot, passengers	Selected radios, pilot, co-pilot, passengers

Table 2-5 Intercom Modes

- Foreword
- Getting Started
- Audio & Xpdr Ctrl**
- Com/Nav
- FPL
- Direct-To
- Proc
- Charts
- Wpt Info
- Map
- Traffic
- Terrain
- Weather
- Nearest
- Services/ Music
- Utilities
- System
- Messages
- Symbols
- Appendix

Foreword
 Getting Started
Audio & Xpdr Ctrl
 Com/Nav
 FPL
 Direct-To
 Proc
 Charts
 Wpt Info
 Map
 Traffic
 Terrain
 Weather
 Nearest
 Services/
 Music
 Utilities
 System
 Messages
 Symbols
 Appendix

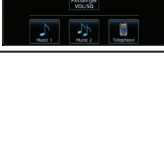
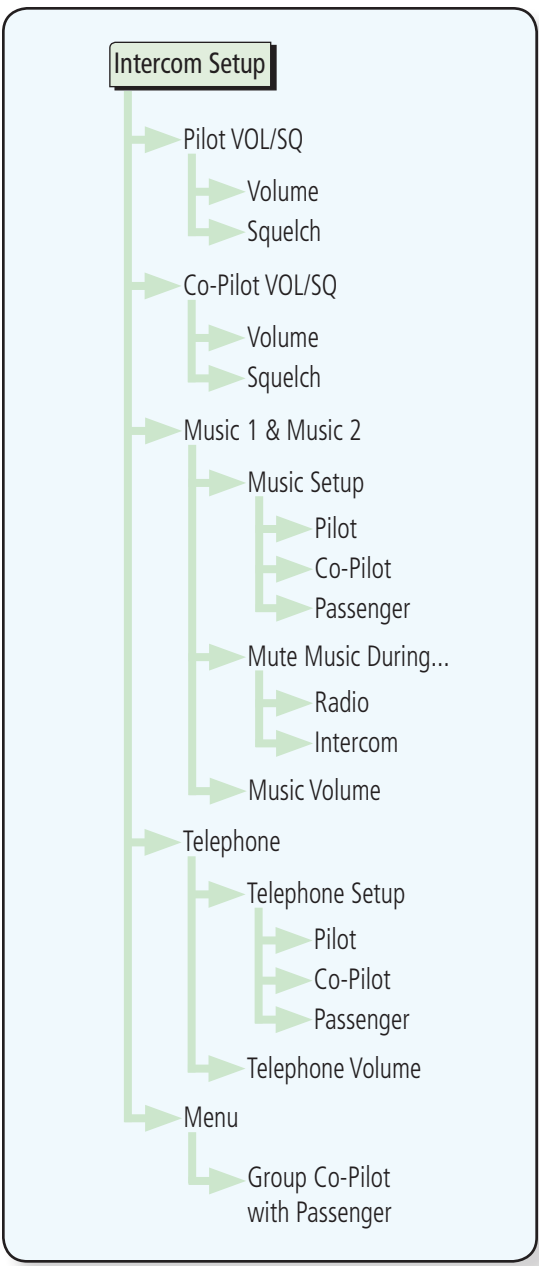

Figure 2-22 Intercom Setup Functional Diagram

2.1.23 Set Pilot, Co-Pilot, & Passenger Volume and Squelch

In the Intercom Setup function, the Volume and Squelch may be set separately for the Pilot, Copilot, and Passenger intercoms.



1. While viewing the Intercom Setup page, touch the **Pilot, Co-Pilot, or Passenger VOL/SQ** keys to set the Volume and Squelch for the selected item.

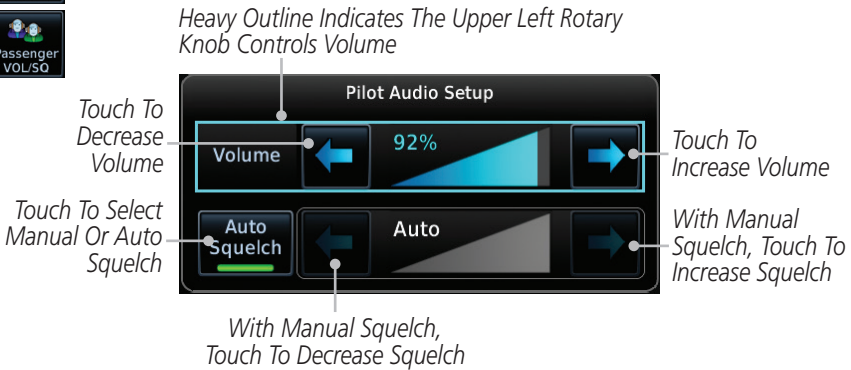

Figure 2-23 Pilot Audio Setup



2. Touch the **Volume** arrows to set the desired Volume level.
3. Touch the **Auto Squelch** key to allow the unit to set the Squelch level automatically. When enabled, the **Auto Squelch** key will display a green bar.
4. Touch the **Squelch** arrows to set the desired Squelch level.
5. Touch the **Back** key to return to the Intercom Setup page.

2.1.24 Co-Pilot is Passenger

When the GTN 7XX is installed with a GMA 35, the GTN can place the GMA into "Co-Pilot is Passenger" mode. While in this mode, the GMA 35 treats the copilot headset as a passenger headset and the co-pilot only hears what the other passengers hear. This applies to intercom audio, alerts (if configured for the passengers), selected audio (if configured for passengers), and music/telephone distribution. "Co-Pilot is Passenger" mode allows simpler audio control for the pilot when the co-pilot is just a passenger and not involved in flying the aircraft.

1. To activate "Co-Pilot is Passenger" mode, open the Intercom Setup page and touch **Intercom**.
2. Touch **Menu**, and then touch **Group Co-Pilot with Passenger** to enable "Co-Pilot is Passenger" mode.

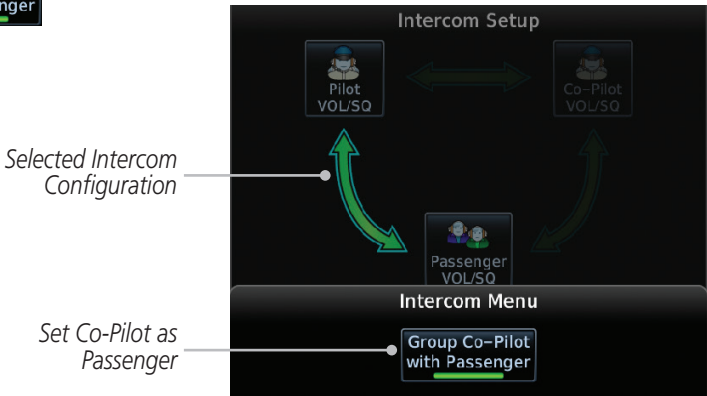

Figure 2-24 Set Co-Pilot as a Passenger in Intercom

NOTE: This feature should not be used for multi-crew aircraft. When the co-pilot is treated as a passenger, co-pilot position may not hear audio alerts or radios.

NOTE: While this mode is active, the co-pilot intercom and audio controls are unavailable because the co-pilot intercom/audio is controlled by the passenger controls. Split mode is also unavailable.



2.1.25 Music 1 and Music 2 Setup

The GMA 35 provides two music interfaces. Operation depends on the state of the music distribution.

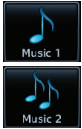

1. While viewing the Intercom Setup page, touch the **Music 1** or **Music 2** keys to set their setup.

Heavy Outline Indicates The Upper Left Rotary Knob Controls Volume

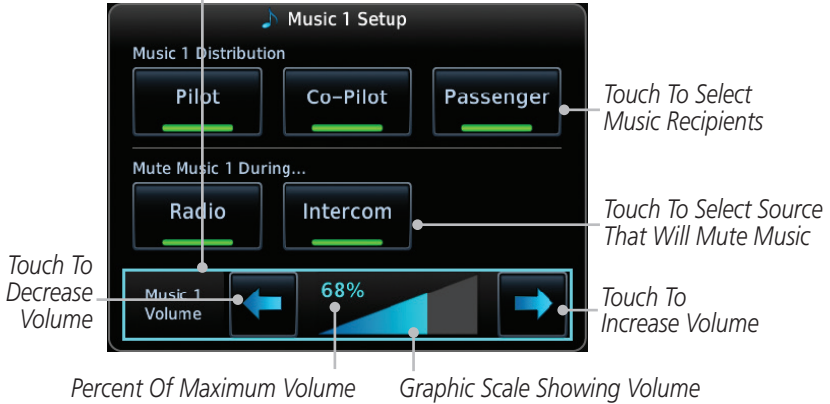
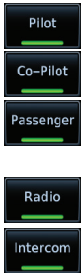

Figure 2-25 Music 1 Setup



2. Select the recipients for Music Distribution by touching any combination of the **Pilot**, **Co-Pilot**, or **Passenger** keys.
3. Touch the **Radio** and/or **Intercom** keys to select the function that, when active, Music will be muted.
4. Touch the **Volume** arrows to set the desired Volume level.



NOTE: At every power cycle, the "mute music during radio" selection will be active.

2.1.26 Telephone Setup

The GMA 35 provides a 2-way telephone interface. Operation depends on the state of the telephone distribution. Telephone communication is much like using the intercom, allowing both parties to talk at once.

NOTE: *Garmin recommends when using the GSR 56 Iridium phone system that the audio only be activated when on a phone call.*

The telephone channel may be disabled in Configuration mode. Contact a Garmin-authorized service center for details.

1. While viewing the Intercom Setup page, touch the **Telephone** key to set its setup.

Heavy Outline Indicates The Upper Left Rotary Knob Controls Volume

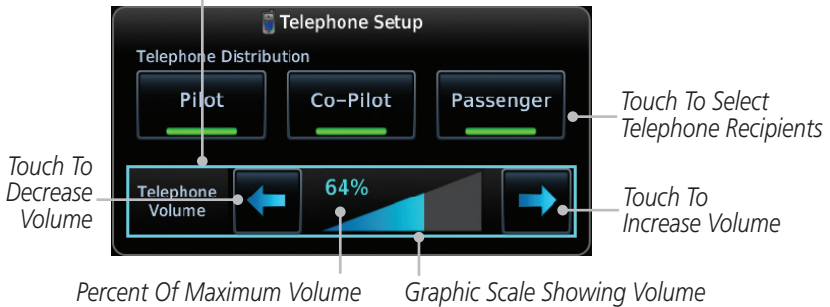

Figure 2-26 Telephone Setup

2. Select the recipients for Telephone Distribution by touching any combination of the **Pilot**, **Co-Pilot**, or **Passenger** keys.
3. Touch the **Volume** arrows to set the desired Telephone Volume level.

NOTE: *Telephone audio distribution is retained across power cycles for the passengers, however, pilot and co-pilot telephone distribution will default to OFF over power cycles.*



2.1.27 Bluetooth Setup

The GMA 35c provides a Bluetooth audio connection to a portable device. Operation depends on the state of the Bluetooth Audio Distribution.

1. While viewing the Intercom Setup page, touch the **Bluetooth** key to access its setup.

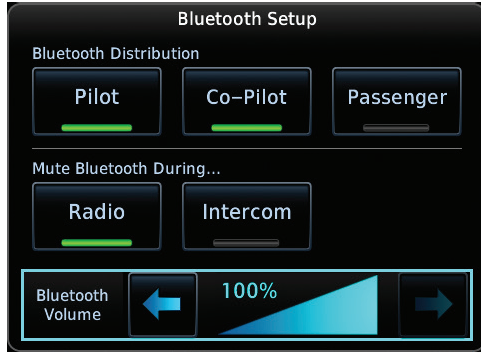
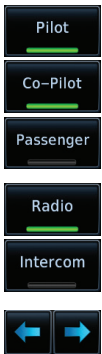

Figure 2-27 Audio Bluetooth Setup



2. Select the recipients for Bluetooth Distribution by touching any combination of the **Pilot**, **Co-Pilot**, or **Passenger** keys.
3. Touch the **Radio** and/or **Intercom** keys to select the function that, when active, will mute the Bluetooth audio.
4. Touch the **Volume** arrows to set the desired Volume level.



NOTE: At every power cycle, the “mute Bluetooth during radio” selection will be active.

2.3 Telligence™ Voice Command

Garmin's Telligence Voice Command voice recognition feature allows the pilot (and optionally copilot) to control the GTN 7XX connected to a GMA 35/350 using spoken commands. To activate Voice Recognition, push and hold the Push-to-Command (PTC) switch while speaking a command. When the Push-to-Command switch is released, the GTN 7XX and/or the audio panel will respond.

If a command is understood by the GMA, a positive acknowledgement chime will be played, and the relevant information will be displayed to reflect the change (if applicable). The pilot should verify that the correct response has occurred.

If a command is not understood by the GMA or the GTN is unable to complete the requested action, a negative acknowledgement tone will be played. The pilot should repeat the command by using the Push-to-Command switch, or by manually using the GTN 7XX touch screen. In the event of any abnormal Voice Recognition operation, the front panel controls and touch screen may be used to override Voice Recognition and manually control the GTN 7XX.



NOTE: *If Telligence Voice Command malfunctions and needs to be disabled, remove power to the GMA audio panel. This will force the audio panel into the fail-safe mode. The pilot will be able to communicate using the COM 2 radio only.*

The available voice recognition commands are listed in *GTN 6XX/7XX Telligence Voice Command Guide*, P/N 190-01007-50.

Foreword

Getting Started

Audio & Xpdr Ctrl

Com/Nav

FPL

Direct-To

Proc

Charts

Wpt Info

Map

Traffic

Terrain

Weather

Nearest

Services/
Music

Utilities

System

Messages

Symbols

Appendix

3 NAV/COM (GTN 750 NAV/COM)

The GTN 750 features a digitally-tuned VHF Com radio and digitally-tuned Nav/localizer and glideslope receivers. The GTN 750's Com radio operates in the aviation voice band, from 118.000 to 136.975 MHz, in 25 kHz steps (default). For European operations, a Com radio configuration of 8.33 kHz steps is also available.

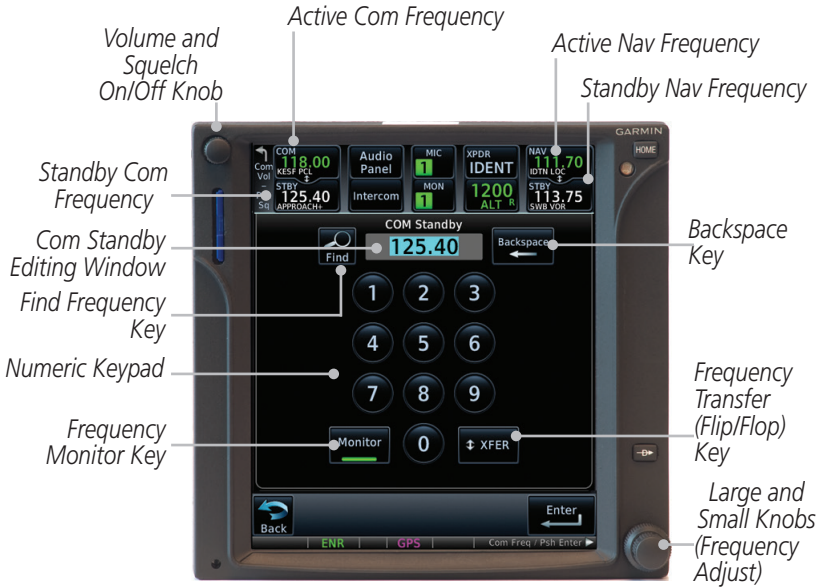

Figure 3-1 Nav/Com Controls

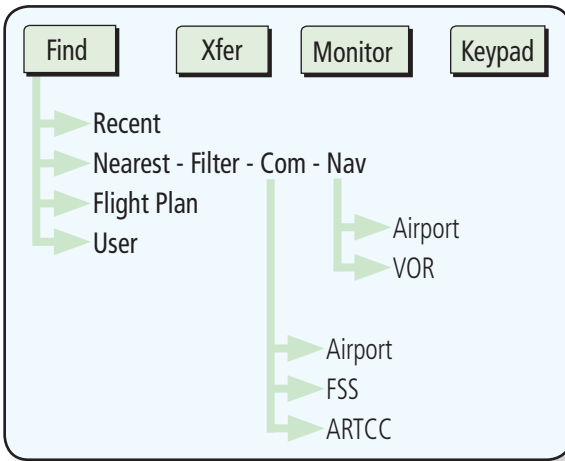

Figure 3-2 Nav/Com Functional Diagram

3.1 Volume

Com radio volume is adjusted using the **Volume** knob. Turn the **Volume** knob clockwise to increase volume, or counterclockwise to decrease volume. The level will be maintained until changed.

1. Turn the **Volume** knob to set the Com volume.



Percent Of Maximum Volume Graphic Scale Showing Volume

Figure 3-3 Com Volume Setting

2. A bar graph showing the relative volume level will indicate the selected level and will disappear a few seconds after releasing the **Volume** knob.

3.2 Squelch

The Com radio features an automatic squelch to reject many localized noise sources. You may override the squelch function by pressing the **Volume** knob. This facilitates listening to a distant station or setting the desired volume level.

To override the automatic squelch, press the **Volume** knob momentarily. Press the **Volume** knob again to return to automatic squelch operation. A “SQ” indication appears above the active Com frequency window in the upper left corner of the display when automatic squelch is overridden.

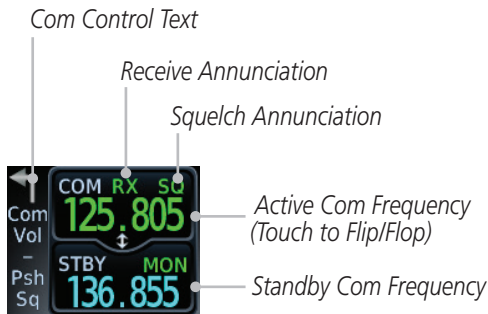

Figure 3-4 Com Controls

While receiving a transmission, an “RX” indication appears in the Com frequency window to the immediate right of “Com.” A “TX” indication appears at this location while you are transmitting.

3.3 Com Window and Tuning

Communication frequencies are selected by using the **large** and **small right** knobs or by touching the value in the *standby* Com frequency field and using the displayed keypad. The standby frequency always appears below the active frequency. The active frequency is the frequency currently in use for transmit and receive operations.

Once a frequency is selected in the standby field, it may be transferred to the active frequency by touching the active frequency field.



NOTE: *The Com window is normally active for adjustment, unless the NAV window is made active by pressing the **small right** knob. The active state automatically returns to the Com window after 30 seconds of inactivity.*

To select a Com frequency using the small and large right knobs:



1. If the tuning cursor is not currently in the Com window, press the **small right** knob momentarily. The Standby Com frequency will be highlighted to indicate that it is active for editing.
2. Turn the **large right** knob to select the desired megahertz (MHz) value. For example, the "118" portion of the frequency "118.30."
3. Turn the **small right** knob to select the desired kilohertz (kHz) value. For example, the ".30" portion of the frequency "118.30."

To select a Com frequency using the numeric keypad:

1. Touch the Standby window.
2. A pull down keypad will appear with the current Standby frequency highlighted.



Figure 3-5 Com Standby Frequency Numeric Keypad

3. Touch the numeric keys to add the desired values and touch **Enter** to accept the displayed value and place it into the Standby Com window.
4. Touching the **Xfer** key will place the selected frequency directly into the Active window.



To make the standby frequency the active frequency:

1. Touch the Com active frequency (top) window.
2. The Active (top) and Standby frequencies will flip/flop.



3.3.1 Com Frequency Finding

The GTN 750's frequency finding feature allows you to quickly select any displayed database Com frequency as your standby frequency. The following are some examples of selecting Com frequencies from some of the main GPS pages.

To select a Com frequency for a User created frequency, Recent selected frequency, Nearest airport, or from your Flight Plan:



1. While viewing the numeric keypad touch the **Find** key. Categories for User, Recent, Nearest, and Flight Plan are available.
2. Touch **Recent, Nearest, Flight Plan, or User**.



Selected Frequency Category

Selected Frequency for Nearest Airport

Touch to Select Nearest List

Figure 3-6 Com Nearest Airport Frequency

3. Touch the desired Com frequency to select it and place it into the Com Standby window.

3.3.1.1 Find Recent Frequencies

Recent

1. While viewing the **Find** results, touch the **Recent** tab. A list of the recently selected frequencies will be displayed.



Figure 3-7 Recent Com Frequency List

2. Touch the desired frequency to select it and place it into the Standby window.

3.3.1.2 Find Nearest Frequencies

Nearest

1. While viewing the **Find** results, touch the **Nearest** key. A list of the nearest airport Com frequencies will be displayed.



Figure 3-8 Com Nearest Airport Frequency

Multiple
FREQ

2. Touch the **Multiple FREQ** key to show the available frequencies.



*Touch A Frequency Key
To Place It In The Standby
Window*

Figure 3-9 Nearest Airport Multiple Frequency List

Filter

3. Touch the **Filter** key to filter the Nearest List by Airports, FSS, or ARTCC.

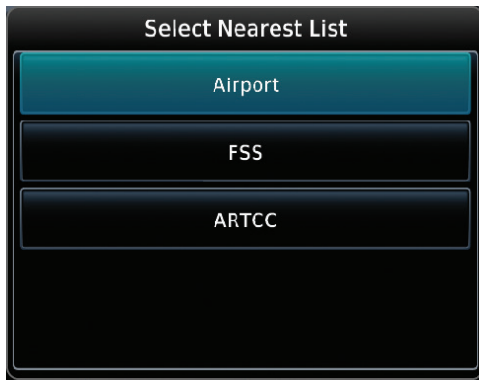

Figure 3-10 Nearest Com Frequency List

4. Touch the desired Frequency List. Then, touch the desired frequency to load it into the Standby window.

Foreword

Getting
Started

Audio &
Xpdr Ctrl

Com/Nav

FPL

Direct-To

Proc

Charts

Wpt Info

Map

Traffic

Terrain

Weather

Nearest

Services/
Music

Utilities

System

Messages

Symbols

Appendix

- Some frequencies will have more information detail available. Touch the key that shows "More Information."



Figure 3-11 More Information Is Available For Some Frequencies

- More detailed information is shown on the display. Touch the frequency to load it into the Standby window.



Figure 3-12 More Frequency Detail

Foreword

Getting Started

Audio & Xpdr Ctrl

Com/Nav

FPL

Direct-To

Proc

Charts

Wpt Info

Map

Traffic

Terrain

Weather

Nearest

Services/Music

Utilities

System

Messages

Symbols

Appendix

3.3.1.3 Find Flight Plan Frequencies

Flight Plan

1. While viewing the **Find** results, touch the **Flight Plan** tab. A list of Com or Nav frequencies associated with the active flight plan will be displayed.

Selected Frequency Category

Selected Frequency Category



Touch To Select Frequency From List For Nearest Airport

Figure 3-13 Flight Plan Frequency List

Multiple
FREQ

2. Touch the **Multiple FREQ** key to show the available frequencies, if present.
3. Touch the desired frequency to select it and place it into the Standby window.

3.3.1.4 Find User Frequencies

User

1. While viewing the **Find** results, touch the **User** tab. A list of User-created frequencies will be displayed.
2. Touch the desired frequency to load it into the Standby window.

3.3.2 Simple Frequency Entry

Frequencies can be entered on the GTN without the leading one and/or trailing zero(s). As a result, the pilot can touch “2,” “1,” and “5” for 121.50. If a number is pressed that is not valid for the cursor location, the pilot is presented with a confirmation pop-up upon selecting the typed frequency. Frequency entry can be accomplished by typing every digit in the frequency or by leaving off the leading one and/or trailing zero(s). The frequency that will be entered is always displayed in the cursor window.

1. Touch the Standby frequency field and then touch the **2** key.

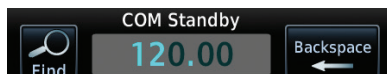

Figure 3-14 Simplified Frequency Entry Without Leading Number

2. Touch the **7** key.

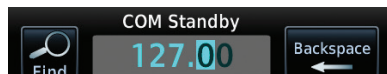

Figure 3-15 Second Frequency Number

3. Touch the **2** key.



Figure 3-16 Final Frequency Without Trailing Number

4. Touch **Enter**.



Figure 3-17 Completed Frequency Entry

3.3.3 Adding a New User Frequency



1. While viewing the numeric keypad touch the **Find** key at the bottom of the display.



2. Touch the **User** tab and then touch the **Add User Frequency** key.

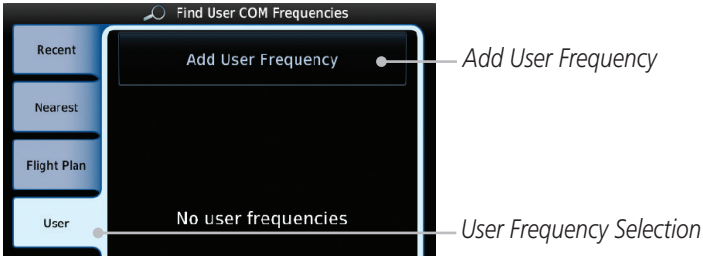
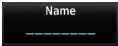

Figure 3-18 Add New User Frequency



3. The Add New User Frequency information window will now be displayed. Touch the **Name** key to select a name for the User frequency.

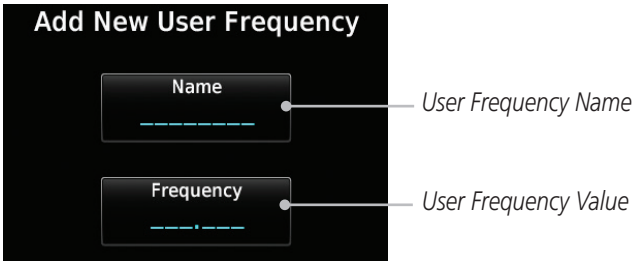

Figure 3-19 Add New User Frequency Detail Window

Foreword
Getting Started
Audio & Xpdr Ctrl
Com/Nav
FPL
Direct-To
Proc
Charts
Wpt Info
Map
Traffic
Terrain
Weather
Nearest
Services/Music
Utilities
System
Messages
Symbols
Appendix
Index



- Select the characters from the alphanumeric keypad for the desired name. Touch the **Enter** key to accept the displayed Name.

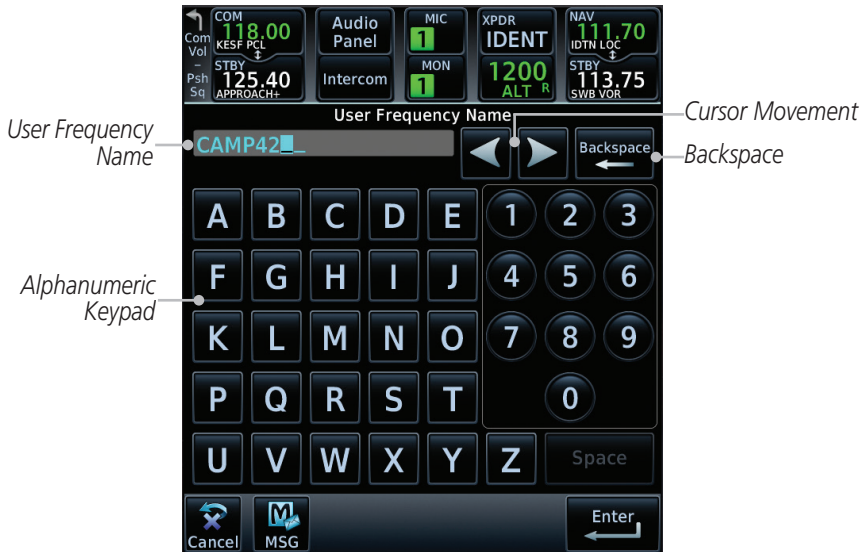
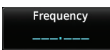

Figure 3-20 Select a Name for the New User Frequency



- Touch the **Frequency** key and select the characters from the keypad for the desired frequency. Touch the **Enter** key to accept the displayed frequency.



Figure 3-21 Select a Frequency Value for the New User Frequency



- Touch the **Enter** key to accept the displayed name and

frequency. The new User Frequency will be added to the list. The list can store up to 15 user frequencies.

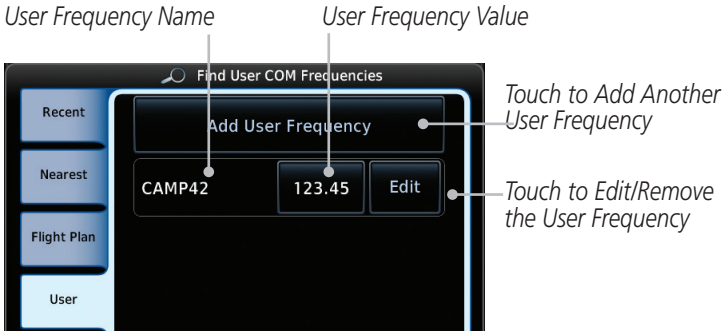

Figure 3-22 Completed New User Frequency

3.3.4 Emergency Frequency

The GTN 750's emergency frequency select provides a quick method of selecting 121.50 MHz as the active frequency in the event of an in-flight emergency. The emergency frequency select is available whenever the unit is on, regardless of GPS or cursor status, or loss of the display.



To quickly tune and activate 121.50, press and hold volume knob or the remote Com flip-flop key for approximately two seconds.



NOTE: Pressing and holding the remote Com FLIP/FLOP key for approximately two seconds, on units so configured, will lock the COM board, preventing further changes in Com frequency until the Com board is unlocked, by pressing the remote Com FLIP/FLOP key again for two seconds. The following message will notify the pilot that the Com board has been locked: "COM LOCKED TO 121.5 MHZ. HOLD REMOTE COM TRANSFER KEY TO EXIT."



NOTE: Under some circumstances if the Com system loses communication with the main system, the radio will automatically tune to 121.50 MHz for transmit and receive regardless of the displayed frequency.

3.3.5 Stuck Microphone

Whenever the GTN 750 is transmitting, a “TX” indication appears in the Com window. If the push-to-talk key on the microphone is stuck or accidentally left in the keyed position, or continues to transmit after the key is released, the Com transmitter automatically times out (or ceases to transmit) after 30 seconds of continuous broadcasting. You will also receive a “Com push-to-talk key stuck” message as long as the stuck condition exists.

3.3.6 Remote Frequency Selection Control

On units configured for remote Com frequency Recall, pressing the remote recall switch will load the next preset Com frequency into the unit’s Standby frequency box. The remote recall switch can be pressed multiple times to scroll the entire preset frequency list through the Standby frequency box (the list will “wrap” from the bottom of the list back up to the top, skipping any empty preset positions).

The standby frequency isn’t activated until a Com **FLIP/FLOP** switch (either bezel-mounted or remote (COM RMT XFR) is pressed. Remote Frequency Selection only functions on units configured for a remote Com Frequency recall switch.



NOTE: For software prior to v5.00, frequencies must be stored in the User Frequency List prior to utilizing the remote channel select switch.

3.3.7 Reverse Frequency Look-Up

When the Reverse Frequency Look-Up feature is enabled in System-Setup, the identifier and frequency type will be shown for the selected Com and Nav frequencies for the nearest stations that are in the aviation database when the unit is receiving a valid position input. Station Identifiers with a “+” sign will have more stations associated with this frequency than just the type displayed.

Identifier and Type Shown for the Selected Frequency

The “+” Sign Indicates More Stations Associated With This Frequency



Figure 3-23 Reverse Frequency Look-Up



NOTE: It can take up to 2 minutes for the RFL frequency to change after crossing the half way point when flying from one airport to another that both use the same frequency.

3.4 Com Frequency Monitoring

The Frequency Monitoring function allows you to listen to the Standby frequency in the Com radio, while monitoring the Active frequency for activity.



1. Touch the **Monitor** key to listen to the standby frequency. A small "MON" annunciation is displayed to the right of the Standby frequency. A green bar will show on the **Monitor** key. When the Active frequency receives a signal, the unit will switch automatically to the Active frequency and then switch back to the standby frequency when activity ceases.



Figure 3-24 Com Frequency Monitoring



2. The Monitor function is deactivated when you touch the **Monitor** key again and the green bar is extinguished.



NOTE: The Com radio Monitoring function is different than the Monitor function of the Audio Panel.

3.5 NAV (VOR/Localizer/Glideslope) Receiver Operations

The GTN 750 includes digitally-tuned Nav/localizer and glideslope receivers with the desired frequency selected on the *Nav window*, along the top right-hand side of the display. Frequency selection is performed by pressing the **small right** knob to activate Nav Standby frequency editing and then turning the **small** and **large right** knobs or keypad to select the desired frequency.

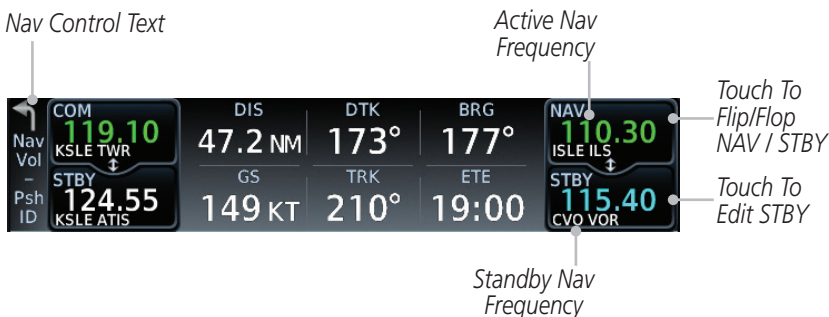

Figure 3-25 Nav Frequency Window

3.5.1 Ident Audio and Volume

Nav ident is enabled by pressing the **Volume** knob when the Nav window is active. When Nav ident is enabled, the ID annunciation will appear in the active Nav window and Morse code tones will be heard. When the Nav function is enabled, the Nav Standby channel window will highlight briefly and then turn to blue text. The Nav Standby frequency will be active for editing for about 30 seconds before the Com Standby frequency becomes active for editing.

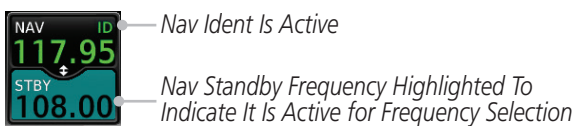

Figure 3-26 Nav Standby Frequency Window and Ident is Active

Nav audio volume is adjusted using the **Volume** knob. Turn the **Volume** knob clockwise to increase volume, or counterclockwise to decrease volume.

3.5.2 Nav Tuning Window

Nav frequencies are selected with the tuning cursor in the standby Nav frequency field, and using the small and large right knobs to dial in the desired frequency. The keypad may also be used for frequency entry after touching the Standby window. The standby frequency always appears below the active frequency. The active frequency is the frequency currently in use. The GTN will automatically decode Morse code and display the Ident for the active frequency above it. The RFL (reverse frequency lookup) Identifier is displayed below the frequency and is only dependent on GPS position and database information.



NOTE: *Tuning is normally active in the Com window, unless placed in the Nav window by pressing the **small right knob**. When the tuning cursor is in the Nav window, it automatically returns to the Com window after 30 seconds of inactivity. The active frequency in either window cannot be accessed directly — only the standby frequency is active for editing.*

To select a VOR/localizer/ILS frequency:



1. Touch the **small right** knob momentarily to make the Nav Standby frequency value active for editing. The window will be highlighted momentarily.
2. Turn the **large right** knob to select the desired megaHertz (MHz) value. For example, the "117" portion of the frequency "117.80."
3. Turn the **small right** knob to select the desired kiloHertz (kHz) value. For example, the ".80" portion of the frequency "117.80."
4. Touch the Nav active (top) frequency to make the standby frequency.
5. The Active (top) and Standby frequencies will switch.



Nav Frequencies In The Database Will Display The Ident Based on GPS Position



Nav Frequencies Will Automatically Decode Morse Code And Display The Ident

Figure 3-27 Automatic Nav Frequency Ident Decoding

3.5.3 Nav Frequency Finding

The GTN 750's frequency finding feature allows you to quickly select any displayed database Nav frequency as your standby frequency.

To select a Nav frequency for a User created frequency, Recent selected frequency, Nearest airport, or from your Flight Plan:

1. While viewing the numeric keypad touch the **Find** key at the bottom of the display. Categories for User, Recent, Nearest, and Flight Plan are available.
2. Touch the **User, Recent, Nearest, or Flight Plan** key.

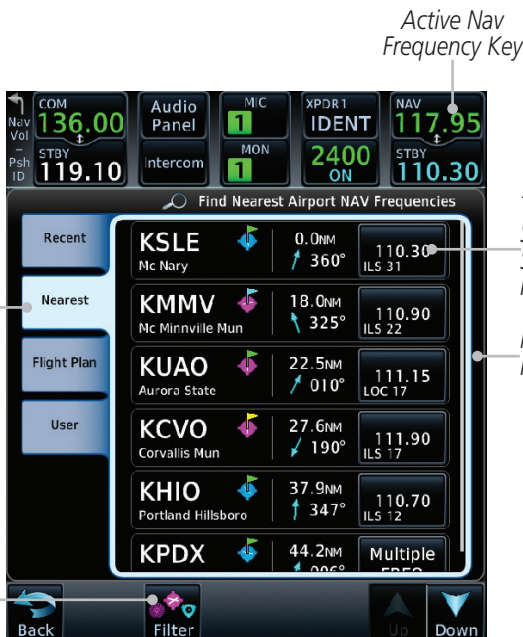

Figure 3-28 Nearest Airport Nav Frequency

Foreword
Getting Started
Audio & Xpdr Ctrl
Com/Nav
FPL
Direct-To
Proc
Charts
Wpt Info
Map
Traffic
Terrain
Weather
Nearest
Services/Music
Utilities
System
Messages
Symbols
Appendix

3. Touch the desired Nav frequency to select it and place it into the Nav Standby window.

OR



4. Touch the **Filter** key to narrow the list by category, such as Airport and VOR, and then select a given frequency.

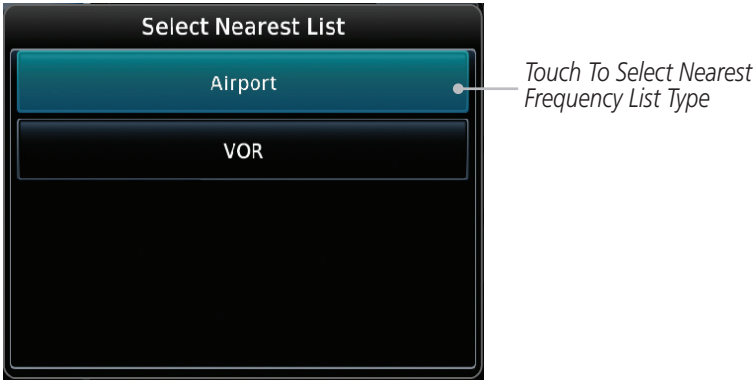

Figure 3-29 Nearest Nav Frequency List

Foreword

Getting
Started

Audio &
Xpdr Ctrl

Com/Nav

FPL

Direct-To

Proc

Charts

Wpt Info

Map

This page intentionally left blank

Traffic

Terrain

Weather

Nearest

Services/
Music

Utilities

System

Messages

Symbols

Appendix

4 FLIGHT PLANS

The GTN 7XX lets you create up to 99 different flight plans, with up to 100 waypoints in each flight plan. The Flight Plan function is accessed by touching the **Flight Plan** key on the Home page. The Flight Plan function allows you to create, store, edit, and copy flight plans.

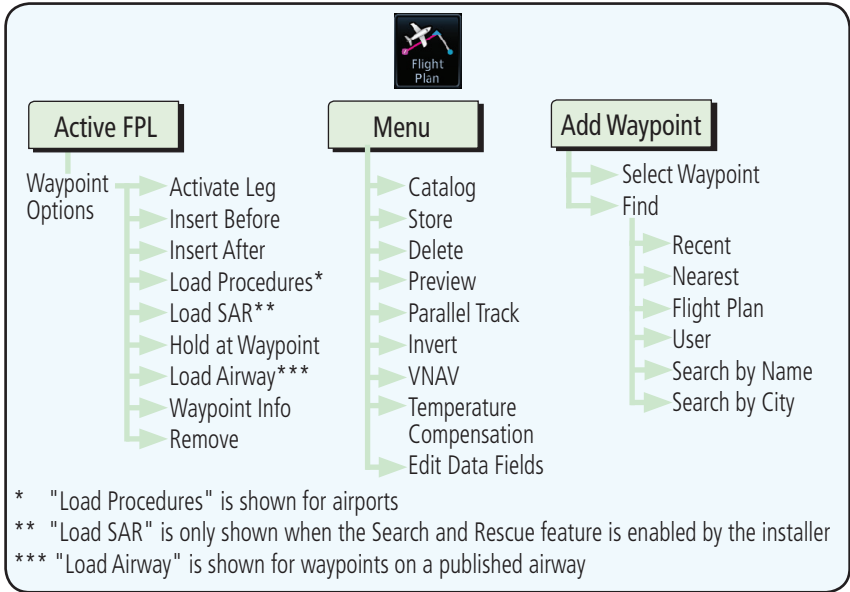

Figure 4-1 Flight Plan Functional Diagram



NOTE: Navigation is provided for fixed wing aircraft above 30 kts and for rotorcraft above 10 kts.



NOTE: The Chart feature provides a digital representation of a paper chart and provides no vertical or lateral course guidance. Flight Plan and Procedures are separate from Charts, and do provide vertical and lateral course guidance for the loaded route or procedure shown on the Flight Plan page. The term "Chart Unavailable" means that the chart cannot be viewed on the Charts due to either a chart not being published, or an error in the Chart database, but does not preclude its availability or inclusion of the procedure in the Flight Plan or Procedures portion of the system. The absence of a chart for a particular Departure, Arrival, or Approach does not preclude its availability or inclusion in the Flight Plan or Procedures portion of the system. The absence of a particular Departure, Arrival, or Approach under the Flight Plan or Procedures portion of the system does not preclude the ability to view the Chart for that procedure under the Chart feature.

4.1 Creating a New Flight Plan

4.1.1 Creating a New Flight Plan in the Catalog

1. From the Home page, touch **Flight Plan**.
2. Touch **Menu** and then the **Catalog** key.
3. Touch the **Create New Catalog Route** key at the end of the flight plan list in the Catalog.



Create New Catalog Route



Touch To Create
New Flight Plan

Figure 4-2 Create a New Catalog Route (Flight Plan)

4. Touch the **Add Waypoint** key and select a waypoint identifier with the alphanumeric keypad. Then, touch **Enter**.

Add Waypoint



Selected Flight
Plan Waypoint



Figure 4-3 Select a Waypoint for the New Flight Plan



NOTE: If a flight plan that includes a procedure that has been modified by the pilot is saved into the flight plan catalog, the GTN cannot check the accuracy of that procedure when that flight plan is used on a later flight. It is recommended that flight plans with modified procedures not be saved in the flight plan catalog.

4.1.2 Creating a New Flight Plan from the Active Flight Plan

1. From the Home page, touch **Flight Plan**.

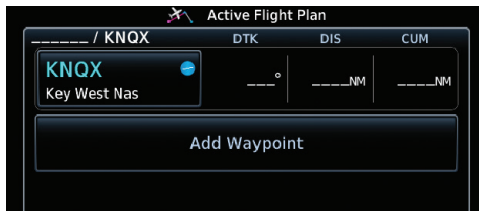
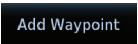

Figure 4-4 Create New Flight Plan by Clearing Active Flight Plan

2. If there is already an Active Flight Plan, touch **Menu** and then the **Delete** and **OK** keys to delete the existing active flight plan. The stored flight plan in the Catalog will not be deleted.
3. Touch the **Add Waypoint** key and select a waypoint identifier with the alphanumeric keypad. Then, touch **Enter**.
4. Touch the **Add Waypoint** key and select the waypoint identifier with the keypad for the next waypoint. Touch **Enter**.
5. Continue adding waypoints as needed.
6. Touch **Menu** and then touch **Store** to store the flight plan in the Catalog. The screen will now display the Flight Plan Catalog and show the new flight plan. Flight plans are listed by the Departure and Destination waypoints.



4.2 Active Flight Plan Page

The Active Flight Plan Page provides information and editing functions for the flight plan currently in use for navigation. Once you have activated a flight plan, the Active Flight Plan Page shows each waypoint for the flight plan, along with the Desired Track (DTK), Distance (DIST) for each leg and Cumulative Distance (CUM). The data fields are user-selectable and may be changed to display Cumulative Distance (CUM), Distance (DIST), Desired Track (DTK), En Route Safe Altitude (ESA), or Estimated Time of Arrival (ETA).

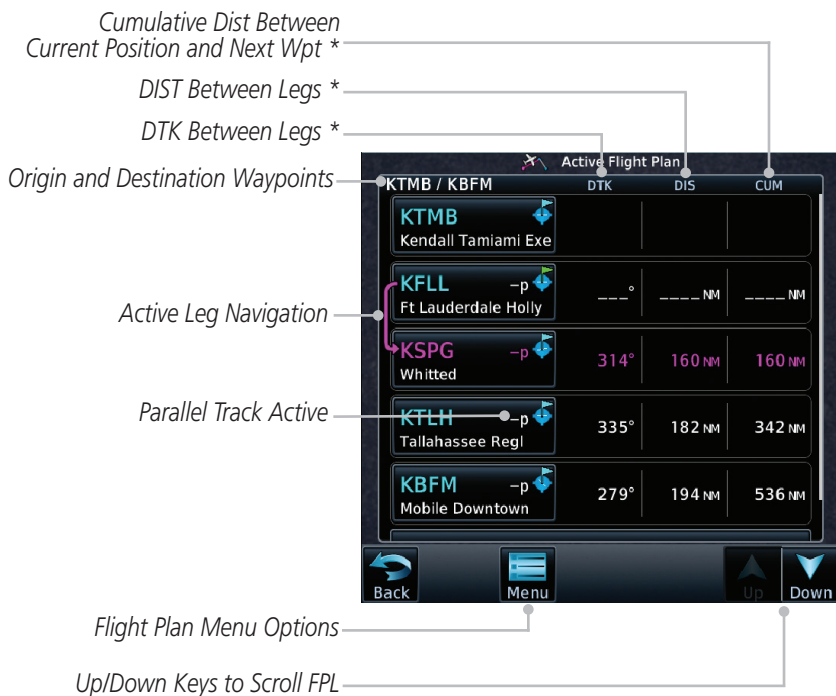

Figure 4-5 Active Flight Plan Page

* The field types may be changed using the Edit Data Fields function in the Flight Plan page Menu.

4.2.1 Waypoint Options

KMHT
Manchester

1. While viewing the Active Flight Plan page, touch the desired flight plan waypoint. The Waypoint Options window menu opens.

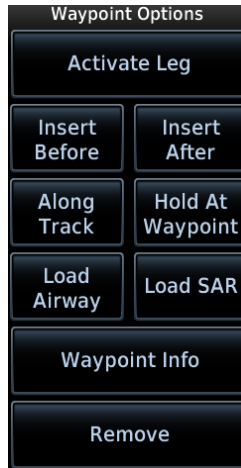

Figure 4-6 Active Flight Plan Wpt Options with SAR Available

2. Touch one of the options to perform the selected action. Cancel the option selection by touching the **Back** key.

Foreword

Getting Started

Audio & Xpdr Ctrl

Com/Nav

FPL

Direct-To

Proc

Charts

Wpt Info

Map

Traffic

Terrain

Weather

Nearest

Services/
Music

Utilities

System

Messages

Symbols

Appendix

4.2.1.1 Activate Leg

The Activate Leg option allows you to change the active leg of a flight plan.

Activate Leg

1. On the Waypoint Options menu, touch the desired TO waypoint and then the **Activate Leg** key to select the TO waypoint as the active leg for navigation.

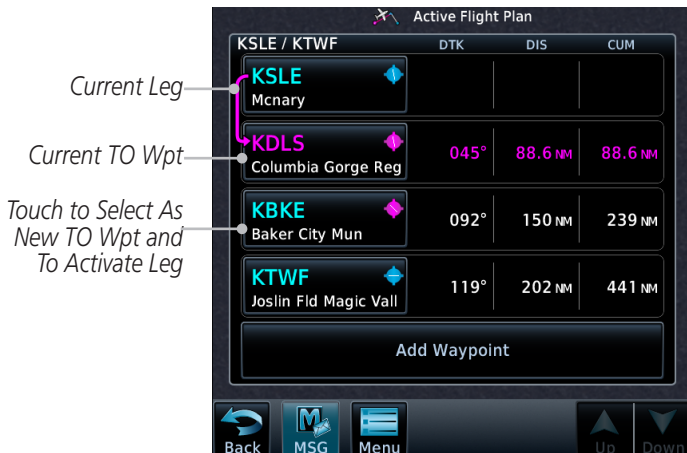

Figure 4-7 Active Flight Plan Activate Leg Option

OK

2. Touch the **OK** key to set the selected leg as the Active Leg, or **Cancel** to not select it.

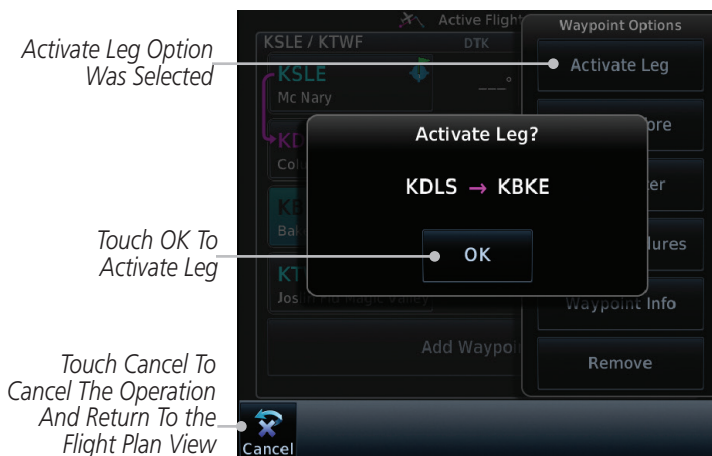

Figure 4-8 Active Flight Plan Activate Leg Option

4.2.1.2 Insert Before

The Insert Before option allows you to insert a new waypoint into the active flight plan before the selected waypoint.

KBTV
Burlington Intl

1. On the Active Flight Plan page, touch the desired waypoint in the flight plan. The Waypoint Options list will be displayed.



Figure 4-9 Active Flight Plan Insert Waypoint Before Option

Insert Before

2. Touch the **Insert Before** key to select a new waypoint before the selected waypoint.
3. Select a waypoint identifier with the alphanumeric keypad.

Choose New Waypoint To Insert Before Selected Flight Plan Waypoint



Figure 4-10 Use the Alphanumeric Keypad to Select Waypoint to Insert Before

Foreword



- Then, touch **Enter** to confirm the selection, or touch **Cancel** to cancel any changes. The new flight plan will be shown.

Getting Started

Audio & Xpdr Ctrl

Com/Nav

FPL

Direct-To

Proc

Charts

Wpt Info

Map

Traffic

Terrain

Weather

Nearest

Services/
Music

Utilities

System

Messages

Symbols

Appendix

New Waypoint Inserted Before Selected Flight Plan Waypoint



Figure 4-11 New Waypoint Is Inserted Before the Selected Waypoint

Map

Traffic

Terrain

Weather

Nearest

Services/
Music

Utilities

System

Messages

Symbols

Appendix



Figure 4-12 Flight Plan Before and After New Waypoint Inserted

4.2.1.3 Insert After

The Insert After option allows you to insert a new waypoint into the active flight plan after the selected waypoint.

1. On the Active Flight Plan page, touch the desired waypoint in the flight plan. The Waypoint Options list will be displayed.
2. Touch the **Insert After** key to select a new waypoint after the selected waypoint.
3. Select a waypoint identifier with the alphanumeric keypad. Then, touch **Enter** to confirm the selection, or touch the **Cancel** key to cancel the operation and return to the Waypoint Options window.



4.2.1.4 Along Track Offsets



NOTE: This feature is available in software v6.50 and later.

An along track (ATK) represents a temporary lateral position (or checkpoint) relative to an existing waypoint in the flight plan. Offset distance values range between 1 nm and 200 nm, and may be specified in 1 nm increments.

Unlike database waypoints, ATKs indicate a temporary route fix in the flight plan. Once created, their position remains fixed until deleted by the pilot. Subsequent changes to the flight plan do not update the ATK's position.

ATKs appear in flight plan route depictions on the Active Flight Plan and Map pages.

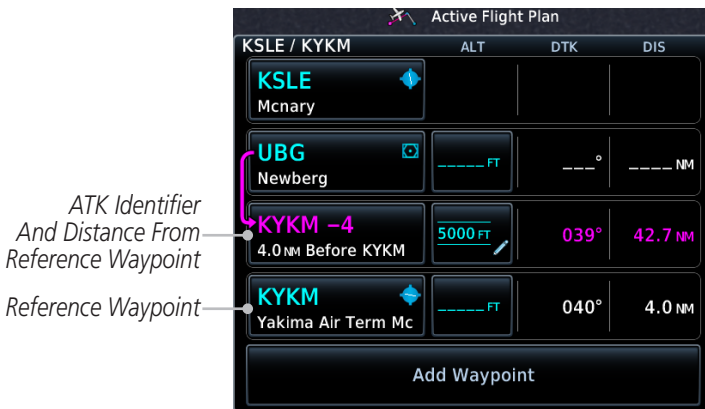

Figure 4-13 ATK Inserted Before Reference Waypoint

Inserting the ATK before the selected waypoint results in a negative offset value. Inserting it after the selected waypoint results in a positive value. The flight plan allows multiple entries.

- Foreword
- Getting Started
- Audio & Xpdr Ctrl
- Com/Nav
- FPL**
- Direct-To
- Proc
- Charts
- Wpt Info
- Map
- Traffic
- Terrain
- Weather
- Nearest
- Services/Music
- Utilities
- System
- Messages
- Symbols
- Appendix

Selecting Before Automatically Assigns A Negative Value



Figure 4-14 Along Track Offset Keypad

Once entered, offset distances are not editable. If the offset requires adjustment, delete the existing ATK from the flight plan, and then create a new ATK with the correct offset distance.



Map indications include a dedicated icon and an identifier label. The identifier label denotes the adjacent waypoint's ID and offset distance from the specified ATK.



Figure 4-15 ATK Indications on Map Page

To create an ATK:



1. While viewing the Active Flight Plan page, select a waypoint. The Waypoint Options menu opens.
2. Touch the **Along Track** key.
3. Specify an offset distance using the controls on the keypad.
4. Select **Before** or **After** to place the ATK before or after the reference waypoint.
5. Touch **Enter**.

To create an ATK for an altitude constraint:



1. While viewing the Active Flight Plan page, select an altitude constraint. The VNAV Options menu opens.
2. Touch the **Along Track** key.
3. Specify an offset distance using the controls on the keypad.
4. Select **Before** or **After** to place the ATK before or after the reference waypoint.
5. Touch **Enter** and then **Save**.

4.2.1.5 Remove

The Remove option allows you to remove the selected waypoint from the active flight plan.

1. On the Active Flight Plan page, touch the desired waypoint in the flight plan. The Waypoint Options menu opens.
2. Touch **Remove** and then **OK**.

Delete

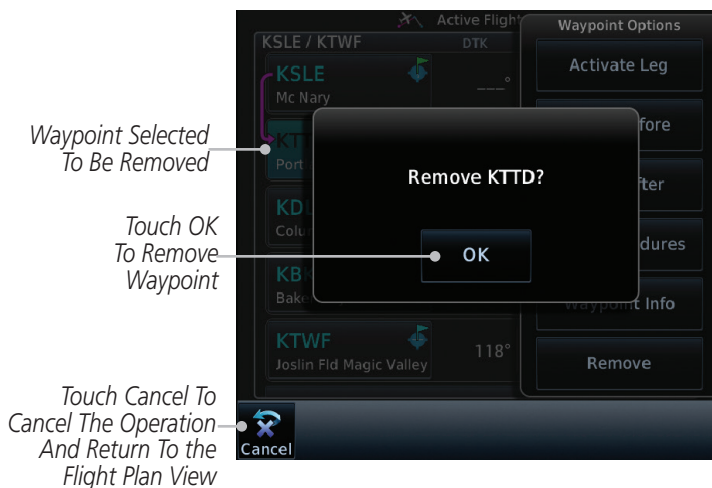

Figure 4-16 Active Flight Plan Remove Waypoint Option

4.2.1.6 Load Procedures

The Load Procedure selection from the Waypoint Options will start the Procedures function. See the Procedures section for complete information.

1. On the Active Flight Plan page, touch the desired waypoint in the flight plan. The Waypoint Options menu opens.
2. Touch the **Load Procedures** key to go to the Procedure function for adding procedures to the selected flight plan.

Load Procedures

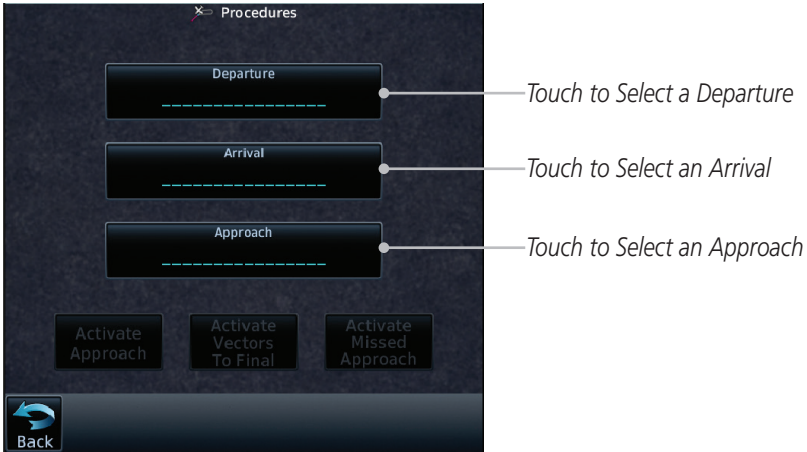

Figure 4-17 Load Procedures Wpt Option



NOTE: In software v5.13 and earlier, for some procedures, due to very small position differences in the database, consecutive flight plan legs do not match up. The total effect on navigational guidance is negligible. The LOC BC 13 at KSLE via UBG shown below is an example of this.

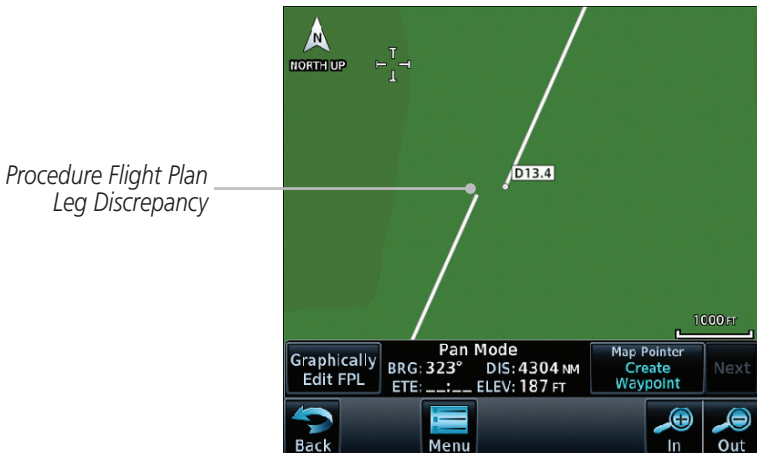

Figure 4-18 Procedure Flight Plan Leg Position Difference

4.2.1.7 Waypoint Info

The Waypoint Info option allows you to view information about the selected waypoint. See the Waypoint Info section for complete information.

1. On the Active Flight Plan page, touch the desired waypoint in the flight plan. The Waypoint Options menu opens.
2. Touch the **Waypoint Info** key to view information about the selected waypoint.

Waypoint Info

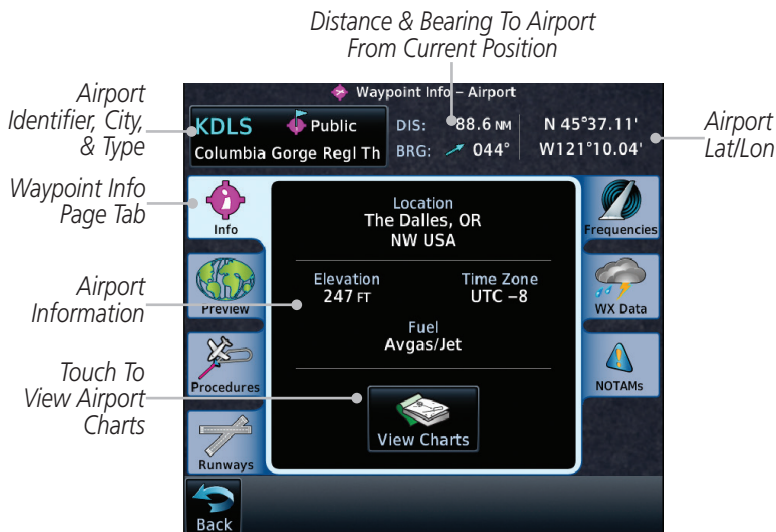

Figure 4-19 Active Flight Plan Wpt Info

3. Touch the **Back** key to return to the Active Flight Plan page.



4.2.2 Airways

Airways may be added as legs in flight plans with any waypoint that is part of an airway, such as a VOR.

1. On the Active Flight Plan page, touch the desired airway entry waypoint in the flight plan. The Waypoint Options menu opens.

Touch VOR Entry Wpt To Insert Airway



Figure 4-20 Active Flight Plan with VOR Entry Wpt

Load Airway

2. Touch the **Load Airway** key to select an airway for the selected entry waypoint.



Touch To Insert Airway

Figure 4-21 Select Load Airway from the Waypoint Options

3. Touch the desired airway to select it.



Figure 4-22 Select an Airway from the List

4. Scroll through the list and touch the desired exit point from the airway. The Airway list can be sorted by distance or alphabetically. Touch the **Sort Alpha** key to toggle the sort setting.



Figure 4-23 Select an Exit Waypoint for the Airway

Load

- Confirm the airway information and then touch **Load** to insert the selected airway into the flight plan. Use the **In** and **Out** keys, and drag the map with your finger to view the airway detail. If changes are desired, touch the **Airway** or **Exit Waypoint** keys to select alternate choices.

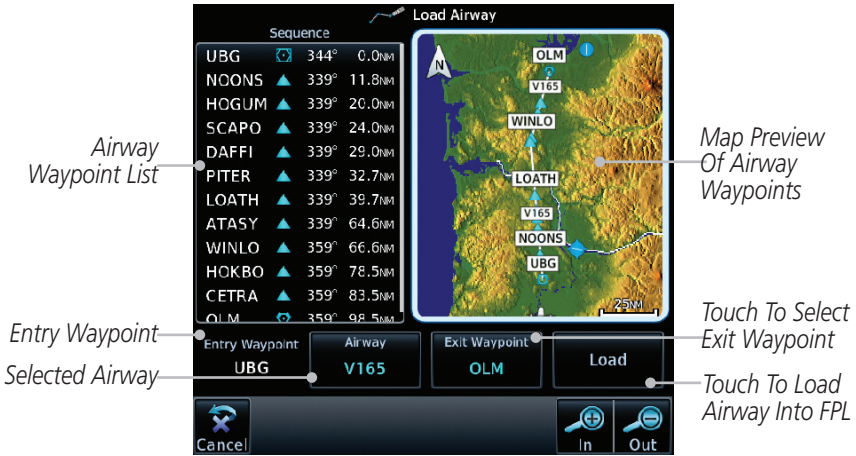

Figure 4-24 Airway Information

- After loading the airway, it is inserted into the flight plan. The airway waypoints are shown below the **Airway** key on the display. Touch the airway to make any changes.

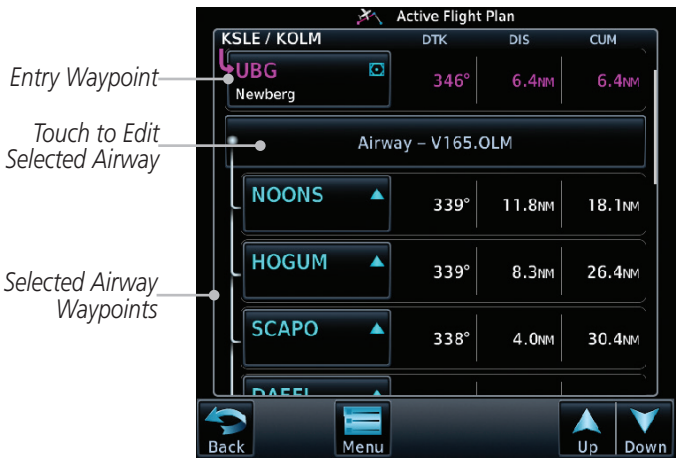

Figure 4-25 Airway Waypoints in the Flight Plan

Foreword
Getting Started
Audio & Xpdr Ctrl
Com/Nav
FPL
Direct-To
Proc
Charts
Wpt Info
Map
Traffic
Terrain
Weather
Nearest
Services/Music
Utilities
System
Messages
Symbols
Appendix

7. Touch the **Airway** key to display the Airway Options. Make the desired choice or touch **Back**.

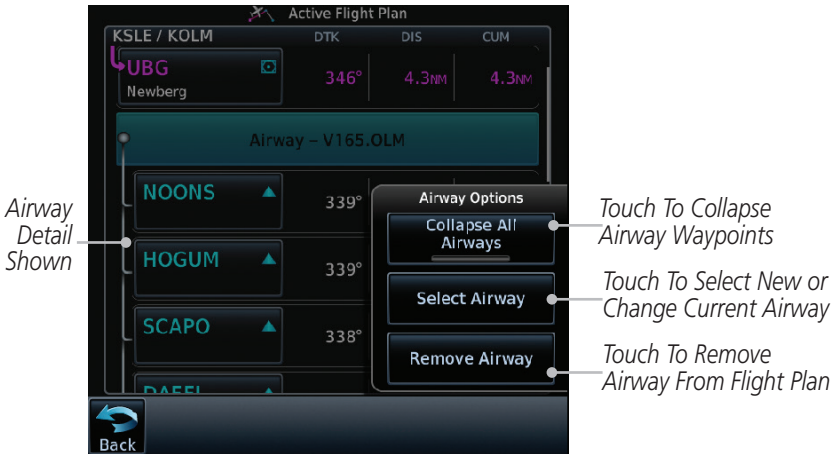

Figure 4-26 Airway Options

8. Touch the **Collapse All Airways** key to collapse the list of points along the airway. Touch the **Collapse All Airways** key again to toggle the display of airway detail back on.

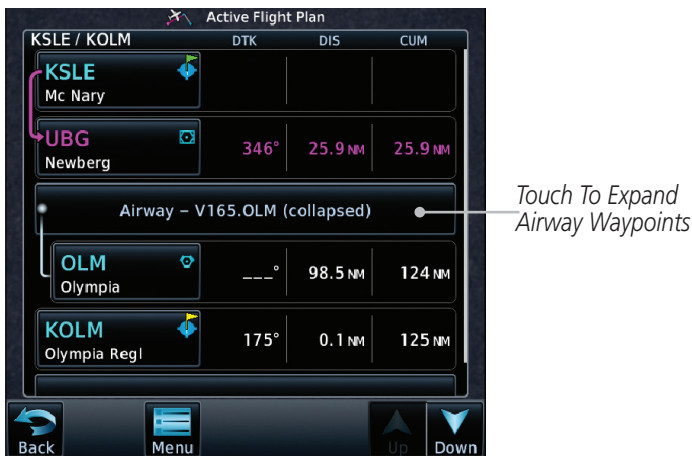

Figure 4-27 Airways Collapsed In Flight Plan

Foreword
Getting Started
Audio & Xpdr Ctrl
Com/Nav
FPL
Direct-To
Proc
Charts
Wpt Info
Map
Traffic
Terrain
Weather
Nearest
Services/
Music
Utilities
System
Messages
Symbols
Appendix

4.2.3 Load Hold at Waypoint



NOTE: This feature is available in software v6.00 and later.

4.2.3.1 Hold at Waypoint

Holding patterns may be added to existing waypoints within the flight plan.

1. On the Active Flight Plan page, touch the desired waypoint in the flight plan. The Waypoint Options menu opens.



Figure 4-28 Active Flight Plan with Hold At Waypoint Option

2. Touch the **Hold At Waypoint** key to open the Hold at Waypoint dialog window.

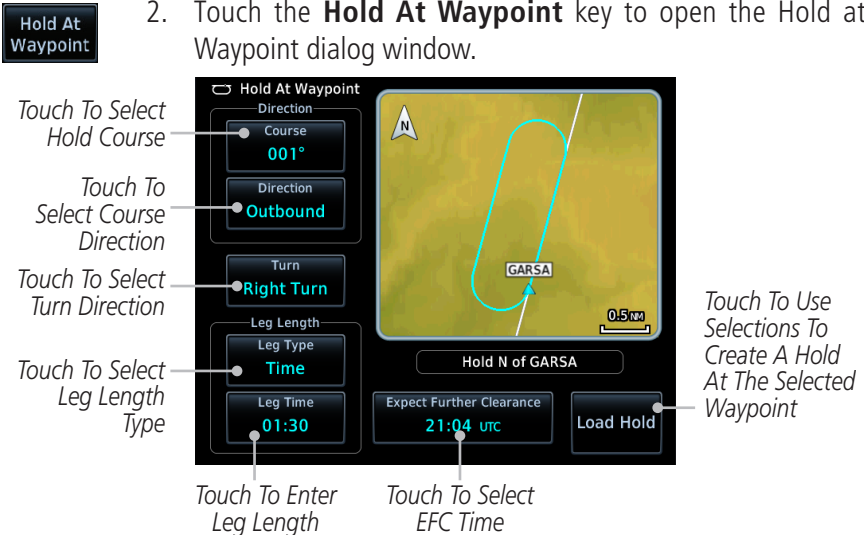
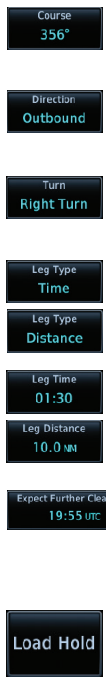

Figure 4-29 Creating a User-Defined Hold

- Foreword
- Getting Started
- Audio & Xpdr Ctrl
- Com/Nav
- FPL
- Direct-To
- Proc
- Charts
- Wpt Info
- Map
- Traffic
- Terrain
- Weather
- Nearest
- Services/Music
- Utilities
- System
- Messages
- Symbols
- Appendix



3. Touch the **Course** key to open the keypad. Use the keypad and **Enter** to select the inbound or outbound course.
4. Touch the **Direction** key to select between Inbound or Outbound for the course direction.
5. Touch the **Turn** key to select between Left or Right for the turn direction.
6. Touch the **Leg Type** key to select between Time or Distance for the leg type.
7. Touch the **Leg Time** or **Leg Distance** key to display the keypad. Use the keypad and the **Enter** key to select the length of the leg.
8. Touch the **Expect Further Clearance** key to display the keypad. Use the keypad and the **Enter** key to select the time for a reminder.
9. Touch the **Load Hold** key to add the hold into the flight plan.

4.2.3.2 Removing a Hold

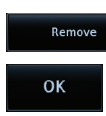

1. On the Active Flight Plan page, touch the hold to be removed. The Hold Options window is displayed.
2. Touch the **Remove** key.
3. Touch the **OK** key in response to "Remove Holding Pattern?" The holding pattern is removed. To cancel the request, touch the **Cancel** key.

4.2.4 Load Search and Rescue Patterns (Optional)



NOTE: This feature is available in software v6.00 and later.



NOTE: Turn smoothing may result in SAR coverage being different than intended. The flight crew should always verify that the SAR pattern created conforms to the specific mission requirements.

Search and Rescue Patterns may be added to existing waypoints within the active flight plan. Only one SAR pattern can exist in the active flight plan. Loading another SAR pattern into the active flight plan when one already exists will remove the first SAR pattern.

Each pattern has a default initial track. When the pilot changes the initial track on a SAR pattern, that change becomes the default initial track the next time the SAR pattern is accessed within the GTN. The pilot can always change the initial track when creating a SAR pattern in the flight plan.



NOTE: Flight plans cannot be stored in the catalog if they contain a SAR pattern.

1. On the Active Flight Plan page, touch the desired waypoint in the flight plan. The Waypoint Options menu opens.



Figure 4-30 Active Flight Plan with Load SAR Option



2. Touch the **Load SAR** key to open the Search and Rescue Patterns page.

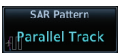

3. Touch the **SAR Pattern** key to select between Parallel Track, Sector Search, Expanding Square, or Orbit for the SAR pattern type. The available patterns can be configured by the installer and all of the listed pattern types may not be available.

Foreword
Getting Started
Audio & Xpdr Ctrl
Com/Nav
FPL
Direct-To
Proc
Charts
Wpt Info
Map
Traffic
Terrain
Weather
Nearest
Services/Music
Utilities
System
Messages
Symbols
Appendix

- Load Pattern
- Load Pattern & Activate

4. Confirm the SAR pattern information and then touch the **Load Pattern** key to load selected pattern to the active flight plan or touch the **Load Pattern & Activate** key to load selected pattern to the active flight plan and go direct-to the initial waypoint.
5. The SAR pattern waypoints are shown below the **SAR** key on the display. Touch the SAR pattern to make any changes.



Figure 4-31 SAR Pattern Waypoints in the Flight Plan

6. Touch the **SAR** key to display the Search & Rescue Options. Make the desired choice or touch the **Back** key.

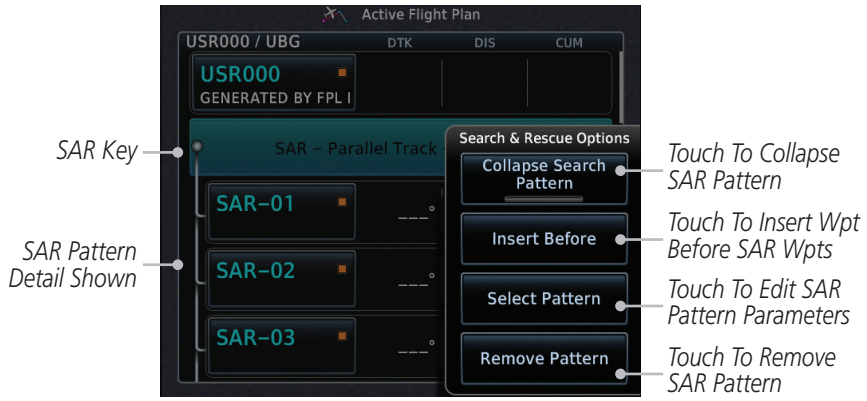

Figure 4-32 Search & Rescue Options

Collapse Search Pattern

7. Touch the **Collapse Search Pattern** key to collapse the list of the points along the SAR pattern. Touch the **Collapse Search Pattern** key again to toggle the display of SAR pattern detail back on.

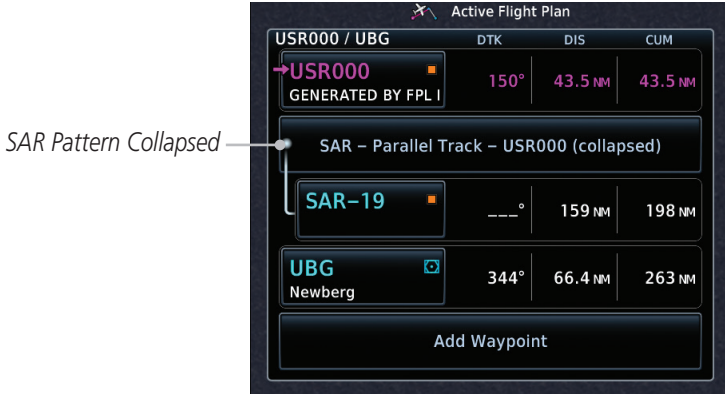

Figure 4-33 SAR Pattern Collapsed in Flight Plan

4.2.4.1 Creating a Parallel Track Pattern

The Parallel Track SAR pattern starts at the initial waypoint and follows the initial track for the length of the first parallel track leg. A 90° turn in the initial turn direction leads to the spacing leg with a length equal to the track spacing. Another 90° turn leads to the second parallel track leg. The turns at the end of the second parallel track leg are in the opposite direction as the previous parallel track leg. The parallel track pattern terminates once the desired number of parallel track legs have been flown. The default initial track for the Parallel Track Pattern is True North.

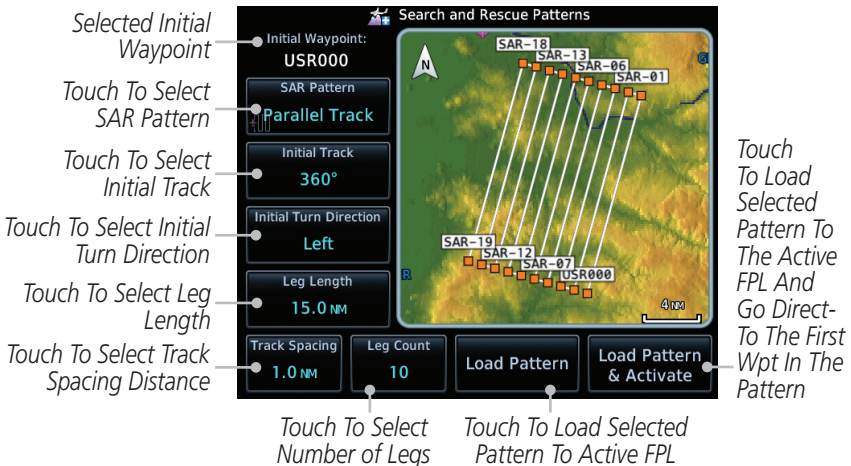

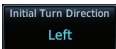
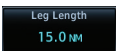
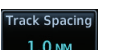





Figure 4-34 Search and Rescue Parallel Track Pattern Page

Foreword	
Getting Started	
Audio & Xpdr Ctrl	
Com/Nav	
FPL	
Direct-To	
Proc	
Charts	
Wpt Info	
Map	
Traffic	
Terrain	
Weather	
Nearest	
Services/ Music	
Utilities	
System	
Messages	
Symbols	
Appendix	
Index	

1. Touch the **SAR Pattern** key and select Parallel Track as the pattern type.
2. Touch the **Initial Track** key to open the keypad. Use the keypad and **Enter** to select the initial course.
3. Touch the **Initial Turn Direction** key to select between Left or Right as the initial turn direction.
4. Touch the **Leg Length** key to open the keypad. Use the keypad and **Enter** to select the length of the parallel track legs.
5. Touch the **Track Spacing** key to open the keypad. Use the keypad and **Enter** to select the desired spacing between the parallel track legs.
6. Touch the **Leg Count** key to open the keypad. Use the keypad and **Enter** to select the desired number of parallel track legs.
7. Touch the **Load Pattern** key to load selected pattern to the active flight plan.

OR

8. Touch the **Load Pattern & Activate** key to load selected pattern to the active flight plan and go direct-to the initial waypoint.

4.2.4.2 Creating a Sector Search Pattern

The Sector Search SAR pattern starts at the initial waypoint and follows the initial track for the desired leg length. A 60° turn in the initial turn direction is followed by another leg with the desired leg length, another 60° turn, and then a leg back to the initiating waypoint. The next sector starts with a leg continuing on the same course outbound from the initiating waypoint and is followed by the same sequence of legs and turns. The third sector follows the same pattern. The default initial track for the Sector Search Pattern is True North.

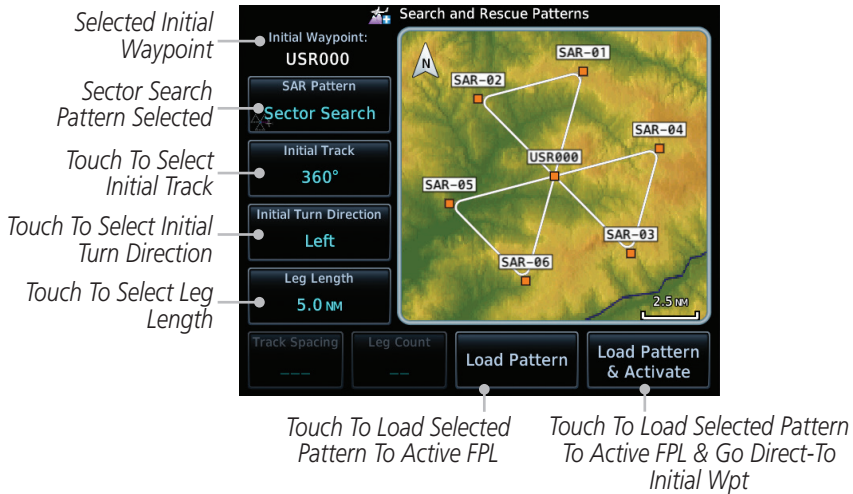

Figure 4-35 Search and Rescue Sector Search Pattern Page

1. Touch the **SAR Pattern** key and select Sector Search as the pattern type.
 2. Touch the **Initial Track** key to open the keypad. Use the keypad and **Enter** to select the initial course.
 3. Touch the **Initial Turn Direction** key to select between Left or Right as the initial turn direction.
 4. Touch the **Leg Length** key to open the keypad. Use the keypad and **Enter** to select the length of the parallel track legs.
 5. Touch the **Load Pattern** key to load selected pattern to the active flight plan.
- OR
6. Touch the **Load Pattern & Activate** key to load selected pattern to the active flight plan and go direct-to the initial waypoint.

4.2.4.3 Creating an Expanding Square Pattern

The Expanding Square SAR pattern starts at the initial waypoint and follows the initial track for a distance equal to the track spacing. All turns in the expanding square pattern are in the initial turn direction. All legs in the expanding square pattern are separated by the track spacing distance. The default initial track for the Expanding Square Pattern is 090°T.

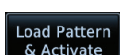
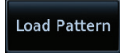

Figure 4-36 Search and Rescue Expanding Square Pattern Page

1. Touch the **SAR Pattern** key and select Expanding Square as the pattern type.
2. Touch the **Initial Track** key to open the keypad. Use the keypad and **Enter** to select the initial course.
3. Touch the **Initial Turn Direction** key to select between Left or Right as the initial turn direction.
4. Touch the **Track Spacing** key to open the keypad. Use the keypad and **Enter** to select the desired spacing between the parallel track legs.
5. Touch the **Leg Count** key to open the keypad. Use the keypad and **Enter** to select the desired number of legs.
6. Touch the **Load Pattern** key to load selected pattern to the active flight plan.

OR

7. Touch the **Load Pattern & Activate** key to load selected pattern to the active flight plan and go direct-to the initial waypoint.



4.2.4.4 Creating an Orbit Pattern

The Orbit SAR pattern is a fixed radius turn around the specified center waypoint. Automatic waypoint sequencing will be suspended while flying the orbit pattern.

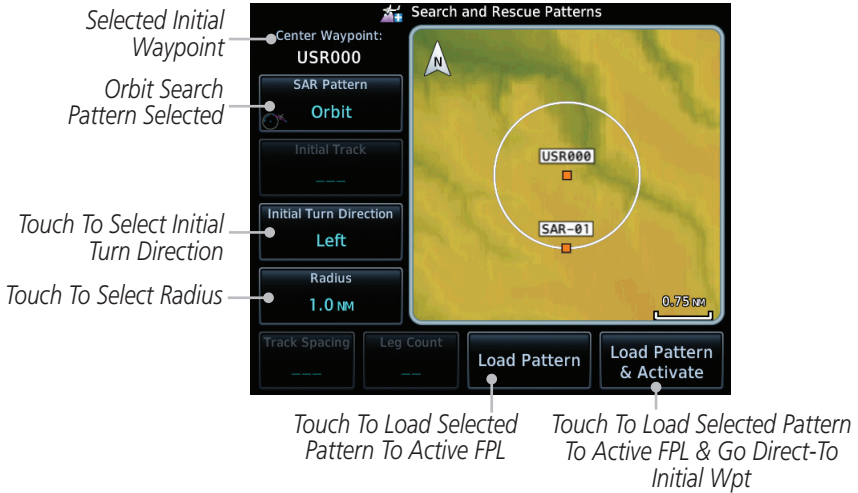
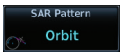
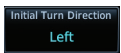

Figure 4-37 Search and Rescue Orbit Pattern Page



1. Touch the **SAR Pattern** key and select Orbit as the pattern type.



2. Touch the **Initial Turn Direction** key to select between Left or Right as the turn direction.



3. Touch the **Radius** key to open the keypad. Use the keypad and **Enter** to select the radius of the orbit pattern.

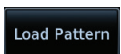

4. Touch the **Load Pattern** key to load selected pattern to the active flight plan.

OR

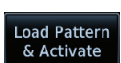

5. Touch the **Load Pattern & Activate** key to load selected pattern to the active flight plan and go direct-to the first waypoint in the pattern.

4.3 Flight Plan Menu

The Flight Plan Menu provides access to functions to manage your flight plans. The functions included are: View Catalog, Store Flight Plan, Delete Flight Plan, Preview Flight Plan, Parallel Track, Invert Flight Plan, and Edit Data Fields.



Touch the **Menu** key to access Flight Plan menu options.

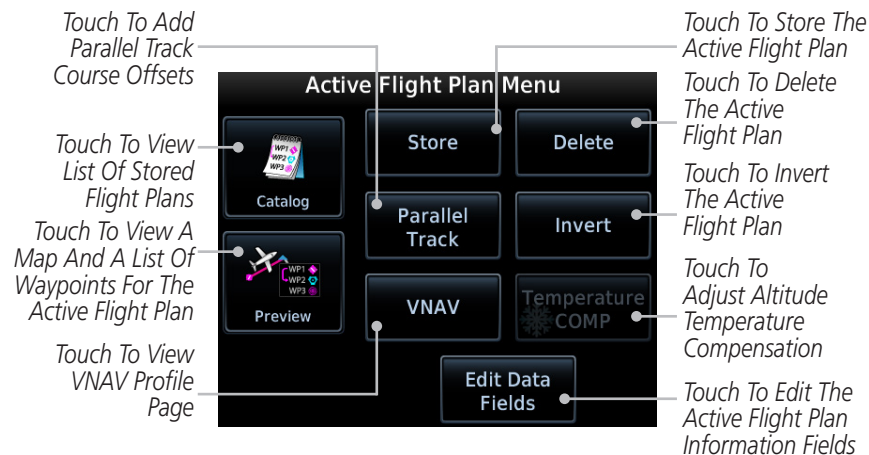

Figure 4-38 Flight Plan Menu

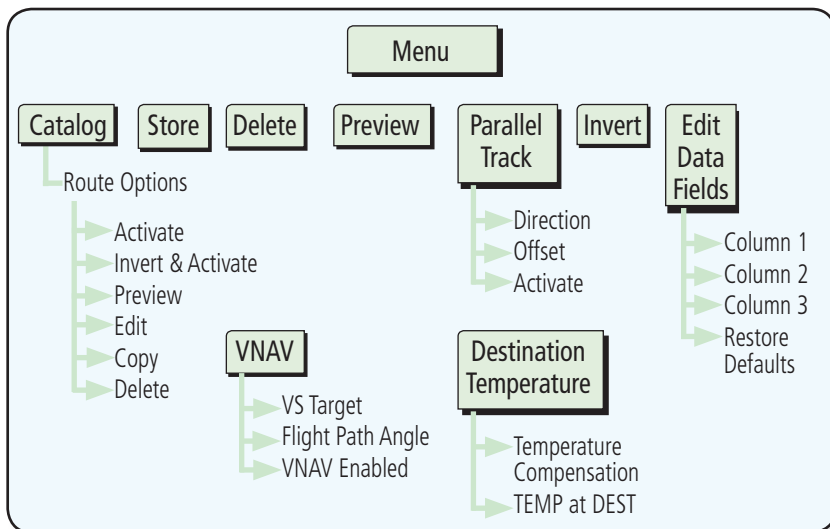

Figure 4-39 Flight Plan Menu Functional Diagram

4.3.1 Store Flight Plan

A flight plan must be saved to the Catalog to be used in future flights. The Store Flight Plan function will save the Active Flight Plan to the Catalog.



NOTE: *If a flight plan that includes a procedure that has been modified by the pilot is saved into the flight plan catalog, the GTN cannot check the accuracy of that procedure when that flight plan is used on a later flight. It is recommended that flight plans with modified procedures not be saved in the flight plan catalog.*

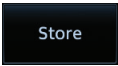

1. While viewing the Active Flight Plan page, touch the **Menu** key. The Flight Plan menu opens.
2. Touch the **Store** key to store the current Active Flight Plan into the Catalog. The flight plan will be named by the beginning and ending waypoints.
3. When a duplicate flight plan is created, a warning dialog will appear and the flight plan will be saved with a numeral at the end of the destination waypoint.

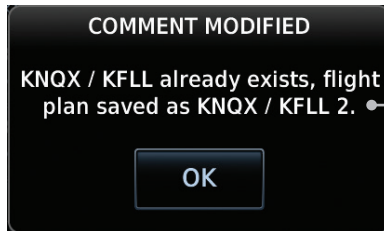

Duplicate Flight Plan

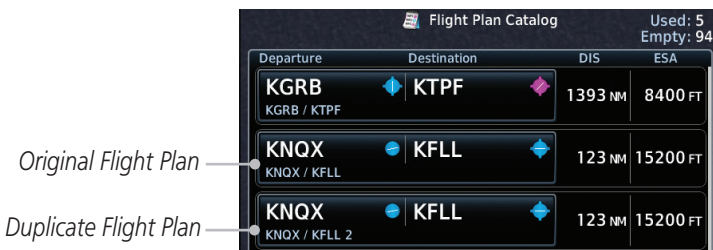

Figure 4-40 Duplicate Flight Plan Naming

4.3.2 Invert Flight Plan



NOTE: *Inverting a flight plan removes all ATKs.*

This option allows you to reverse the active flight plan and use it for navigation guidance back to your original departure point. The original flight plan stored in the catalog is not affected.



1. While viewing the Active Flight Plan page, touch the **Menu** key. The Flight Plan menu opens.

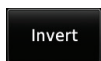

2. Touch **Invert**.

4.3.3 En Route Vertical Navigation



NOTE: *This feature is available in software v6.50 and later.*

The vertical navigation (VNAV) feature provides vertical profile guidance during the descent phase of flight. Guidance is based on altitude constraints associated with lateral waypoints in the active flight plan. Functions:

- Presents vertical path guidance to the descending path as either a line joining two waypoints with specified altitudes or a linear deviation from the desired path (i.e., the vertical angle from the specified waypoint or altitude)
- Integrates vertical waypoints into the active flight plan
- Supports both manual and autopilot coupling

4.3.3.1 VNAV Requirements

- Enablement by the installer
- A baro-corrected altitude source

If en route vertical navigation is not enabled, the GTN provides a single waypoint vertical calculator. For more information, refer to section 15.1.

For installation details related to en route vertical navigation, consult the AFMS.

4.3.3.2 VNAV Limitations

The GTN allows you to create a vertical navigation path with multiple altitude constraints in the flight plan. These altitudes are removed when the flight plan is stored in the flight plan catalog.

Most flight plan waypoints may be assigned an altitude constraint for use in vertical navigation. Exceptions include:

- Flight plan legs containing headings
- Flight plan legs that terminate at an altitude (e.g., a climb to 1,800 ft before making a turn and proceeding direct to fix)

4.3.3.3 VNAV Profile Page

Active vertical navigation profile information displays on the VNAV Profile page. This page is accessible from both the Flight Plan menu and the Utilities page.

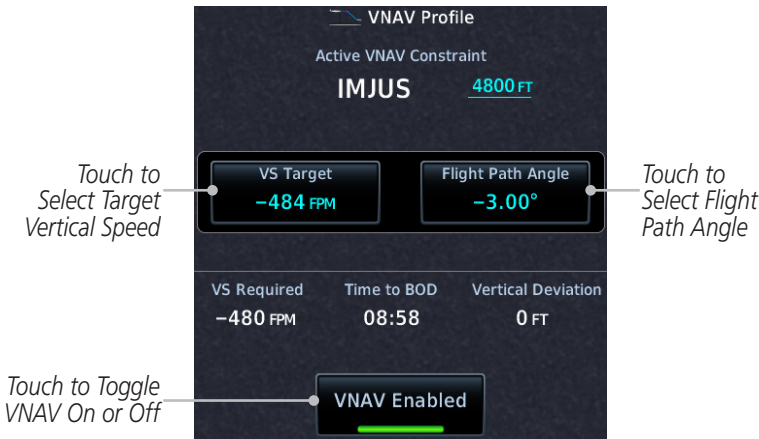

Figure 4-41 VNAV Profile Page

To enable VNAV guidance:



1. While viewing the Active Flight Plan page, touch **Menu**.



2. Select **VNAV**. The VNAV Profile page opens.

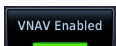

3. Touch **VNAV Enabled**.

To disable VNAV guidance, touch **VNAV Enabled** again.

Disabling vertical navigation:

- Invalidates required vertical speed, time to Top of Descent (TOD)/Bottom of Descent (BOD), and vertical deviation data
- Removes vertical deviation and required vertical speed indications from the PFD

VS Required	Time to TOD	Vertical Deviation
---- FPM	--:--	----- FT

VS Required, Time to TOD/BOD, and Vertical Deviation fields display dashes when VNAV is off

VNAV automatically re-enables when the pilot initiates a Direct-To.

4.3.3.4 Altitude Constraints



NOTE: Altitude constraints loaded from the database are jet altitudes. Some adjustment may be necessary for other types of aircraft. For the adjustment procedure, refer to the published chart.

Depending on the specific instance, altitude constraints are either manually entered into the Active Flight Plan page, or automatically retrieved from the published altitudes in the navigation database.

Constraint values display in MSL or flight level (FL). Constraints at airports may be specified as MSL or AGL.

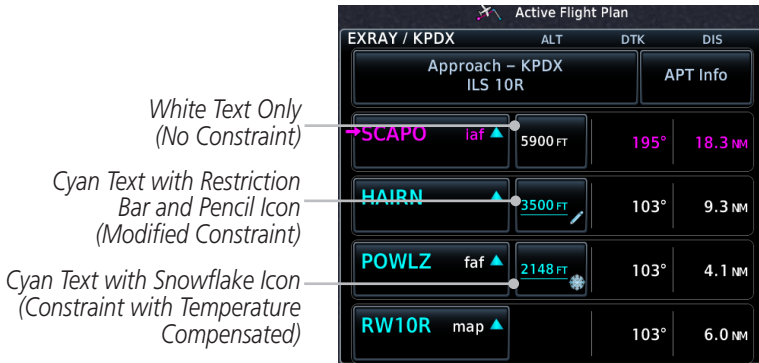

Figure 4-42 Waypoint Altitude Constraints

The system automatically uses altitudes loaded with arrival and approach procedures (up to and including the FAF) for computing vertical deviation guidance. These values, accompanied by an altitude restriction bar(s), display in cyan. The position of the value (above or below the bar, or between two bars) denotes the required aircraft altitude relative to that constraint. Dual values announce when the aircraft needs to cross between two altitudes.

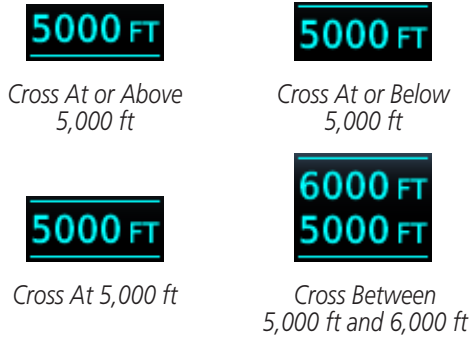

Figure 4-43 Altitude Constraint Examples

Indication	Color	Description
	White	<ul style="list-style-type: none"> Altitude calculated by system Estimate of aircraft altitude as it passes over the navigation point Absence of bar(s) indicates it is not a potential constraint
		<ul style="list-style-type: none"> Altitude retrieved from navigation database Bar above and/or below the value indicates constraint type Altitude is for reference only. Not for use in determining vertical guidance
	Cyan	<ul style="list-style-type: none"> Altitude designated for use in determining vertical guidance Pencil icon indicates manual designation or manual data entry
		<ul style="list-style-type: none"> Constraint invalid System cannot use altitude to determine vertical guidance

Table 4-1 Altitude Constraint Color Conventions

An altitude constraint is invalid if:

- Meeting the constraint requires the aircraft to climb
- Meeting the constraint requires the aircraft to exceed the maximum flight path angle (6° downward) or maximum vertical speed (-4,000 fpm)
- It results in a TOD behind the aircraft's current position
- It is within a leg type that does not support altitude constraints
- It is added to a waypoint past the FAF

The altitude restriction from the database displays when the following three conditions are present.

1. A pilot-specified altitude constraint is deleted
2. Navigation database contains an altitude restriction for the lateral waypoint
3. A predicted altitude is not available

Once added to the flight plan, an altitude constraint may be modified or deleted using the controls in the VNAV Options menu. Select a value in the ALT column to display available options.

Selection	Function
Type	<ul style="list-style-type: none"> • Opens a list of available constraint types • Options: At, At or Above, At or Below, and Between
Altitude Data Entry	<ul style="list-style-type: none"> • Opens a keypad. Specify an altitude value for the selected constraint type • Unit options: MSL, AGL, and Flight Level
Revert Constraint	<ul style="list-style-type: none"> • Returns a modified altitude constraint to its original published value
Remove Constraint	<ul style="list-style-type: none"> • Removes the VNAV designation from the altitude • Value remains displayed for reference purposes. It is no longer used to compute vertical guidance • Removing the VNAV designation from an altitude may invalidate other displayed altitudes or cause them to change after recalculation

Table 4-2 Altitude Constraint Options

To designate a waypoint altitude for use with vertical guidance:

1. Select a waypoint altitude constraint.
2. Touch **Save**.



The altitude color changes to cyan, indicating it is usable for vertical guidance.

To enter or modify an altitude constraint:

1. Select an altitude constraint.
2. Touch **Type** and select the constraint type.



3. Select the altitude data key. Enter an altitude constraint value using the keypad. Touching **Flight Level** enters the value as a flight level.

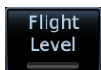

4. Touch **Enter** to accept the altitude.



5. Touch **Save**.



To delete an altitude constraint:

1. Select an altitude constraint.
2. Touch **Remove Constraint**.
3. Confirm the request by selecting **OK**.

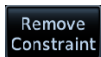

To return a modified altitude constraint to its original database value:

1. Select an altitude constraint containing the pencil icon.
2. Touch **Revert Constraint**.
3. Confirm the request by selecting **OK**.

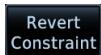

4.3.3.5 VNAV Direct-To

The VNAV Direct-To function creates a vertical navigation path from the aircraft's current position and altitude to a selected waypoint's location and altitude. By removing any VNAV constraints between the aircraft and the selected waypoint, it allows the pilot to fly the lateral flight plan in a continuous descent and reach the waypoint at the specified altitude.

To initiate a VNAV Direct-To:

1. Select an altitude constraint.
2. Touch **VNAV Direct-To**.
3. Confirm the request by selecting **OK**.



4.3.3.6 Transition to Approach

Function availability dependent on installer configuration. For more information, refer to the AFMS.

Approach Type	VNAV Response
Transition to Approach Enabled	<ul style="list-style-type: none"> • Vertical path attempts a smooth transition from en route to approach vertical guidance • Aircraft intercepts with approach guidance from below the glidepath/glideslope
Transition to Approach Not Enabled	<ul style="list-style-type: none"> • En route VNAV terminates at the waypoint prior to the FAF on approaches with vertical guidance • En route VNAV terminates at the FAF (LNAV only)

Table 4-3 VNAV Approach Response

4.3.4 Temperature Compensated Altitude



NOTE: GTNs and TXi displays use only one destination airport temperature for calculating compensated altitudes. Changing the temperature on one of these units automatically recalculates the value across all connected GTNs and GDUs.

A temperature compensation function calculates loaded approach altitudes based on the pilot-specified destination temperature. Once the pilot enters a destination temperature, the system increases the approach altitudes accordingly.

4.3.4.1 Temperature Compensation Requirements

- A destination airport is present in the active flight plan
- GDU 700()/1060 for access via PFD Minimums menu

4.3.4.2 Setting Temperature Compensated Altitude

Temperature compensation controls are accessible from two locations:

- Destination Temperature Compensation window
- Minimums menu (PFD only)

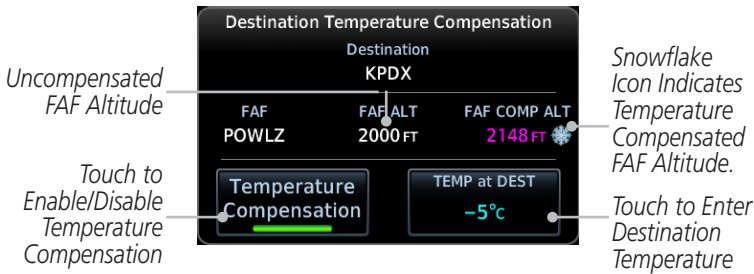

Figure 4-44 Destination Temperature Compensation Window

To activate temperature compensated altitude:



1. While viewing the Active Flight Plan page, touch **Menu**.



2. Touch **TEMP COMP**. The Destination Temperature Compensation pop-up opens.



3. Touch **Temperature Compensation**.



4. Touch **TEMP at DEST** and specify the destination airport temperature.

The temperature compensated FAF altitude displays in magenta.

4.3.5 Parallel Track



NOTE: *En route vertical navigation is unavailable while the parallel track function is active.*

Parallel track allows you to create a parallel course offset of 1 to 99 NM to the left or right of your current flight plan. After setting a parallel track to your current flight plan, a magenta parallel track line will be drawn offset from the original by the selected distance. The original course line will be drawn in gray. The aircraft will navigate to the parallel track course line and external CDI/HSI guidance will be driven from the parallel track.

When you reach the end of the flight plan, a message will state, “Parallel offset terminating in X seconds.” The message will be given when the aircraft reaches the offset distance from the end of the parallel track. This will give the pilot sufficient time to intercept the original course.

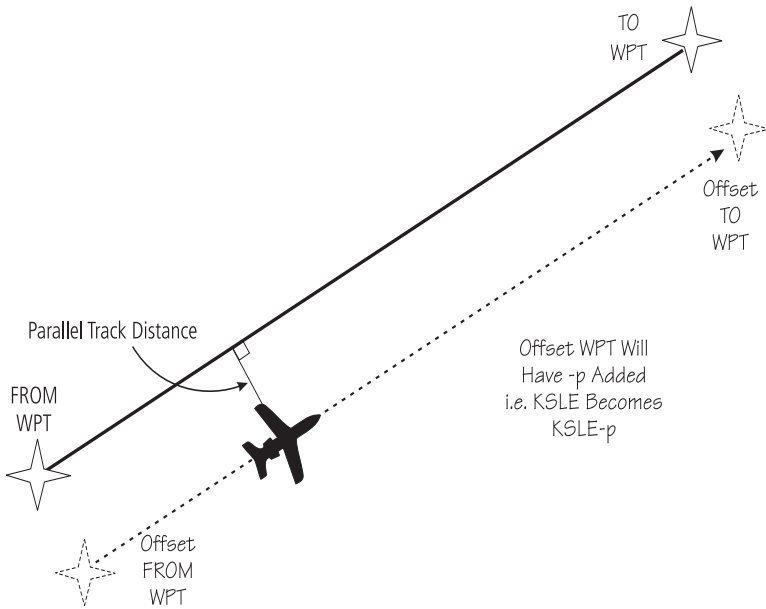

Figure 4-45 Parallel Track Description



NOTE: *In software v6.21 and earlier, graphically editing a flight plan cancels the parallel track function.*

- Foreword
- Getting Started
- Audio & Xpdr Ctrl
- Com/Nav
- FPL**
- Direct-To
- Proc
- Charts
- Wpt Info
- Map
- Traffic
- Terrain
- Weather
- Nearest
- Services/Music
- Utilities
- System
- Messages
- Symbols
- Appendix



NOTE: Certain leg types (such as approach) or leg geometries (changes in desire track greater than 120 degrees), combined with large offset values do not support parallel track. Default direction and offset values may result in the status indicating that parallel track is not supported. The user must enter the desired parallel track offset and distance to determine whether that flight plan, combined with the offset and distance, support parallel track.



1. While viewing the Flight Plan page, touch the **Menu** key, and then the **Parallel Track** key.



Figure 4-46 Parallel Track Selection



2. Touch the **Direction** key to toggle the Parallel Track to be Left or Right of the current Flight Plan.

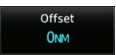

3. Touch the **Offset** key to select the Parallel Offset from the current Flight Plan. Select the desired distance on the numeric keypad. Touch **Enter** when finished.



4. Touch the **Activate** key. A magenta "-P" indication will appear to the right of the waypoint name on the Active Flight Plan page.

Foreword

Getting Started

Audio & Xpdr Ctrl

Com/Nav

FPL

Direct-To

Proc

Charts

Wpt Info

Map

Traffic

Terrain

Weather

Nearest

Services/
Music

Utilities

System

Messages

Symbols

Appendix



Figure 4-47 Parallel Track Shown in the Active Flight Plan Page

- To deactivate Parallel Track, while viewing the Active Flight Plan touch the **Menu** key. With the Flight Plan Menu displayed, touch the **Parallel Track** key.



Figure 4-48 Deactivating Parallel Track

- Touch the **Deactivate** key to cancel Parallel Tracking.



4.3.6 Edit Data Fields

The Active Flight Plan Page shows each waypoint for the flight plan, along with the Desired Track (DTK), Distance (DIS) for each leg, and Cumulative Distance (CUM). Data fields are user-selectable and may be changed to display:

- | | |
|---------------------------|---------------------------------|
| ALT - Altitude | ESA - En Route Safe Altitude |
| CUM - Cumulative Distance | ETA - Estimated Time of Arrival |
| DIS - Distance | ETE - Estimated Time En route |
| DTK - Desired Track | FPA - Flight Path Angle |

When configured for VNAV, the GTN automatically selects the altitude data field for the first column.

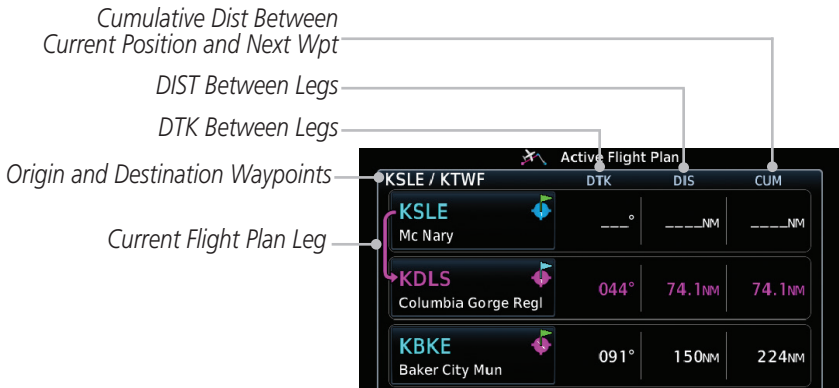

Figure 4-49 Flight Plan Data Fields



1. While viewing the Flight Plan page, touch the **Menu** key, and then the **Edit Data Fields** key.

Foreword
 Getting Started
 Audio & Xpdr Ctrl
 Com/Nav
FPL
 Direct-To
 Proc
 Charts
 Wpt Info
 Map
 Traffic
 Terrain
 Weather
 Nearest
 Services/
 Music
 Utilities
 System
 Messages
 Symbols
 Appendix

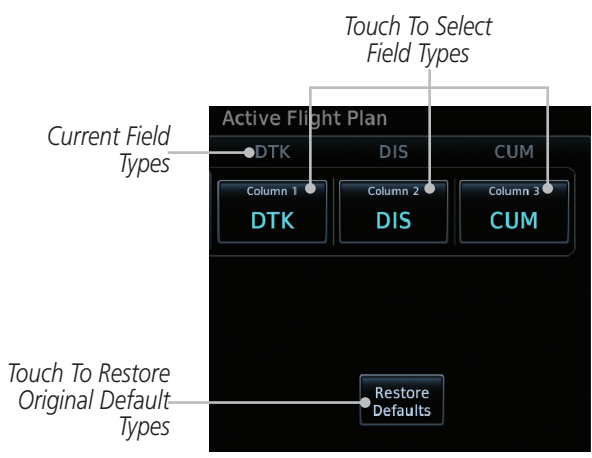

Figure 4-50 Flight Plan Edit Data Fields Page

2. Touch one of the field keys to select from the list.

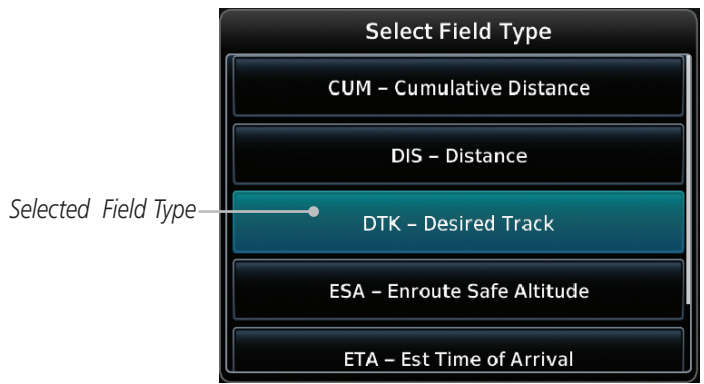
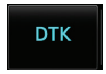

Figure 4-51 Flight Plan Data Fields List

3. Touch the **Up** or **Down** keys as needed, or touch and drag the list, to scroll through the list. Touch the desired Field Type to set it for the selected field.
4. Continue as desired for the other fields.



4.3.7 Flight Plan Catalog Route Options

The Flight Plan Catalog allows you to create, edit, activate, delete and copy flight plans. The catalog can hold up to 99 flight plans of up to 100 waypoints each. Flight plans are named by the Departure and Destination waypoint. Any time you activate a flight plan, a copy of the flight plan is automatically transferred to Active Flight Plan page and overwrites any previously active flight plan.

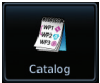

1. While viewing the Flight Plan page, touch the **Menu** key, and then the **Catalog** key. The list of currently stored flight plans will be displayed.



Figure 4-52 Flight Plan Catalog

2. Touch a flight plan to display the Route Options.



Figure 4-53 Flight Plan Catalog Route Options

3. Touch the Route Option key for the desired option to act on the selected flight plan.

4.3.7.1 Catalog Route Option - Activate

1. While viewing the Flight Plan Catalog page, touch the desired flight plan to select it. The Route Options menu will be displayed.
2. Touch the **Activate** key and then touch **OK**. The selected flight plan will be activated.

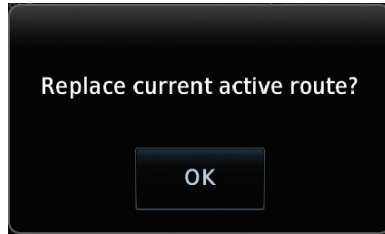
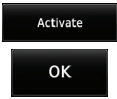

Figure 4-54 Touch OK to Replace the Existing Active Flight Plan

3. The Active Flight Plan page will now be displayed.

4.3.7.2 Catalog Route Option - Invert & Activate



NOTE: Inverting a flight plan removes all ATCs.

1. While viewing the Flight Plan Catalog page, touch the desired flight plan to select it. The Route Options menu will be displayed.
2. Touch the **Invert & Activate** key and then touch **OK**. The selected flight plan will be inverted and activated.

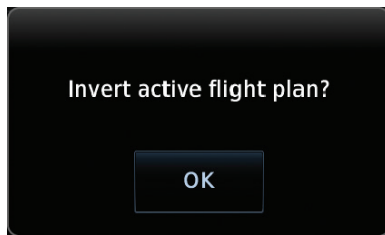

Figure 4-55 Touch OK to Invert and Activate the Selected Flight Plan

4.3.7.3 Catalog Route Option - Preview

1. While viewing the Flight Plan Catalog page, touch the desired flight plan to select it. The Route Options menu will be displayed.
2. Touch the **Preview** key. A map view of the flight plan and list of the waypoints will be displayed.
3. Touch the **Back** key to return to the Flight Plan Catalog.



4.3.7.4 Catalog Route Option - Edit

1. While viewing the Flight Plan Catalog page, touch the desired flight plan to select it. The Route Options menu will be displayed.
2. Touch the **Edit** key. The flight plan will be displayed. Make any changes necessary by touching the desired waypoint and using the Waypoint Options.



Selected Waypoint

Waypoint Options List

Figure 4-56 Use Waypoint Options to Edit the Selected Flight Plan



3. Touch the **Back** key to return to the Flight Plan Catalog.

4.3.7.5 Catalog Route Option - Copy

1. While viewing the Flight Plan Catalog page, touch the desired flight plan to select it. The Route Options menu will be displayed.
2. Touch the **Copy** key. You will be prompted to copy the selected flight plan.

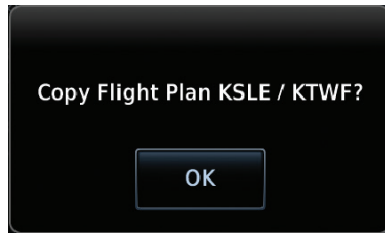

Figure 4-57 Flight Plan Catalog Route Copy Option

3. A copy of the selected flight plan will now be listed. If any changes are required for the copy, it can be used as a starting point for a similar flight plan. Use the Edit Route option to make the desired changes.

Duplicate Copy Of Selected Flight Plan



Figure 4-58 Copied Flight Plan

4. Touch the **Back** key to return to the Active Flight Plan.



Foreword
Getting Started
Audio & Xpdr Ctrl
Com/Nav
FPL
Direct-To
Proc
Charts
Wpt Info
Map
Traffic
Terrain
Weather
Nearest
Services/Music
Utilities
System
Messages
Symbols
Appendix

4.3.7.6 Catalog Route Option - Delete

1. While viewing the Flight Plan Catalog page, touch the desired flight plan to select it. The Route Options menu will be displayed.
2. Touch the **Delete** key and then touch **OK**.

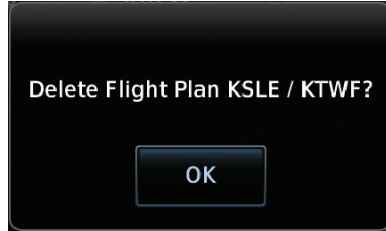
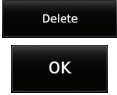

Figure 4-59 Delete the Selected Flight Plan from the Catalog



3. Touch the **Back** key to return to the Active Flight Plan.

4.3.8 Delete Flight Plan

There are three ways to delete a flight plan.

1. Remove a selected flight plan from the catalog.
2. Remove all flight plans from the catalog.
3. Remove all waypoints from the active flight plan.

4.3.8.1 Delete Flight Plan from Catalog



1. While viewing the Flight Plan page, touch the **Menu** key, and then the **View Catalog** key. The list of currently stored flight plans will be displayed.

Foreword
Getting Started
Audio & Xpdr Ctrl
Com/Nav
FPL
Direct-To
Proc
Charts
Wpt Info
Map
Traffic
Terrain
Weather
Nearest
Services/ Music
Utilities
System
Messages
Symbols
Appendix



Figure 4-60 Select a Flight Plan from the Catalog

2. Touch the **Delete** and then the **OK** key. The selected flight plan will be removed from the Catalog.

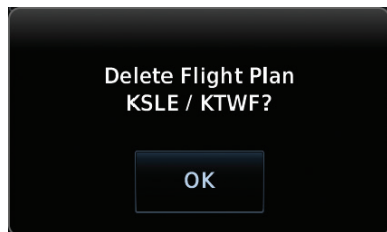
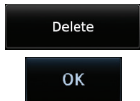

Figure 4-61 Delete a Flight Plan from the Catalog

4.3.8.2 Delete All Flight Plans from Catalog



NOTE: This feature is available in software v6.20 or later.



1. While viewing the Flight Plan Catalog, touch the **Menu** key to open the Flight Plan Catalog Menu.

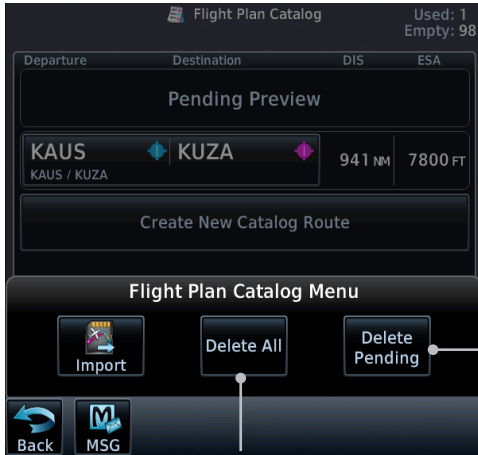

Touch to Delete All Flight Plans Pending

Touch to Delete All Catalog Flight Plans

Figure 4-62 Flight Plan Catalog Menu



2. Touch **Delete All** to remove all flight plans in the catalog.



3. Touch **Delete Pending** to remove all flight plans pending preview in the catalog.

4.3.8.3 Delete Active Flight Plan

1. While viewing the Active Flight Plan page, touch the **Menu** key, and then the **Delete Flight Plan** key.

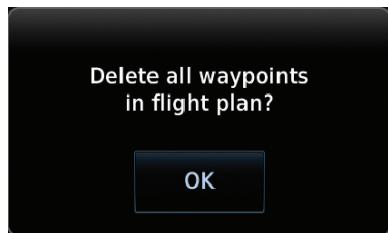

Figure 4-63 Delete a Flight Plan from the Active Flight Plan

2. Touch **OK** to clear the waypoints from the Active Flight Plan. The flight plan will not be removed from the Catalog.



- Foreword
- Getting Started
- Audio & Xpdr Ctrl
- Com/Nav
- FPL**
- Direct-To
- Proc
- Charts
- Wpt Info
- Map
- Traffic
- Terrain
- Weather
- Nearest
- Services/ Music
- Utilities
- System
- Messages
- Symbols
- Appendix

4.3.9 Preview Flight Plan

The Preview Flight Plan function provides a summary of a flight plan. A preview of the Active Flight Plan can be selected from the Flight Plan Menu's **Preview Flight Plan** key or selecting a flight plan from the catalog and choosing Preview from the Route Options menu.

4.3.9.1 Previewing the Active Flight Plan

1. While viewing the Flight Plan page, touch the **Menu** key, and then the **Preview** key. A preview of the Active Flight Plan will be shown.

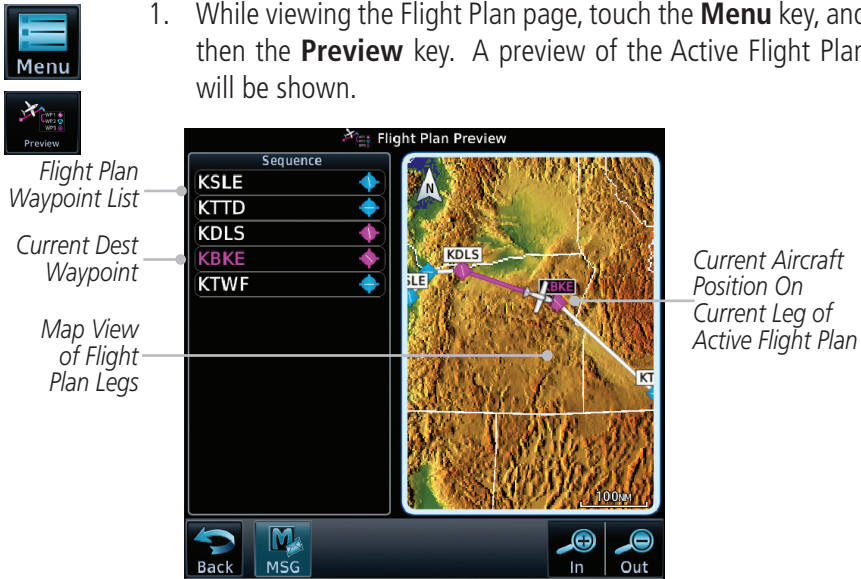

Figure 4-64 Active Flight Plan Preview

2. Touch the **Back** key to return to the Active Flight Plan page.



4.3.9.2 Previewing a Flight Plan in the Catalog

1. While viewing the Flight Plan page, touch the **Menu** key, and then the **Catalog** key. The list of currently stored flight plans will be displayed.
2. Touch the desired flight plan. The Route Options will now be displayed.
3. Touch the **Preview** key to display a preview of the selected flight plan.
4. Touch the **Back** key to return to the Flight Plan Catalog.



4.4 Graphically Editing a Flight Plan

The Active Flight Plan may be edited graphically on the Map page. See section 9.3.3 for details.

4.5 Import Flight Plans with Connex

When the GTN is interfaced with a compatible Flight Stream device, flight plans can be wirelessly imported into the GTN from supported Apps (i.e., Garmin Pilot). The imported flight plans can then be activated or stored to the flight plan catalog once they are previewed by the pilot.



NOTE: Flight plans over 99 waypoints long are truncated at 99 waypoints and the last waypoint in the imported/uploaded flight plan may not be the destination airport.



NOTE: Flight plan information and user waypoints included as part of a flight plan will not necessarily retain their names when the flight plan is transferred from the portable device to the GTN via a Flight Stream device. Whenever a User Waypoint is imported, it is compared to the existing User Waypoint catalog. If it matches locations with an existing User Waypoint, the waypoint will utilize the name saved in the GTN for that waypoint. If there is not a location match, the waypoint is imported but without the name label that the import software may have used. Therefore all new User Waypoints will come in as *USR###* where the number is the lowest open User Waypoint slot in the catalog.



NOTE: This feature is available in software v5.10 and later.

4.5.1 Operation

On the portable device, select the option to send a flight plan to the GTN. The GTN **MSG** key will appear and begin to flash.

1. Pressing the **MSG** key will open the message page with a message showing how many flight plans are ready to preview.

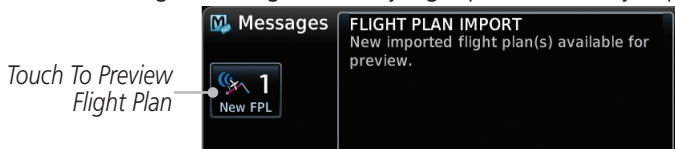

Figure 4-65 Flight Plan Import Message



- Touch the **New FPL** key to open the flight plan preview page when only one flight plan is imported, or the flight plan catalog when more than one flight plan is imported.

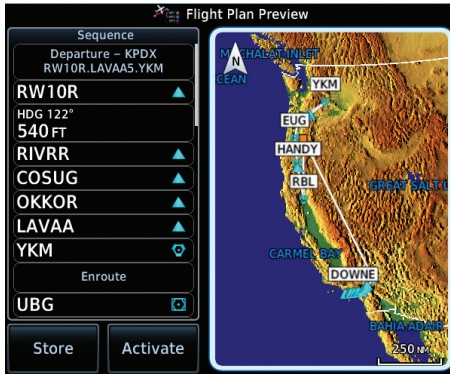

Figure 4-66 Preview for Single Flight Plan Import

Touch To Select The Desired Catalog →



Figure 4-67 Catalog for Multiple Flight Plan Import

- Selecting a flight plan in the catalog that is "Pending Preview" will slide out a menu to preview or delete the flight plan. Once the flight plan has been previewed and then stored or activated, the other Route Options in the menu will be available.

Foreword

Getting Started

Audio & Xpdr Ctrl

Com/Nav

FPL

Direct-To

Proc

Charts

Wpt Info

Map

Traffic

Terrain

Weather

Nearest

Services/ Music

Utilities

System

Messages

Symbols

Appendix

Index

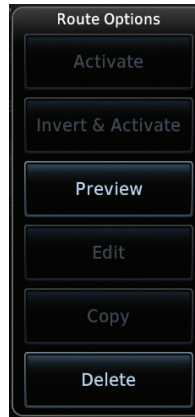

Figure 4-68 Route Options by Selecting Flight Plan with Pending Review

4.5.2 Potential Errors

If the GTN is unable to import a flight plan due to errors in the flight plan or a full catalog, the pilot will be alerted with a system message.



Figure 4-69 Flight Plan Import Error Messages

If an imported flight plan contains any errors, pop-up messages will be displayed alerting the pilot of the issues and the resulting changes to the flight plan.

When the imported flight plan is too long, the GTN will truncate the flight plan to the correct length. The pilot should be aware that waypoints are missing from the end of the flight plan, including the destination waypoint.

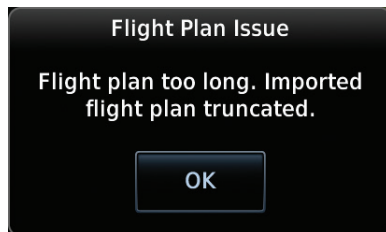

Figure 4-70 Pop-Up Message Reporting Flight Plan Errors

When the imported flight plan contains waypoints (non-user waypoints), procedures, or airways that are not found in navigation database, the GTN will replace those waypoints with locked (lockd) waypoints. These locked waypoints must be resolved prior to activating the flight plan to provide navigation along the flight plan.

When more than one error occurs during the flight plan import, the pilot will need to cycle through the errors by touching the **Next** key on the pop-up.

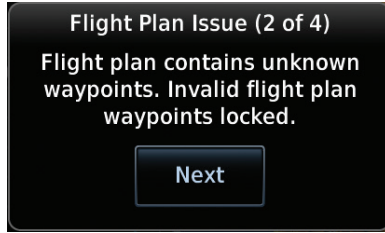

Figure 4-71 Pop-Up Message Reporting Unknown Waypoints

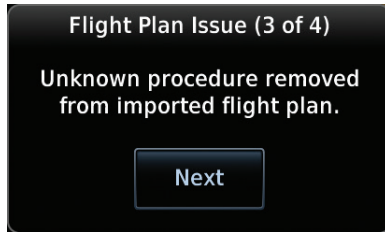

Figure 4-72 Pop-Up Message Reporting Unknown Procedure

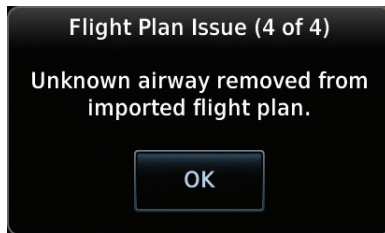

Figure 4-73 Pop-Up Message Reporting Unknown Airway

4.6 Import Flight Plans with a Datacard

Flight plans can be created on a computer using compatible flight planning software and saved to a datacard to be imported into the GTN. The imported flight plans can then be activated or stored to the flight plan catalog once they are previewed by the pilot.



NOTE: Flight plans over 99 waypoints long are truncated at 99 waypoints and the last waypoint in the imported/uploaded flight plan may not be the destination airport.



NOTE: This feature is available in software v5.10 and later.



NOTE: The flight plan file format used by the GTN is different than the file format used by the GNS 400W/500W Series navigators.



1. While viewing the Flight Plan page, touch the **Menu** key and then the **Catalog** key to display the Flight Plan Catalog.

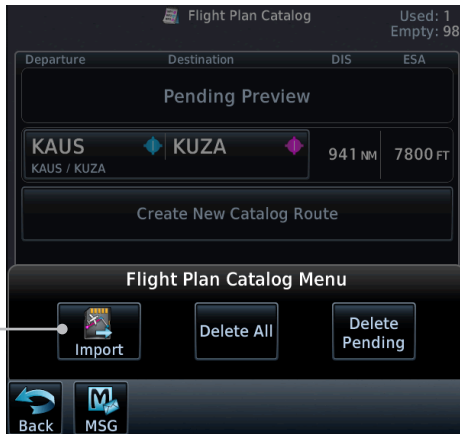

Touch To Import Flight Plan

Figure 4-74 Catalog for Datacard Flight Plan Import

2. An **Import** key will be present in the menu when flight plans are present on the datacard. Touch the **Import** key to open a pop-up with a list of the file names of the flight plans on the datacard.



Touch To Import Flight Plan From Datacard

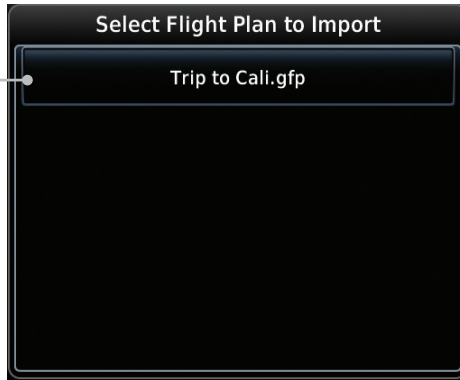

Figure 4-75 Flight Plan To Import From Datacard

3. Select the desired flight plan to import.
4. Press **Store** to save the flight plan to the catalog. Press **Activate** to make the imported flight plan the active route.

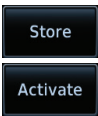

Figure 4-76 Route Options For SD Card Flight Plan Import

Touch To Store To Save Flight Plan To The Catalog

Touch To Make The Imported Flight Plan The Active Route

4.6.1 Potential Errors

If the GTN is unable to import a flight plan due to errors in the flight plan or a full catalog, the pilot will immediately be alerted with a pop-up.

OK

1. Touch **OK** at the prompt to continue.

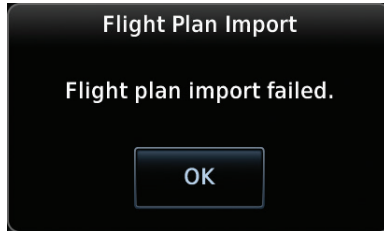

Figure 4-77 Flight Plan Import Fault



Figure 4-78 Flight Plan Import Fault - Catalog Full

OK

2. If an imported flight plan contains any errors, pop-up messages will be displayed alerting the pilot of the issues and the resulting changes to the flight plan. These pop-ups are presented the first time that the flight plan is viewed on the Flight Plan Preview page.

When the imported flight plan is too long, the GTN will truncate the flight plan to the correct length. The pilot should be aware that waypoints are missing from the end of the flight plan.

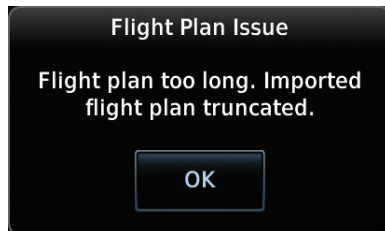

Figure 4-79 Flight Plan Import Issue - Flight Plan Too Long

- When the imported flight plan contains waypoints (non-user waypoints), procedures, or airways that are not found in navigation database, the GTN will replace those waypoints with locked waypoints. These locked waypoints must be resolved prior to activating the flight plan.

Next

When more than one error occurs during the flight plan import, the pilot will need to cycle through the errors by touching the **Next** key on the pop-up.

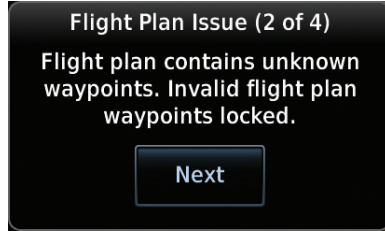

Figure 4-80 Flight Plan Import Issue - Flight Plan Contains Unknown Waypoints

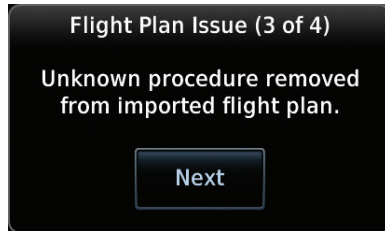

Figure 4-81 Flight Plan Import Issue - Unknown Procedure Removed From Flight Plan

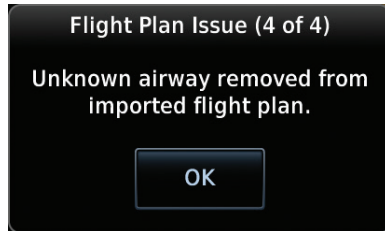

Figure 4-82 Flight Plan Import Issue - Unknown Airway Removed From Flight Plan

Foreword

Getting
Started

Audio &
Xpdr Ctrl

Com/Nav

FPL

Direct-To

Proc

Charts

Wpt Info

Map

This page intentionally left blank

Traffic

Terrain

Weather

Nearest

Services/
Music

Utilities

System

Messages

Symbols

Appendix

5 DIRECT-TO

The GTN 7XX Direct-To function can quickly set a course to any waypoint. If the pilot selects Direct-To to a waypoint that is in the flight plan, waypoint sequencing in the flight plan will resume upon reaching that waypoint. If the pilot selects Direct-To for a waypoint that is not in the flight plan, the flight plan will no longer be active but remains available. There are some fixes within procedures for which if a Direct-To is selected then the approach will not be active. For example, if you activate a Direct-To course to a waypoint between the FAF and the MAP and go Direct-To to that waypoint then approach guidance will not become active.

5.1 Direct-To Navigation



1. Press the **Direct-To** key on the right side of the unit.



Figure 5-1 Direct-To Wpt Page

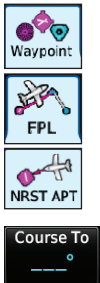

2. Select **Waypoint**, **FPL**, or **NRST APT** from the Direct-To window by touching the desired tab.
3. If a specific course is desired, touch the **Course To** key.

Foreword
Getting Started
Audio & Xpdr Ctrl
Com/Nav
FPL
Direct-To
Proc
Charts
Wpt Info
Map
Traffic
Terrain
Weather
Nearest
Services/Music
Utilities
System
Messages
Symbols
Appendix



- Use the numeric keypad to select the course and then touch the **Enter** key.

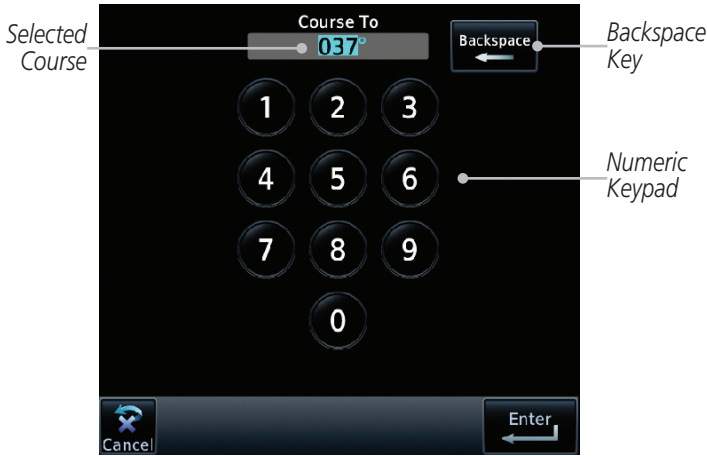

Figure 5-1 Direct-To Course Selection



- Touch the desired waypoint and touch the **Activate** key or press the **small right** knob.



Figure 5-2 Direct-To Selection

- The Map page will now be displayed with the new Direct-To course.

5.2 Direct-To a Flight Plan Waypoint

The Direct-To selection is not available for all flight plan entries. Some flight plan entries including holds and course reversals cannot be selected using Direct-To. Instead, select the associated waypoint for the Direct-To function.



1. Press the **Direct-To** key on the right side of the unit.
2. Touch the **FPL** tab at the top of the Direct-To window.



Figure 5-3 Direct-To Flight Plan Leg Selection

3. Touch the flight plan waypoint you want to navigate directly to. The Direct-To Waypoint page will display information about the selected flight plan waypoint.

Foreword
 Getting Started
 Audio & Xpdr Ctrl
 Com/Nav
 FPL
Direct-To
 Proc
 Charts
 Wpt Info
 Map
 Traffic
 Terrain
 Weather
 Nearest
 Services/ Music
 Utilities
 System
 Messages
 Symbols
 Appendix

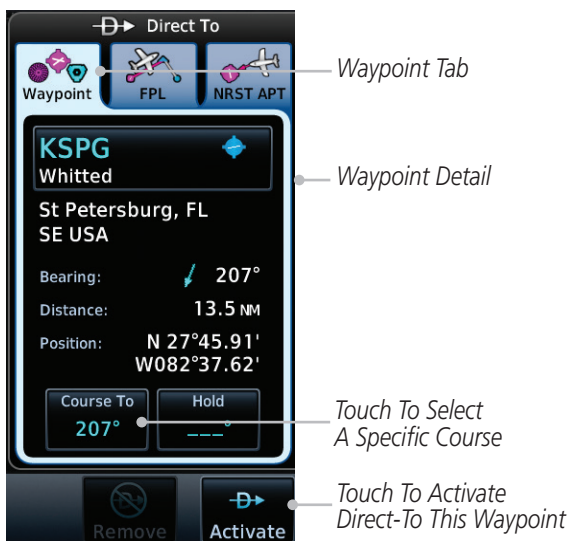
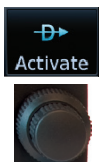

Figure 5-4 Selected Direct-To Flight Plan Leg

4. Touch the **Activate** key or press the **small right** knob to activate the selection.
5. The Map page will now be displayed with the new Direct-To course.



5.3 Direct-To a Nearest Airport



1. Press the **Direct-To** key on the lower right side of the unit.



2. Touch the **NRST APT** tab at the top of the Direct-To window. The nearest 25 airports within 200 NM will be listed. The airport at the top of the list is the nearest airport. To review the other nearest airports, touch the **Up** and **Down** keys to scroll through the list.



Figure 5-5 Direct-To Nearest Airport Selection

3. Touch the desired airport to select it. The selected airport will be displayed in the Waypoint page.



Figure 5-6 Selected Direct-To Nearest Airport

4. Touch the **Activate** key or press the **small right** knob to activate the selection.
5. The Map page will now be displayed with the new Direct-To course.

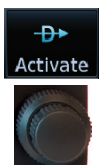

5.4 Removing a Direct-To Course

When a Direct-To course is cancelled, the previously active flight plan will be reactivated and the nearest leg to the aircraft position will become the active leg. If there was no active flight plan, after cancelling the Direct-To course the aircraft will continue with the current heading.

Foreword

Getting Started

Audio & Xpdr Ctrl

Com/Nav

FPL

Direct-To

Proc

Charts

Wpt Info

Map

Traffic

Terrain

Weather

Nearest

Services/
Music

Utilities

System

Messages

Symbols

Appendix



1. Press the **Direct-To** key to display the Direct-To page.



Figure 5-7 Cancel the Direct-To Course



2. Touch the **Remove** key.
3. Navigation will now return to the active flight plan.

5.5 Direct-To Map Waypoint

A Direct-To course may be set to any waypoint selected on the Map page. The waypoint is selected by touching an item such as an airport, VOR, or NDB or any other location. Touching the map page at any place not having an existing location name will create a waypoint with the name “MAPWPT.” Touching the **Direct-To** key will automatically insert the selected waypoint as the Direct-To waypoint.

1. On the Map page, touch the map at the location intended to be the Direct-To waypoint.
2. Press the **Direct-To** key on the right side of the unit.



Figure 5-8 Touch the Map to Create a MAPWPT as the Direct-To Course Destination

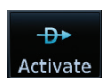

3. Touch the **Activate** key or press the **small right** knob to activate the selection.



5.6 Off-Route Direct-To Course

An off-route Direct-To course may be selected by using the Waypoint tab, Nrst Apt tab, or selecting a waypoint on the map. When an off-route Direct-To course is activated, the existing active flight plan will be deactivated. The original active flight plan and waypoint sequencing is reactivated when the Direct-To course is removed.



Figure 5-9 Active Flight Data is Removed When a Direct-To Course is Activated

5.7 Graphically Editing a Direct-To Route

Direct-To routes may be edited graphically on the Map page the same as a regular flight plan. See section 9.3.3 for details.

5.8 Direct-To a User-Defined Hold



NOTE: This feature is available in software v6.00 and later.



NOTE: Any time a user hold is changed with the Direct-To key, upon pressing the "Activate the Direct-To Hold" key, navigation guidance will be given back to the holding fix and the new hold re-initiated.

A user-defined hold can be created as part of a Direct-To to any waypoint. Automatic waypoint sequencing will be suspended during the hold.



1. Press the **Direct-To** key to display the Direct-To page.



Figure 5-10 Create Hold at Direct-To Waypoint

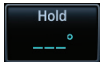

2. Touch the **Hold** key. The Direct-To Hold page is displayed.

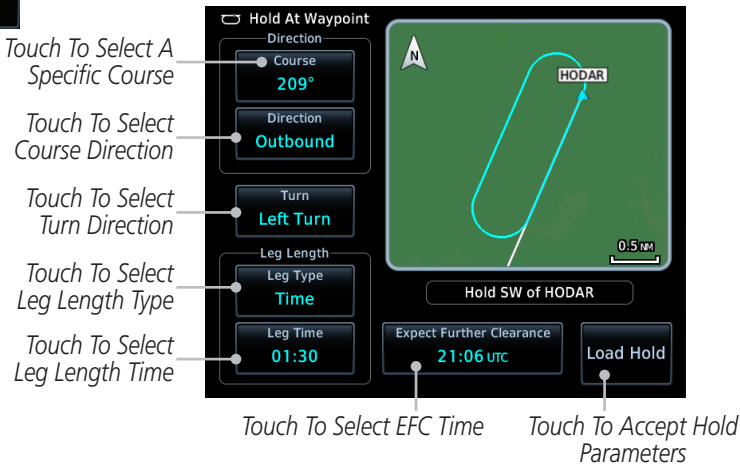
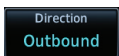

Figure 5-11 Entering Direct-To Hold Parameters



3. Touch the **Course** key to open the keypad. Use the keypad and the **Enter** key to select the inbound or outbound course.



4. Touch the **Course Direction** key to select between Inbound or Outbound for the course direction.

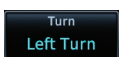

5. Touch the **Turn** key to select between Left or Right for the turn direction.

Leg Type
Time

6. Touch the **Leg Type** key to select between Time or Distance for the leg type.

Leg Time
01:30

7. Touch the **Leg Time** or **Leg Distance** key to display the keypad. Use the keypad and the **Enter** key to select the length of the leg.

Expect Further Clearance
21:06 UTC

8. Touch the **Expect Further Clearance** key to display the keypad. Use the keypad and the **Enter** key to select the time for a reminder.

Load Hold

9. Touch the **Load Hold** key to accept the hold parameters and return to the Direct-To page.

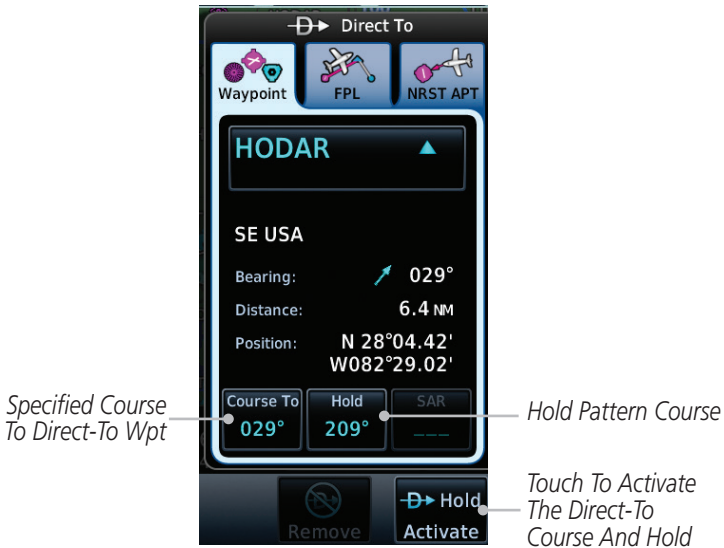

Figure 5-12 Direct-To Page with Hold Selected

Hold
Activate

10. Touch the **Hold Activate** key or press the **small right** knob to activate the selection.

5.9 Direct-To a Search and Rescue Pattern



NOTE: This feature is available in software v6.00 and later.

A search and rescue pattern can be created as part of a Direct-To for a flight plan, off-route, or map waypoint. Creating a SAR pattern as part of an off-route Direct-To will insert the SAR pattern waypoints at the end of the En Route portion of the active flight plan.

1. Press the **Direct-To** key to display the Direct-To page.



Direct-To Wpt

Touch To Select A Specific Course

Touch To Create SAR Pattern At Direct-To Wpt

Figure 5-13 Create SAR Pattern at Direct-To Waypoint

2. Touch the **SAR** key. The Direct-To Search and Rescue Patterns page is displayed.



Selected Initial Wpt

Touch To Select Desired SAR Pattern

Touch To Select Initial Track

Touch To Select Initial Turn Direction

Touch To Select Leg Length

Touch To Select Track Spacing Distance

Touch To Select Number Of Legs

Touch To Load Selected SAR Pattern to Direct-To

Figure 5-14 Direct-To Search and Rescue Pattern Page



3. Touch the **SAR Pattern** key to select between Parallel Track, Sector Search, Expanding Square, or Orbit for the SAR pattern type. The available patterns can be configured by the installer and all of the listed pattern types may not be available. See the section 4.2.4 Load Search and Rescue Pattern for more details on configuring each pattern type.

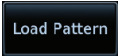

4. Confirm the SAR pattern information and then touch the **Load Pattern** key to accept the SAR parameters and return to the Direct-To page.



Figure 5-15 Direct-To Page with SAR Pattern Selected



5. Touch the **SAR Activate** key or press the **small right** knob to activate the selection.

Foreword

Getting
Started

Audio &
Xpdr Ctrl

Com/Nav

FPL

Direct-To

Proc

Charts

Wpt Info

Map

This page intentionally left blank

Traffic

Terrain

Weather

Nearest

Services/
Music

Utilities

System

Messages

Symbols

Appendix

6 PROCEDURES

The GTN 7XX allows you to fly non-precision and precision approaches to airports with published instrument approach procedures. The system can also provide visual approach guidance to most airports. Approach procedures are not the same as the approach plates available in ChartView or FliteCharts, which are separate databases.

The Procedures Page is displayed by touching the **PROC** key on the Home page. The Procedures Page provides access to approaches, departures and arrivals. Selections are also shown to: Activate Approach, Vectors to Final, and Activate Missed Approach.



NOTE: *With the exception of Charted Visual Flight Procedures (CVFPs), visual approaches do not have associated approach charts.*



NOTE: *The Chart feature provides a digital representation of a paper chart and provides no vertical or lateral course guidance. Flight Plan and Procedures are separate from Charts, and do provide vertical and lateral course guidance for the loaded route or procedure shown on the Flight Plan page. The term "Chart Unavailable" means that the chart cannot be viewed on the Charts due to either a chart not being published, or an error in the Chart database, but does not preclude its availability or inclusion of the procedure in the Flight Plan or Procedures portion of the system. The absence of a chart for a particular Departure, Arrival, or Approach does not preclude its availability or inclusion in the Flight Plan or Procedures portion of the system. The absence of a particular Departure, Arrival, or Approach under the Flight Plan or Procedures portion of the system does not preclude the ability to view the Chart for that procedure under the Chart feature.*



NOTE: *Baro-corrected altitude is not required by the GTN unit to meet the requirements of TSO-C146c; however, to take full advantage of the GTN unit's capabilities, an optional baro-corrected altitude source is recommended for (1) automatic sequencing of altitude leg types, and (2) en route vertical navigation. If the GTN does not receive baro-corrected altitude data, altitude leg types require manual sequencing, and en route vertical navigation is not available.*

Foreword

Getting Started

Audio & Xpdr Ctrl

Com/Nav

FPL

Direct-To

Proc

Charts

Wpt Info

Map

Traffic

Terrain

Weather

Nearest

Services/ Music

Utilities

System

Messages

Symbols

Appendix

6.1 Basic Approach Operations

The GTN 7XX provides lateral and, when appropriate, vertical guidance for visual and GPS/RNAV approaches. The moving map pages can also be used as an aid to situational awareness for ILS, VOR, and NDB approaches (and non-precision localizer-based approaches), but the appropriate radio navigational aid **MUST** be used for primary approach course guidance for non-GPS approaches.

Approaches designed specifically for GPS are often very simple and don't require overflying a VOR or NDB. Currently, many non-precision approaches have "GPS overlays" to let you fly an existing procedure (VOR, VOR/DME, NDB, etc.) more accurately using GPS.

Many overlay approaches are more complex (in comparison to GPS-only approaches). The GTN 7XX displays and guides you through each leg of the approach — automatically sequencing through each of these legs, up to the missed approach point (MAP). Approaches may be flown "as published" with the full transition — using any published feeder route or initial approach fix (IAF) — or may be flown with a vectors-to-final transition.

Phase of flight annunciations are provided on the bottom of the display indicating the current mode of flight.

Procedures are arranged around the existing flight plan in the following order: Departure, En Route, Arrival, and Approach. For example, Departure waypoints are inserted before the En Route waypoints in the flight plan and Arrival waypoints are inserted between the En Route waypoints and the approach waypoints. Always verify that the transition waypoints between each phase are correct.

- Foreword
- Getting Started
- Audio & Xpdr Ctrl
- Com/Nav
- FPL
- Direct-To
- Proc**
- Charts
- Wpt Info
- Map
- Traffic
- Terrain
- Weather
- Nearest
- Services/ Music
- Utilities
- System
- Messages
- Symbols
- Appendix

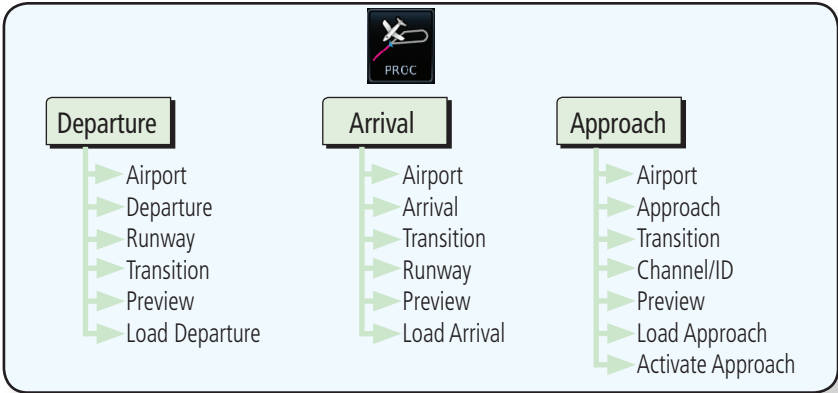

Figure 6-1 Procedures Functional Diagram

Annunciation	Description
LPV	Localizer Performance with Vertical guidance (LPV) approach. Fly to LPV minimums.
LP +V	Localizer Performance using published LP minima. Advisory vertical guidance is provided. Fly to LP minimums.
LP	Localizer Performance with no vertical guidance. Fly to LP minimums.
VISUAL	Advisory visual approach with vertical guidance based on advisory terrain avoidance calculations. CDI scaling is identical to LPV approaches.
L/VNAV	Lateral Navigation and Vertical Navigation (LNAV/VNAV) approach. Fly to LNAV/VNAV minimums.
LNAV+V	GPS approach using published LNAV minima. Advisory vertical guidance is provided. Fly to LNAV minimums.
LNAV	Lateral Navigation approach. Fly to LNAV minimums.
MAPR	Missed Approach indicates the system is providing missed approach integrity and CDI full-scale deflection ± 0.3 NM.
ENR	En route, CDI full-scale deflection is 2.0 NM or current CDI scale selection, whichever is smaller.
TERM	Terminal, CDI full-scale deflection is 1.0 NM or current CDI scale selection, whichever is smaller.
DPRT	Departure, indicates the system is using non-precision approach integrity. CDI full-scale deflection is 0.3 NM.
OCN	Oceanic, CDI full-scale deflection is 2.0 NM.
LOW ALT (lower window)	For LNAV+V, LNAV/VNAV, or LPV approaches, the LOW ALT annunciation indicates the aircraft's estimated height is lower than the Final Approach Waypoint height by approximately 50 meters. This annunciation will not be active when TAWS is operational.

Table 6-1 Phase of Flight Annunciations

6.2 Selecting a Departure

A Departure Procedure (DP) is loaded at the departure airport in the flight plan. Only one departure can be loaded at a time in a flight plan. If a departure is loaded when another departure is already in the active flight plan, the new departure replaces the previous departure. The route is defined by selection of a departure, the transition waypoint, and a runway.



NOTE: *Vector-only departures are not available in the Procedures database as the GTN 7XX cannot provide navigational guidance on vectored legs.*



1. Touch the **PROC** key on the Home page and then touch the **Departure** key to display the Departure list.
2. If necessary, touch the **Airport** key and enter the departure airport. Touch the key for the desired Departure.



Figure 6-2 List for Selecting a Departure



NOTE: *Advisory climb altitudes for SIDs may not match charted altitudes. Do not rely solely on GTN advisory altitudes.*

3. Touch the key for the desired Transition.

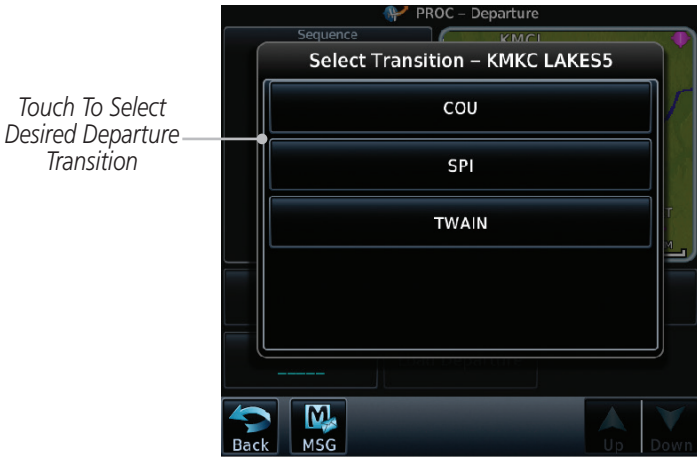

Figure 6-3 Selecting a Transition for a Departure

4. Touch the key for the desired Runway, if necessary. The Departure page with preview will be displayed.



Figure 6-4 Departure Selected



NOTE: If the selected runway is depicted as RW10B, for instance, this means both runways 10L and 10R.

Load Departure

5. Touch the **Load Departure** key. The Active Flight Plan page will be displayed.

Touch To Change Or Remove Departure

Touch To Edit Waypoint



Scroll To View Flight Plan With Departure Waypoints

Figure 6-5 Flight Plan After Loading a Departure

6. Remove a departure or select a new one by touching the Departure key and selecting the desired choice.



Touch To Change A Departure

Touch To Remove Departure

Figure 6-6 Editing a Departure

6.3 Selecting an Arrival

A Standard Terminal Arrival (STAR) can be loaded at any airport with a published arrival procedure. Only one arrival can be loaded at a time in a flight plan. If an arrival is loaded when another arrival is already in the active flight plan, the new arrival replaces the previous arrival. The route is defined by selection of an arrival, the transition waypoint, and a runway.



1. Touch the **PROC** key on the Home page and then touch the **Arrival** key.



Figure 6-7 Arrival Page

2. Confirm that the intended airport is shown or touch the **Airport** key and select the desired arrival. Touch the key for the desired Arrival.

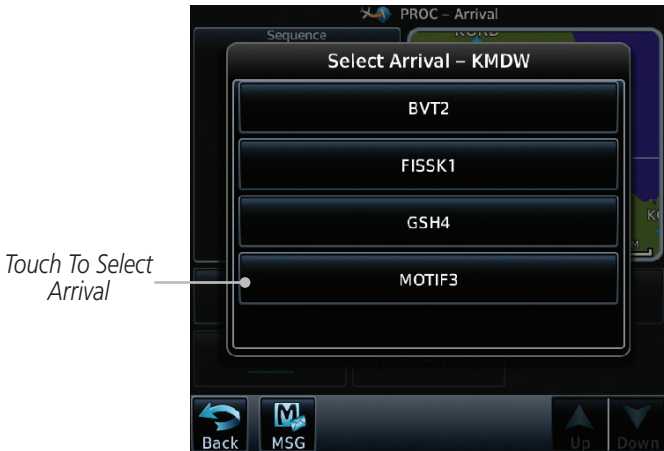

Figure 6-8 Arrival List

3. Touch the **Transition** key and then touch the key for the desired transition.

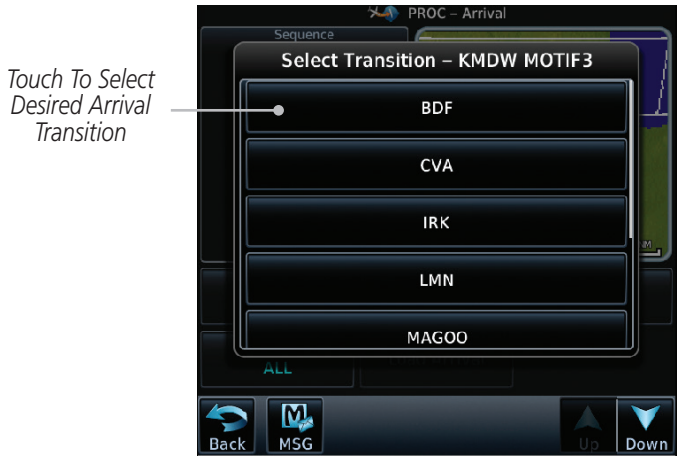

Figure 6-9 Select Transition

4. Touch the key for the desired Runway, if necessary.



NOTE: If the selected runway is depicted as RW10B, for instance, this means both runways 10L and 10R.

5. After selecting the runway, the Arrival page with map preview will be displayed.



Figure 6-10 Previewing an Arrival

Foreword
Getting Started
Audio & Xpdr Ctrl
Com/Nav
FPL
Direct-To
Proc
Charts
Wpt Info
Map
Traffic
Terrain
Weather
Nearest
Services/Music
Utilities
System
Messages
Symbols
Appendix

Load Arrival

6. Touch the **Load Arrival** key. The Active Flight Plan page will be displayed.

Touch To Select Or Remove Arrival

Touch To Edit Waypoint

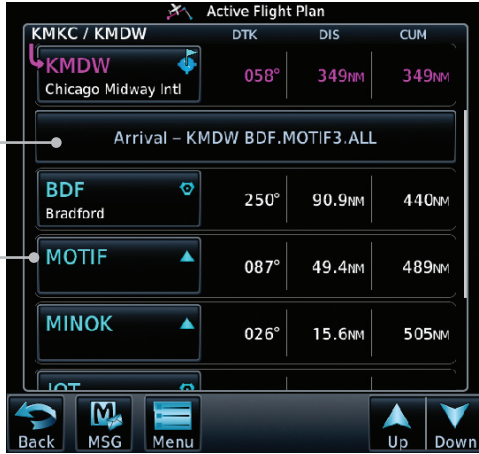

Scroll To View Flight Plan With Departure Waypoints

Figure 6-11 Flight Plan With Arrival Loaded



NOTE: If using Descent VNAV, verify that the altitudes for the selected procedure match the charted altitudes and are appropriate for the airframe type.

6.4 Selecting an Approach



NOTE: In software v6.21 and later, the pilot may load an alternate approach during a missed approach procedure. The GTN retains all missed approaches in the flight plan.

Only one approach can be loaded at a time in a flight plan. If an approach is loaded when another approach is already in the active flight plan, the new approach replaces the previous approach. The route is defined by selection of an approach, the transition waypoint, and a runway.



1. Touch the **PROC** key on the Home page. The Approach, Arrival, and Departure fields will be dashed until a selection is made.

- Proc
- Charts
- Wpt Info
- Map
- Traffic
- Terrain
- Weather
- Nearest
- Services/Music
- Utilities
- System
- Messages
- Symbols
- Appendix

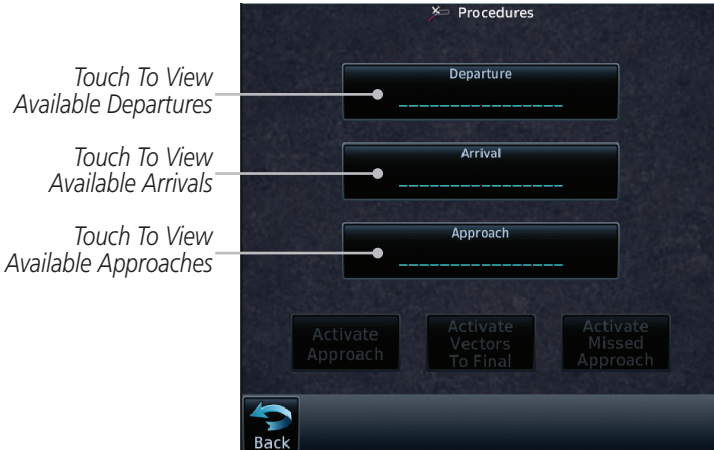
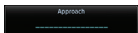

Figure 6-12 Procedures Selection Window



2. Touch the **Approach** key on the Procedures page to select an approach for the destination airport. Confirm that the intended airport is shown or touch the **Airport** key and select the desired airport.



NOTE: If using Descent VNAV, verify that the altitudes for the selected procedure match the charted or ATC cleared altitudes and are appropriate for the airframe type.

3. Touch the **Approach** key on the Procedures-Approach page and then touch the key for the desired approach. Selections are listed according to approach type: instrument first, visual second.

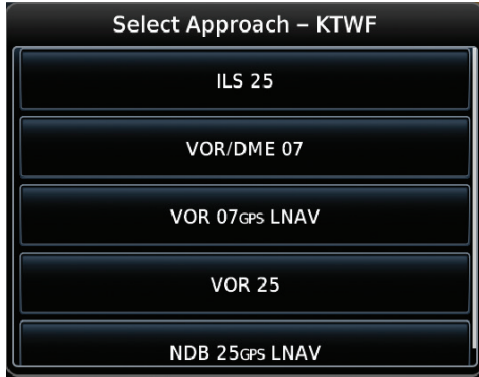

Figure 6-13 Selecting an Approach

4. After selecting the approach for the destination airport, the approach options will be displayed.

Sequence List For The Selected Transition

Sequence	Altitude	Distance
MALTT	0°	0.0 NM
GABBY	277°	17.5 NM
SOREE	277°	4.0 NM
VUPCU	277°	6.2 NM
RW26	277°	5.9 NM
4700 FT	276°	1.0 NM
UYEME	317°	15.9 NM
Hold	136°	0.0 NM

PROC - Approach

Airport: KTFW

Approach: RNAV 26 Gps LPV

Transition: Vectors

Channel / ID: 56311 W26A

Buttons: Load Approach, Load Approach & Activate

Callouts:

- Final Approach Fix
- Missed Approach Point
- Missed Approach Hold Point
- Current Dest Waypoint. Touch To Select Approach.
- Touch To Select Channel/ID
- Touch To Select Approach
- Touch To Load Approach
- Unselected Transition
- Selected Transition
- Approach Diagram
- Touch To Select Transition
- Touch To Activate Approach

Figure 6-14 Selected Approach Options

Foreword
Getting Started
Audio & Xpdr Ctrl
Com/Nav
FPL
Direct-To
Proc
Charts
Wpt Info
Map
Traffic
Terrain
Weather
Nearest
Services/Music
Utilities
System
Messages
Symbols
Appendix

Transition
Vectors

5. Touch the **Transition** key and then touch the key for the desired transition. The selected Transition will be shown in white on the Procedure page Approach diagram. Unselected Transitions will be shown in gray.

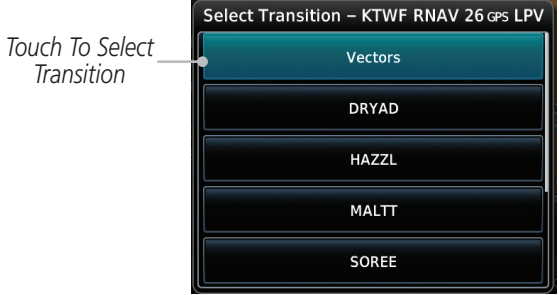

Figure 6-15 Select Approach Transition

Channel / ID
40017 W10A

6. If desired, touch the **Channel/ID** key, then use the numeric keypad to select the channel number, and then touch the Enter key. The Channel and ID are typically loaded automatically if they are present.



NOTE: As an alternate means of loading an approach, the Channel ID key allows you to select the channel ID for a SBAS approach for the current destination. The channel ID for the SBAS approach is available from an approved approach chart. If duplicate numbers are available for a channel, a list will be available where you may select the desired approach.

Load
Approach

7. Touch the **Load Approach** key. The Active Flight Plan page will be displayed. The approach waypoints are placed at the end of the flight plan and the unit will automatically sequence to them after the en route waypoints.

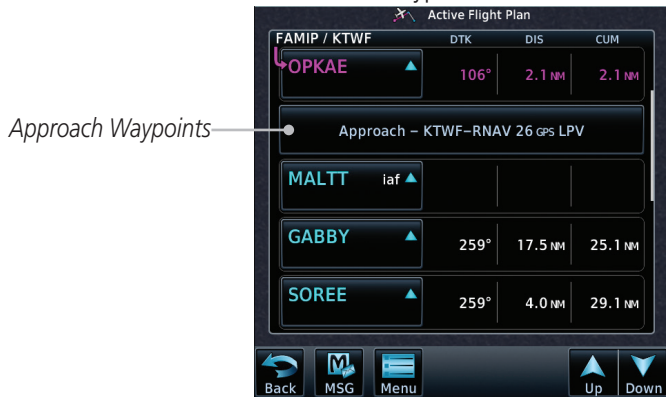

Figure 6-16 After Loading an Approach

v5.13 and Earlier or v6.50 and Later	v6.00 Through v6.41
<p>If you build your flight plan with the destination airport at the end and then load an approach procedure, you will navigate all the way to the destination airport before joining the procedure. Be sure when LOADING and not ACTIVATING an approach procedure that the route to be flown is correct.</p>	<p>If you build your flight plan with the destination airport at the end and then load an approach procedure, the destination airport will be removed from the end of the flight plan. If the leg to the destination airport is the active leg when loading an approach procedure, you will navigate all the way to the destination airport before joining the procedure. Be sure when LOADING and not ACTIVATING an approach procedure that the route to be flown is correct.</p>

Table 6-2 Loading and Activating an Approach



8. Touch the **Load Approach & Activate** key, which makes the active leg Direct-To the selected transition waypoint, or for Vector approaches to activate a leg that is an extended final approach course. You can also “activate” the selected procedure on the Procedures page, if the approach is not activated on this page.

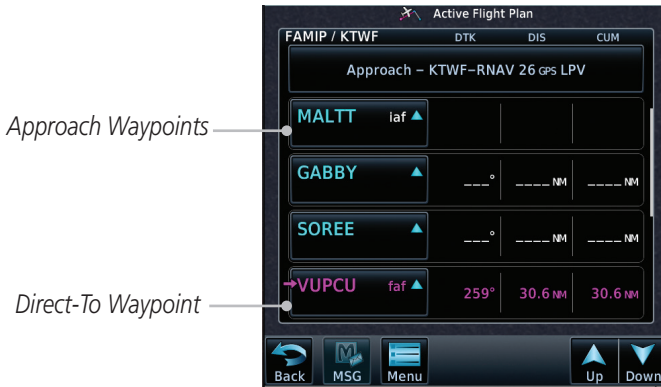

Figure 6-17 After Activating the Approach



NOTE: When re-activating an approach, the decision as to whether a hold is inserted at the IAF or not is assumed to be the same as the first time the approach was activated, regardless of current aircraft position. If the pilot wishes to have the hold inserted or removed from the procedure, the procedure must be re-loaded or activated from the PROC-Approach page.

6.5 Approaches with Procedure Turns

The procedure turn portion of an approach is stored as one of the legs of the approach. For this reason, the GTN 7XX unit requires no special operations from the pilot — other than flying the procedure turn itself — beyond what is required for any other type of approach. Roll steering is provided to aircraft with compatible autopilots.



NOTE: *The steering provided for the procedure turn does not guarantee that the aircraft will stay within charted procedure turn boundaries. As such the crew will need to ensure that the approach is flown within the confines of the charted procedure.*

6.6 Flying the Missed Approach

Upon reaching the Missed Approach Point, the GTN 7XX unit continues to give guidance along an extension of the final course segment (FAF to MAP) until you manually initiate the missed approach procedure (as mentioned previously in reference to the “SUSP” advisory).



NOTE: *If the unit is not configured for a CDI key, then the “activate GPS missed approach” will only resume automatic waypoint sequencing. The user must switch to GPS navigation, if desired, by using their external source selection method (this is typical an EFIS system).*

1. When the MAP is reached, a pop-up will appear.



Figure 6-18 Pop-Up Upon Reaching the MAP

2. Touch the **Remain Suspended** key to continue with sequencing suspended or touch **Activate GPS Missed Approach** for guidance to the Missed Approach Hold Point.

The Activate GPS Missed Approach function is the same for the on screen controls or a remote switch. Activating the missed approach prior to the MAP can be accomplished on either the Flight Plan or Procedures pages. If using the Flight Plan page, the approach banner must be touched to display the Approach Options where Activate Missed Approach can be selected.

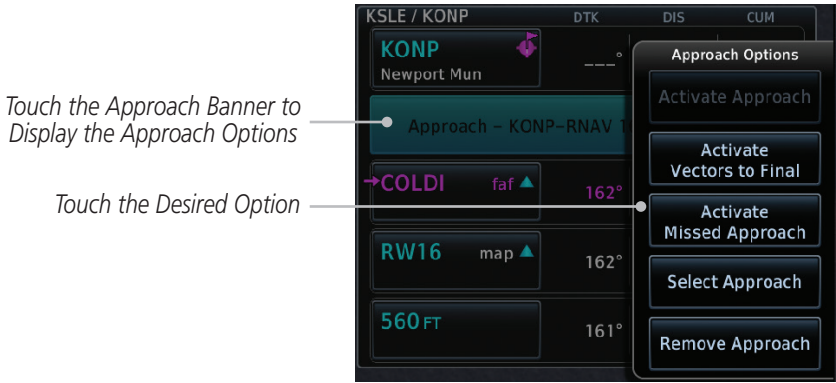

Touch the Approach Banner to Display the Approach Options

Touch the Desired Option

Figure 6-19 Approach Option Selection on the Flight Plan Page



Touch the Approach Banner to Display the Approach Options

Touch the Desired Option

Figure 6-20 Approach Option Selection on the Procedures Page

Once an option is selected, the GTN will continue to provide guidance along the final approach course. Upon reaching the MAP, the unit will automatically sequence to the first leg of the missed approach. This is used when a pilot needs to execute the missed approach prior to reaching the MAP.

6.7 Flying an Approach with a Hold

Upon activating an RNAV GPS approach, you are given the option to skip any non-required holding patterns during the initial transitions of the approach.

The Flight Plan Page displays a timer or distance, as appropriate, during the holding pattern. Use this timer or distance to fly the outbound portion of the holding pattern. (The holding pattern is displayed on the Map Page and indicated as the active leg on the Active Flight Plan pages.)



NOTE: If you need to lose extra altitude or speed by going around the holding pattern again, touch **SUSP** to manually suspend waypoint sequencing BEFORE crossing the holding waypoint the second time. If you've already passed this waypoint, re-activate the holding pattern.

As you cross the MAP, a "SUSP" annunciation will appear, indicating that automatic sequencing of approach waypoints is suspended at the MAP. A "from" indication is displayed on the CDI and Default NAV Page, but course guidance along the final approach course continues.

6.8 Flying a DME Arc Approach

Approaches that contain DME arcs are supported by the GTN. The GTN will provide guidance (left / right) relative to the arc. If you wish to activate the DME arc leg manually, the aircraft must be near the arc, as shown in the shaded area below.

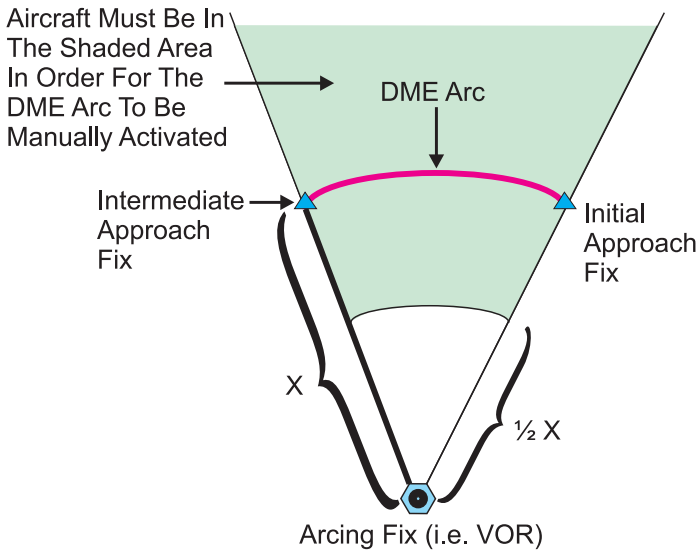

Figure 6-21 DME Arc Example

6.9 Radius-to-Fix (RF) Approaches

RF legs associated with RNAV RNP 1.0 non-AR (Approval Required) approaches are supported by the GTN in version 6.00, or later, when approved by the installation.

- AC 90-101A defines RF leg as "a constant radius circular path, around a defined turn center, that starts and terminates at a fix. An RF leg may be published as part of a procedure."
- Flying the RF leg of an approach is similar to flying a DME arc approach. All GTN annunciations and indications are identical whether flying DME arcs or RF legs with the GTN.
- RF legs may have a larger or smaller radius than DME arcs.
- Unlike DME arcs, RF legs are not based on a VOR.
- Refer to the aircraft AFMS for specific details regarding RF legs for a specific aircraft.

6.10 Vectors to Final

With “Vectors-To-Final” (VTF) selected, the CDI needle remains off center until you’re established on the final approach course. With the approach activated, the Map Page displays an extension of the final approach course in magenta (remember, magenta is used to depict the active leg of the flight plan) and “vtf” appears as part of the active leg on the Map page (as a reminder that the approach was activated with vectors-to-final).



NOTE: In software v5.13 and earlier, once VTF is activated all waypoints in the approach prior to the FAF are removed.



NOTE: In software v6.00 and later, all waypoints along the final approach course, including waypoints before the FAF, are included in the flight plan and the final approach course to the FAF is activated.

6.11 ILS Approaches (GTN 750 Only)

Precision ILS approaches can be performed with the built-in VLOC (VOR/localizer/glideslope) receivers. The GPS receiver can be used for guidance prior to reaching the final approach fix, but once there, the proper frequency must be selected on the VLOC window (right side of screen) and the CDI output set to “VLOC.”

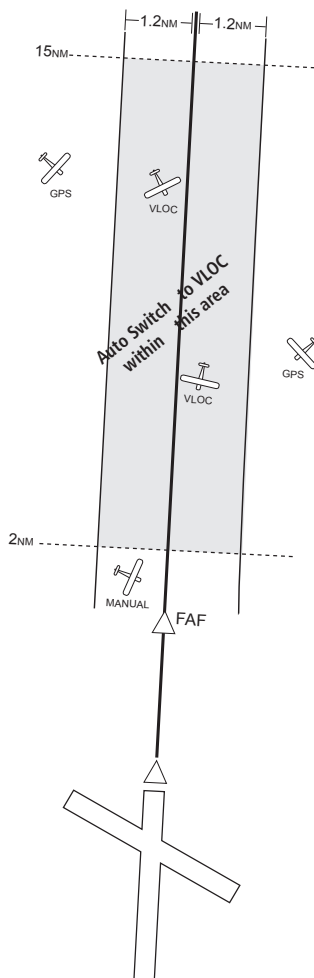

The GTN 7XX can be set to automatically switch the external CDI output from GPS to VLOC as you intercept the final approach course (if used with a KAP140/KFC225 autopilot, you will need to manually enable outputs. See instructions in the “Enabling Autopilot Outputs for the King KAP140/KFC225” section). When the ILS approach is activated and the correct ILS frequency is active in the VLOC window, the GTN 7XX automatically switches to VLOC within 1.2 NM left or right of the final approach course. This switch can take place anywhere from 2.0 to 15.0 NM from the FAF.

The illustration shows multiple locations along the approach path and the CDI selection that you can expect: GPS or VLOC. Within the area of the shaded box, the automatic switch from GPS to VLOC should occur.

NOTE: If you attempt to intercept the approach course at a distance less than 2.0 NM from the FAF, the GTN 7XX does not automatically switch the CDI to VLOC. In this case, touch the **CDI** key to manually switch from GPS to VLOC.



The automatic switch from GPS to VLOC is not immediate, but instead occurs gradually to prevent abrupt CDI changes when coupled to an autopilot. The CDI selection can also be changed manually by touching the **CDI** key.

6.12 RNAV Approach Procedures

The GTN 7XX allows for flying LNAV/VNAV, LNAV, LNAV +V, LPV, LP, and LP +V approaches according to the published chart.

Phase of flight Annunciation	Description	Minimums
L/VNAV	Lateral Navigation/Vertical Navigation. RNAV non-precision approach with vertical guidance.	Published LNAV/VNAV minimums.
LNAV	Lateral Navigation. RNAV non-precision approach.	Published LNAV minimums.
LNAV + V	Lateral Navigation with Advisory Vertical Guidance. RNAV non-precision LNAV approach with advisory vertical guidance. The glidepath is typically denoted by a light dashed line on the vertical profile (Jeppesen only) with an associated glidepath angle (usually in the 3.00 degree range) and is provided to assist the pilot in maintaining a constant vertical glidepath, similar to an ILS glide slope.	Published LNAV minimums.
LPV	Localizer Performance with Vertical guidance (LPV) approach. RNAV precision approach.	Published LPV minimums.
LP	LP indicates Localizer Performance with no vertical guidance.	Published LP minimums.
LP +V	LP +V indicates Localizer Performance with advisory vertical guidance. This annunciation is available in software v6.00 and later. This advisory guidance follows the same nature as set by the LNAV +V as shown above.	Published LP minimums.

Table 6-3 RNAV Approach Annunciations

Foreword

Getting Started

Audio & Xpdr Ctrl

Com/Nav

FPL

Direct-To

Proc

Charts

Wpt Info

Map

Traffic

Terrain

Weather

Nearest

Services/ Music

Utilities

System

Messages

Symbols

Appendix

6.12.1 Flying the LPV Approach

1. Within 31 NM of the destination, the GTN switches from en route mode to terminal mode and the CDI scale transitions from 2.0 to 1.0 NM, full scale deflection.
2. As you approach the IAF, a waypoint message appears on the bottom of the screen.
3. As the distance (DIST) to the IAF approaches zero, the message is replaced by a turn advisory that counts down 10 seconds prior to the turn.
4. As you approach the FAF, the GTN will begin to automatically rescale in an angular fashion. This will allow the LPV approach to be flown in an identical fashion to a standard ILS. At 2.0 NM from the FAF, CDI scaling is tightened from 1.0 NM to the angular full scale deflection (typically the angular full-scale deflection is 2.0°, but will be as defined for the approach).
5. Sixty seconds prior to reaching the FAF, the unit will check the required Horizontal Alarm Limit (HAL) and Vertical Alarm Limit (VAL) to ensure the GPS position integrity is within limits to complete the LPV precision approach. In the event the HAL or VAL limits are exceeded, the approach will be downgraded to a non-precision approach indicated by "LNAV" on the moving map, a message that the approach is downgraded ("APPROACH DOWNGRADE - GPS approach downgraded. Use LNAV minima."), and the glideslope indicator will be flagged. You may continue the approach using LNAV non-precision minimums if there are LNAV minimums for this approach. In the rare event the GPS integrity cannot meet the non-precision HAL limits, the unit will send a message to the pilot to abort the approach ("ABORT APPROACH - GPS approach no longer available."). The unit will revert to terminal limits to support navigation to the missed approach when the message is acknowledged. After the aircraft has passed the FAF, a loss of WAAS integrity will cause the approach to abort instead of downgrade.
6. Capture the glideslope as you would an ILS glideslope.

7. As you cross the FAF, the destination sequences to the MAP (e.g., "RW31," the runway threshold). With the needle on the external CDI (or HSI) centered, fly toward the MAP, observing the altitude minimums published on the approach plate.
8. When viewing the Map Page, you'll note that the final course segment is displayed in magenta (the active leg of the flight plan always appears in magenta).
9. As you approach the MAP, a waypoint message appears on the bottom of the screen.
10. Once the unit crosses the MAP (defined as the runway end waypoint), sequencing will be suspended. Prepare the aircraft for missed approach operation. Touch the **Unsuspend** key to sequence to the Missed Approach procedure.
11. Fly the guidance provided by the unit to the MAHP and hold.

6.12.2 Flying the LP Approach

An LP approach is flown similarly to an LNAV approach, except the precision is greater as it utilizes the SBAS accuracy. It has similar lateral accuracy as an LPV approach. Angular scaling is similar to a localizer approach. Most LP approaches have step down altitudes associated with them. The approach still results in an MDA and missed approach point.

If the approach is indicated as LP +V, advisory vertical guidance will be provided. This does not change how the approach should be flown, and the pilot is still responsible for descending to the correct altitude at each step down. The approach still results in an MDA and missed approach point.

1. Within 30 NM of the destination, the GTN switches from en route mode to terminal mode and the CDI scale transitions from 2.0 to 1.0 NM, full scale deflection.
2. As you approach the IAF, a turn direction message appears on the bottom of the screen.
3. As the distance (DIST) to the IAF approaches zero, the message is replaced by a time to turn advisory that counts down 10 seconds prior to the turn.
4. As you approach the FAF, the GTN will begin to automatically rescale in an angular fashion. This will allow the LP approach to be flown in the same fashion as a standard localizer approach. At 2.0 NM from the FAF, CDI scaling is tightened from up to either 2° or 0.3 NM, full scale deflection, whichever is smaller.

Foreword

Getting Started

Audio & Xpdr Ctrl

Com/Nav

FPL

Direct-To

Proc

Charts

Wpt Info

Map

Traffic

Terrain

Weather

Nearest

Services/ Music

Utilities

System

Messages

Symbols

Appendix

- Foreword
- Getting Started
- Audio & Xpdr Ctrl
- Com/Nav
- FPL
- Direct-To
- Proc**
- Charts
- Wpt Info
- Map
- Traffic
- Terrain
- Weather
- Nearest
- Services/
Music
- Utilities
- System
- Messages
- Symbols
- Appendix
- Index

5. Sixty seconds prior to reaching the FAF, the GTN will check the required Horizontal Alarm Limit (HAL) to ensure the GPS position integrity is within limits to complete the LP non-precision approach. In the event the HAL limits are exceeded, the approach will be downgraded, when available, indicated by “LNAV” on the moving map, otherwise the approach will be aborted. A message will note that the approach is downgraded and the NAV indicator will be flagged until the message is viewed. You may continue the approach using LNAV non-precision minimums if there are LNAV minimums for this approach. In the rare event the GPS HAL limits cannot meet non-precision limits, the GTN will notify the pilot with a message to abort the approach. The GTN will revert to terminal limits of 1.0 NM to support navigation to the missed approach. If the approach is indicating an LP +V, it is possible that the advisory vertical guidance could be removed without annunciation due to the vertical guidance not being within tolerances. This does not constitute a downgrade, and the approach can still be flown to LP minimums.
6. As you cross the FAF, the destination sequences to the MAP. With the needle on the external CDI (or HSI) centered, fly toward the MAP, observing the altitude minimums published on the approach plate.
7. When viewing the Map Page, you’ll note that the final course segment is displayed in magenta (the active leg of the flight plan always appears in magenta).
8. As you approach the MAP, a waypoint message (“Arriving at Waypoint”) appears on the bottom of the screen.
9. At the MAP initiate the missed approach, if necessary. Once the GTN crosses the MAP, sequencing will be suspended. Prepare the aircraft for missed approach operation. Touch the **Unsuspend** key to sequence to the Missed Approach procedure.



NOTE: For missed approaches with heading legs, fly manually until the first active course leg is reached.

10. Fly the guidance provided by the GTN to the MAHP and hold.

6.13 Visual Approach Procedures



NOTE: This feature is available in software v6.30 and later. Not all airports in the database support visual approaches.

The GTN generates visual approaches, providing advisory horizontal and optional vertical guidance for the selected runway. Advisory guidance aids in the performance of a stabilized approach and ensures the aircraft is in line with the destination runway.

There are three different methods for loading and activating visual approaches.

Method 1: Select the **Visual** key on the map. When the aircraft is within 10 NM of the destination airport the **Visual** key displays. For information about key configuration, refer to "Visual Approach Selector".



Figure 6-22 Visual Approach Key - No Selected Destination

Foreword

Getting Started

Audio & Xpdr Ctrl

Com/Nav

FPL

Direct-To

Proc

Charts

Wpt Info

Map

Traffic

Terrain

Weather

Nearest

Services/
Music

Utilities

System

Messages

Symbols

Appendix

Method 2: Select the **Visual** key located on the bottom edge of the screen. This key displays when a visual approach supported airport is selected on the map during pan mode.

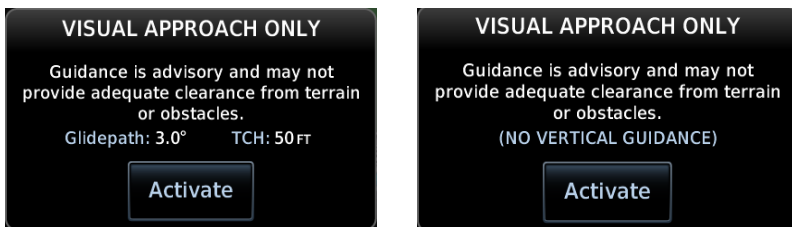

Figure 6-23 Visual Approach Key - Selected Destination

For both methods, pressing the **Visual** key prompts a list of available visual approaches. Once selected, the visual approach immediately loads and becomes active.

Method 3: Visual approaches load from the PROC - Approach page or the Airport Info - Procedures tab (similar to published instrument approaches). For information on how to use this page, refer to section 6.4.

After a visual approach loads, a confirmation pop-up prompts, detailing the glidepath angle (GPA) and threshold crossing height (TCH) when vertical guidance is available. When unavailable it reads, "NO VERTICAL GUIDANCE."



Vertical Guidance Available

Vertical Guidance Unavailable

Figure 6-24 Visual Approach Confirmation Pop-up

The availability of vertical guidance advisories for visual approaches is dependent on terrain and obstacle obstructions along the approach path. If no known obstructions are within the approach path, vertical guidance is provided to a maximum distance of 28 NM from the runway. If there are known obstructions further than 3 NM, but within the 28 NM maximum distance from the runway along the approach, vertical guidance is limited to the approach path portion after crossing the known obstructions. This is indicated by the shortened magenta line on the map after loading the approach. If obstructions are within 3 NM to the runway, along the approach path, advisory vertical guidance is not provided. Lateral guidance is always provided for visual approaches.

Published data is used to determine the visual approach GPA and TCH for the selected runway. If no published data is available, the default is 3° GPA and 50 FT TCH.



NOTE: *If the GTN does not have a valid terrain database, advisory vertical guidance is not available for visual approaches.*



NOTE: *Only external CDI/VDI displays provide vertical deviation indications.*

Foreword

Getting Started

Audio & Xpdr Ctrl

Com/Nav

FPL

Direct-To

Proc

Charts

Wpt Info

Map

Traffic

Terrain

Weather

Nearest

Services/ Music

Utilities

System

Messages

Symbols

Appendix

6.14 Points to Remember for All Procedures

- Foreword
- Getting Started
- Audio & Xpdr Ctrl
- Com/Nav
- FPL
- Direct-To
- Proc**
- Charts
- Wpt Info
- Map
- Traffic
- Terrain
- Weather
- Nearest
- Services/ Music
- Utilities
- System
- Messages
- Symbols
- Appendix

- The GTN 7XX Map page is designed to complement your approach plates and vastly improve situational awareness throughout the approach. However, *you must always fly an approach as it appears on the approach plate.*
- The active leg (or the portion of the approach currently in use) is depicted in magenta on the Map Page. As you fly the approach, the GTN 7XX automatically sequences through each leg of the approach unless “SUSP” appears at the annunciation bar at the bottom of the display. “SUSP” indicates that automatic sequencing of approach waypoints is suspended on the current leg and normally appears at holding patterns, upon crossing the missed approach point (MAP), for Climb to Altitude legs, and for Hold to Altitude legs.
- For roll steering autopilots: roll steering is terminated when approach mode is selected on the autopilot and is available once the missed approach is initiated.
- If Vectors-to-Final is activated while on the “FROM” side of the FAF, automatic waypoint sequencing is suspended and the SUSP annunciation will appear. Automatic waypoint sequencing will resume once the aircraft is on the “TO” side of the FAF and within full-scale deflection.
- For all procedures, make sure to check the runway, transition, and all waypoints.
- Most legs are “TO” legs on which the TO/FROM flag on the CDI indicates “TO” and the Distance field on the flight plan decreases as you navigate along the leg. However, some procedures include legs which are “FROM” legs. On these legs, the TO/FROM flag on the CDI indicates “FROM” and the Distance field on the flight plan increases as you navigate the leg. “FROM” legs are typically found on procedure turns and on some missed approach procedures.



CAUTION: *Not all autopilots will follow guidance when on a heading leg using NAV, GPSS, or APR mode on the autopilot. Heading legs for procedures can be identified by “HDG XXX°” in white on the Flight Plan page, as well as the procedure chart indicating that the aircraft must fly a particular heading. Certain autopilots will revert to a “Roll Only” or “Wings Level” mode on these leg types and the pilot must engage the heading (HDG) mode of the autopilot and set the heading bug appropriately in order to use the autopilot on these legs.*

6.15 Points to Remember for Localizer or VOR-based Approaches

- The default factory setting allows the CDI output to automatically switch from the GPS receiver to the LOC receiver. This may be changed to manual in some installations. If the “ILS CDI Selection” setting is changed to “Manual,” you must determine when to select “GPS” or “VLOC” guidance during the approach. Remember, “VLOC” is required for the final course segment from the Final Approach Fix (FAF) to the MAP.



NOTE: Installations with certain autopilots, such as the KAP 140 and KFC225, do not allow automatic ILS CDI switching.



NOTE: GPS phase of flight annunciations (LPV, ENR, etc.) are not applicable to the external CDI (or HSI) when VLOC is active.

- If the CDI output has not automatically switched from GPS to ILS upon reaching the FAF, you must manually switch to the VLOC receiver by touching the **CDI** key. Verify that “VLOC” is displayed.
- Automatic switching of CDI output is available for ILS, localizer, SDF and LDA approaches. Automatic CDI switching is not available for backcourse approaches or VOR approaches.
- When flying an approach with the autopilot-coupled, you must monitor system functions at all times and verify that the autopilot and external CDI (or HSI) switch to the VLOC receiver with sufficient time to capture and track the approach course. Switching to “VLOC” late in the approach may not provide the autopilot enough time to respond and intercept the approach course prior to the FAF (depending upon the performance characteristics of your autopilot and aircraft).
- When an ILS or VOR approach is first selected or executed, the frequency is automatically checked. If the frequency is incorrect, you will receive a message and you must place the correct ILS or VLOC frequency in the active frequency field.

- Foreword
- Getting Started
- Audio & Xpdr Ctrl
- Com/Nav
- FPL
- Direct-To
- Proc**
- Charts
- Wpt Info
- Map
- Traffic
- Terrain
- Weather
- Nearest
- Services/ Music
- Utilities
- System
- Messages
- Symbols
- Appendix

- When flying a localizer-based approach (other than backcourse) with automatic CDI switching enabled:



1. "GPS" guidance may be used while flying outbound and on the initial portion of the procedure turn.
2. "VLOC" guidance is used on the remainder of the approach from the time you turn inbound on the procedure turn.
3. The localizer frequency must be active to use "VLOC" guidance at the MAP.

- When flying a localizer-based approach with automatic CDI switching disabled:

1. You may select "VLOC" guidance at any point on the approach prior to reaching the FAF.
2. The localizer frequency must be active to use "VLOC" guidance.

6.16 Enabling Autopilot Outputs for the King KAP140/KFC225

Autopilot outputs for the King KAP140/KFC225 autopilots are activated manually by the pilot after being prompted during the approach procedure. After enabling outputs, the GTN 7XX will provide guidance information consistent with what the autopilot expects (i.e., angular CDI scaling and glideslope capture for an LPV or other vertically guided GPS approach).



Figure 6-25 Prompt To Activate Autopilot Outputs

Foreword

Getting
Started

Audio &
Xpdr Ctrl

Com/Nav

FPL

Direct-To

Proc

Charts

Wpt Info

Map

This page intentionally left blank

Traffic

Terrain

Weather

Nearest

Services/
Music

Utilities

System

Messages

Symbols

Appendix



NOTE: The availability of SafeTaxi, ChartView, or FliteCharts in electronic form may not preclude the requirement to carry paper charts aboard the aircraft. See the AFMS for more information.



NOTE: The Chart feature provides a digital representation of a paper chart and provides no vertical or lateral course guidance. Flight Plan and Procedures are separate from Charts, and do provide vertical and lateral course guidance for the loaded route or procedure shown on the Flight Plan page. The term “Chart Unavailable” means that the chart cannot be viewed on the Charts due to either a chart not being published, or an error in the Chart database, but does not preclude its availability or inclusion of the procedure in the Flight Plan or Procedures portion of the system. The absence of a chart for a particular Departure, Arrival, or Approach does not preclude its availability or inclusion in the Flight Plan or Procedures portion of the system. The absence of a particular Departure, Arrival, or Approach under the Flight Plan or Procedures portion of the system does not preclude the ability to view the Chart for that procedure under the Chart feature.



NOTE: Features that are selectable on the main map page, such as obstacles, airports, airspace, and other waypoint types that are not visible beneath the overlaid chart, remain selectable even when an approach chart is overlaid on the main map.



NOTE: Do not use SafeTaxi or Chartview functions as the basis for ground maneuvering. SafeTaxi and Chartview do not comply with the requirements of AC 120-76C and are not qualified to be used as an airport moving map display (AMMD). SafeTaxi and Chartview should only be used by the flight crew to orient themselves on the airport surface.

The chart page will default to the nearest airport if no flight plan or destination airport is present. While you are on the ground, the displayed charts will default to the current airport location regardless of flight plan. The optional ChartView and FliteCharts provide on-board electronic terminal procedures charts. Electronic charts offer the convenience of rapid access to essential information. Either ChartView or FliteCharts may be configured in the system, but not both.

ChartView resembles the paper version of Jeppesen terminal procedures charts. The charts are displayed in full color with high-resolution. The Map depiction shows the aircraft position on the moving map in the plan view of approach charts and on airport diagrams. Airport Hot Spots are outlined in magenta. The ChartView database subscription is available from Jeppesen, Inc. Available data includes:

- Arrivals (STAR)
- Airport Diagrams
- Approaches
- Departure Procedures (DP)
- NOTAMs

An enablement card that is purchased from Garmin is separate from the Jeppesen database and is required to enable ChartView.



NOTE: The chart for the destination airport or loaded approach will automatically be selected.



NOTE: If two GTN 7XX units are crossfilled, then the same type (ChartView or FlightCharts) and version (cycle number and effective dates) for the chart database must be installed on both units in order for the correct chart to be overlaid on the main map page.

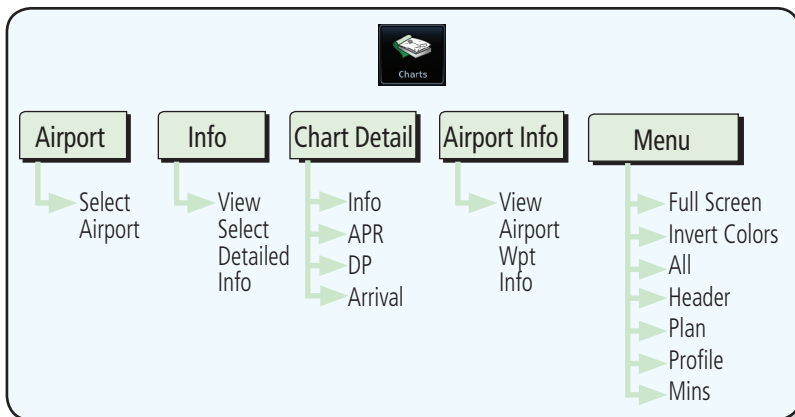

Figure 7-1 Charts Functional Diagram

The following list describes the order in priority in which charts are auto-loaded in the system when the Chart page is displayed:

1. The most-recently selected chart during the current power cycle, if valid*.
2. The airport surface chart for the nearest airport, if on ground and nearest airport is found.
3. The approach chart for the approach in the active flight plan, if approach exists in the flight plan.

4. The airport surface chart for the last airport in the flight plan, if one exists.
 5. The airport surface chart for the nearest airport, if nearest airport is found (same as #2 but aircraft could be in-air).
 6. The airport surface chart for the first airport in the database, if found.
 7. No chart.
- * “Selected” does not include charts that were auto-selected. A selection must be made while on the charts page.

The following actions will invalidate #1:

- Changing the approach in the active flight plan
- Changing the on-ground status while not viewing the Charts page

7.1 Chart Page

1. From the Home page, touch the **Charts** key.



Touch to Select Airport

Touch to Select Airport Info Chart

Touch to View The Airport Information Chart

Touch to View Airport Approach, Departure, & Arrival Charts

Touch to View Airport Wpt Info

Touch To Change Chart Scale

Touch For Full Display View Of Chart

Figure 7-2 Charts Function Page

2. Various controls allow viewing of more available detail.

7.1.1 Airport Selection

1. Touch the **Airport** selection key to select another airport.
2. Select the desired airport identifier with the keypad and touch **Enter**.

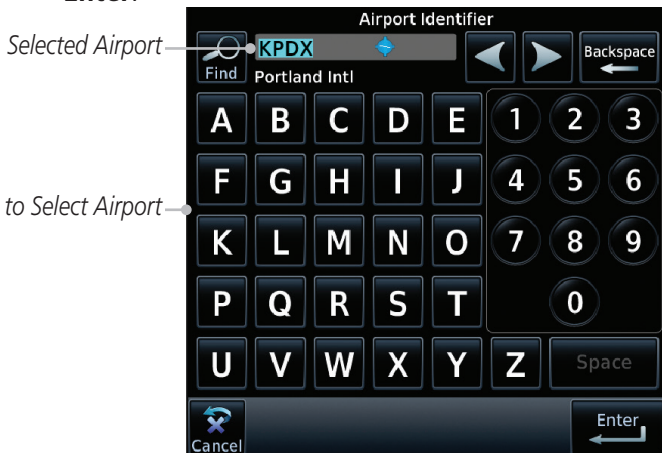
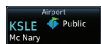

Figure 7-3 Airport Identifier Selection

- Foreword
- Getting Started
- Audio & Xpdr Ctrl
- Com/Nav
- FPL
- Direct-To
- Proc
- Charts**
- Wpt Info
- Map
- Traffic
- Terrain
- Weather
- Nearest
- Services/ Music
- Utilities
- System
- Messages
- Symbols
- Appendix
- Index

7.1.2 Info



1. Touch the **Info** key to select the specific information chart.



Touch To View Selected Airport Info

Figure 7-4 Airport Info Selection

2. Touch an item from the list to view the chart.



Selected Airport

Touch To View Selected Airport Info List

Detailed View Of Selected Airport Info

Figure 7-5 Airport Info Selection Detail

7.1.3 Information



1. Touch the **Information** key.
2. View the available airport information charts.

7.1.4 Approaches

1. Touch the **Approaches** key to view available approaches.



Selected Airport

Touch To View Approach List

Touch To View Approach Charts

Detailed View Of Selected Approach

Figure 7-6 Approach Detail

2. Touch the **Approach** key to select an approach chart.

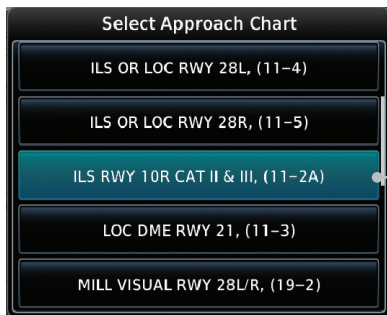

Touch To View Approach Chart

Figure 7-7 Approach List

3. Touch the desired approach to view detailed information.

7.1.5 Departures



1. Touch the **Departures** key to view available departures.

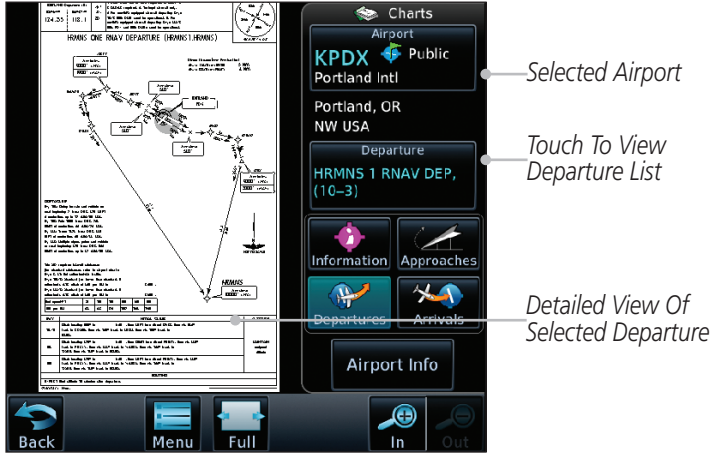

Figure 7-8 Departure Detail



2. Touch the **Departure** key to change the selected Departure chart.

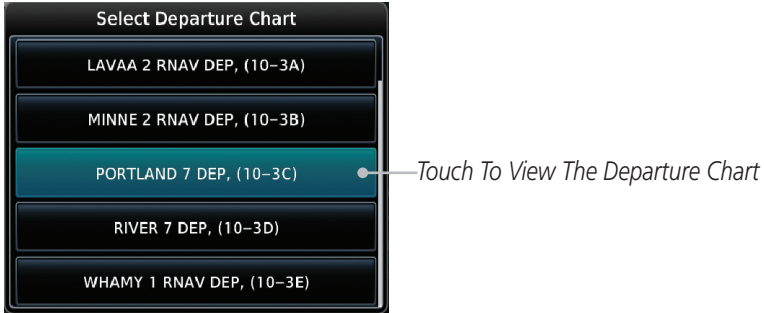

Figure 7-9 Departure List

3. Touch the desired departure to view detailed information.

Foreword

Getting Started

Audio & Xpdr Ctrl

Com/Nav

FPL

Direct-To

Proc

Charts

Wpt Info

Map

Traffic

Terrain

Weather

Nearest

Services/ Music

Utilities

System

Messages

Symbols

Appendix

7.1.6 Arrivals



1. Touch the **Arrivals** key to view available arrivals.



Figure 7-10 Arrival Detail

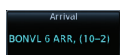

2. Touch the **Arrival** key to change the selected Arrival chart.

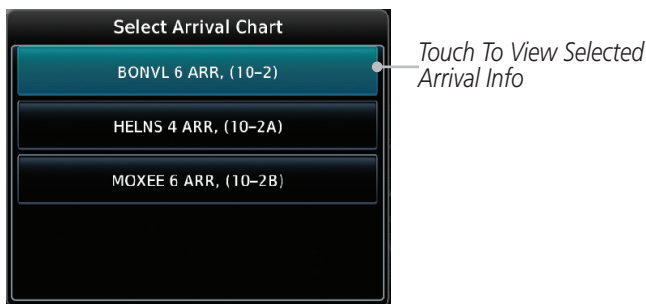

Figure 7-11 Arrival List

3. Touch the desired arrival to view detailed information.

7.1.7 Airport Info



1. Touch the Airport Info key to view the Waypoint Info for the selected airport.

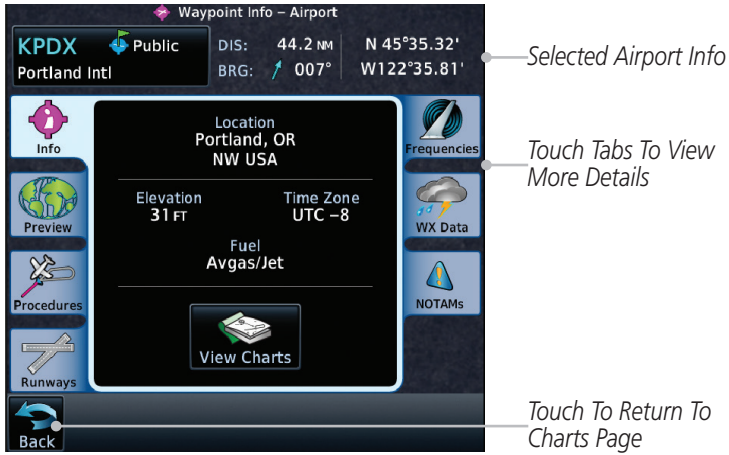

Figure 7-12 Selected Airport Detail



2. Touch the **Back** key to return to the Charts page.

7.1.8 Full/Split Screen



1. Touch the **Full** key to display a full screen view of the current chart page.

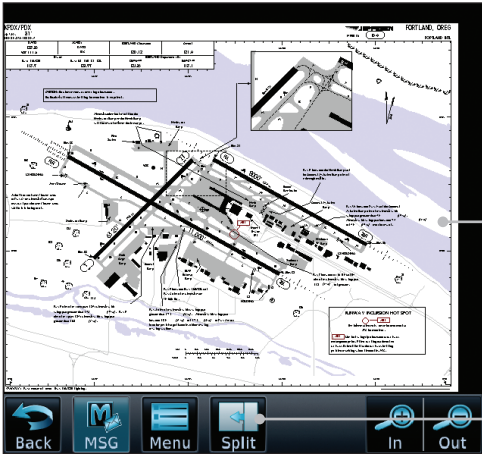

Full Chart Page View

Touch To Return To Split Chart Page View

Figure 7-13 Full View of Chart Page



2. Touch the **Split** key to display a view of the current chart page split between the chart detail and chart page controls.



Split Chart Page View

Touch To Display Full Chart Page View

Figure 7-14 Split View of Chart Page

7.2 Chart Menu Options

Foreword

Getting Started

Audio & Xpdr Ctrl

Com/Nav

FPL

Direct-To

Proc

Charts

Wpt Info

Map

Traffic

Terrain

Weather

Nearest

Services/
Music

Utilities

System

Messages

Symbols

Appendix

Index



1. From the Charts page, touch the **Menu** key.

Touch To Select Chart Layer

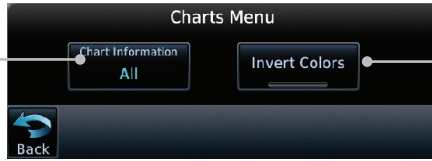

Touch To Display Normal Or Inverted Chart Colors

Figure 7-15 Chart Options



2. Touch the **Chart Information** key to select a Chart Layer. Chart Layers are only available with ChartView.

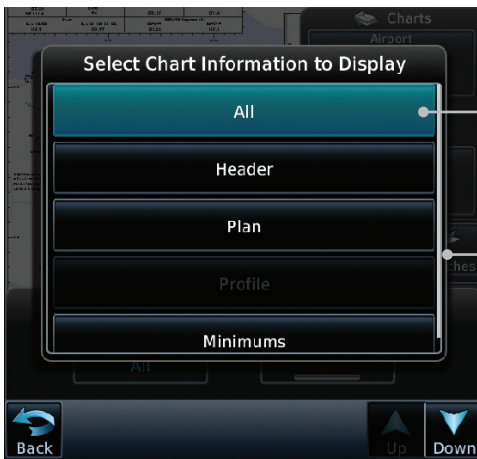

Current Selected Chart Layer

Touch To Select Chart Layer

Figure 7-16 Select From Chart Layer List

3. Touch the desired selection to display the selected Chart Layer.

7.2.1 Chart Layers - All



Touch the **All** key to view the composite of layers available for the selected chart.

7.2.2 Chart Layers - Header

Touch the **Header** selection from the Chart Layer list to view the header information for the selected approach chart.

The screenshot shows the 'Header View of Chart for the Selected Approach' for KPDX Portland Intl. The top section displays airport information: 'PORTLAND INTL', '25 MAR 07 (19-1)', 'D-ATIS 128.35', 'PORTLAND Approach (R) 124.35', 'Rwy 10L, 20R 118.7', 'NAVAIDS: Final Appch Crs', 'No FAF', 'CEILING 3500', and 'Refer to Planview'. Below this is a 'No Missed Approach Procedure.' section with notes: '1. Radar required. 2. Procedure not authorized at night. 3. Vertical Angle: Rwy 10R, LOC: I/PDX (0.2 3.00°), Rwy 10L, LOC: INDO (0.5 3.00°)'. The right-hand menu is titled 'Charts' and includes 'Airport KPDX Portland Intl Public', 'Portland, OR NW USA', 'Approach COLUMBIA VISUAL RWY 10L/R, (19-1)', 'Information Approaches', 'Departures Arrivals', and 'Airport Info'. The bottom navigation bar contains 'Back', 'Menu', 'Full', 'In', and 'Out' buttons. Callouts point to 'Selected Airport', 'Detailed View Of Selected Header', 'Selected Approach', and 'Touch Menu To Select Layers'.

Figure 7-17 Header View of Chart for the Selected Approach

7.2.3 Chart Layers - Plan

Touch the **Plan** selection from the Chart Layer list to view the Plan View for the selected approach chart.

The screenshot shows the 'Plan View of Chart for the Selected Approach' for KPDX Portland Intl. The left side is a map of the approach area, showing 'SALVIE ISLAND', 'LAKE VANCOUVER', 'COLUMBIA RIVER', 'CONFLUENCE OF RIVERS', 'WILAMETTE RIVER', 'HAYDEN ISLAND', 'ANTENNA FARM', and 'Portland Hillsboro'. The map includes a 'D.R. 0 200' RECOMMENDED 2500' (LOC ONE)' circle and various navigational markers. The right-hand menu is identical to Figure 7-17, showing 'Charts', 'Airport KPDX Portland Intl Public', 'Portland, OR NW USA', 'Approach COLUMBIA VISUAL RWY 10L/R, (19-1)', 'Information Approaches', 'Departures Arrivals', and 'Airport Info'. The bottom navigation bar contains 'Back', 'Menu', 'Full', 'In', and 'Out' buttons. Callouts point to 'Selected Airport', 'Detailed Plan View Of Selected Approach', and 'Selected Approach'.

Figure 7-18 Plan View of Chart for the Selected Approach

- Foreword
- Getting Started
- Audio & Xpdr Ctrl
- Com/Nav
- FPL
- Direct-To
- Proc
- Charts**
- Wpt Info
- Map
- Traffic
- Terrain
- Weather
- Nearest
- Services/Music
- Utilities
- System
- Messages
- Symbols
- Appendix

7.2.4 Chart Layers - Profile

Touch the **Profile** selection from the Chart Layer list to view the vertical profile of the selected approach.

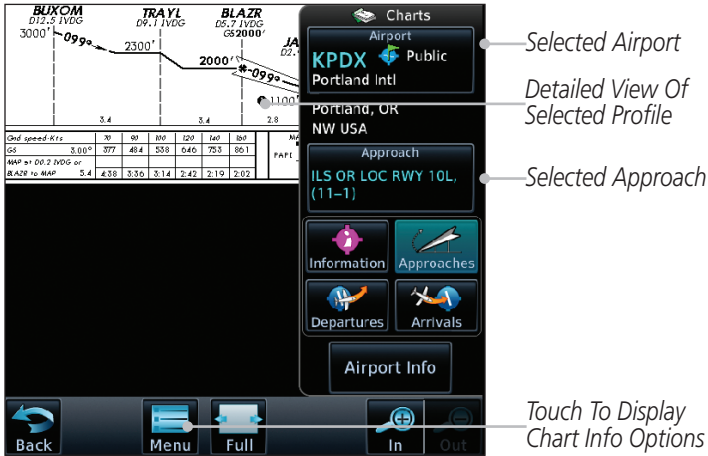

Figure 7-19 Profile View of Chart for the Selected Approach

7.2.5 Chart Layers - Minimums

Touch the **Minimums** selection from the Chart Layer list to view the minimums for the selected approach.



Figure 7-20 Minimums View of Chart for the Selected Approach

7.2.6 Invert Colors

Invert Colors

While viewing the Charts Menu, touch the **Invert Colors** key to show an inverted color view of the display that enhances low light viewing.

Inverted Color Chart Page View

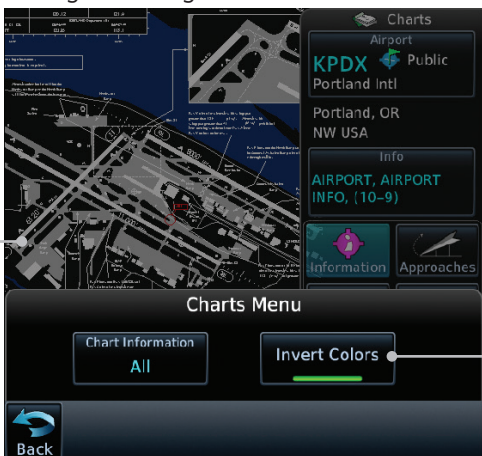

Touch For Inverted Color Chart Page View

Figure 7-21 Inverted Chart Colors View

7.2.7 Geo-Referenced Aircraft Position

The geo-referenced aircraft position is placed on the chart when a position is established. On the Map page, the chart and geo-referenced position are shown when the aircraft is in the air (such as, speed is greater than 30 knots). When a chart is viewed on the Map page, areas of the chart that do not support geo-referencing, such as expanded details and text blocks, are removed. Typically, SIDs and STARs are not geo-referenced and thus will not typically display the ownship symbol on those charts.



Geo-Referenced Aircraft Position

Figure 7-22 Areas of Chart Info Removed For Map Overlay and Geo-Reference



NOTE: The entire ownership symbol must be able to fit within the displayed chart area before it will be drawn.

7.3 ChartView Cycle Number and Revision

The ChartView database is revised every 14 days. Charts are still viewable during a period that extends from the cycle expiration date to the disables date. ChartView is disabled 70 days after the expiration date and is no longer available for viewing upon reaching the disable date. When turning on the GTN unit, the Power-up Page indicates the criteria for ChartView availability. An enablement card that is purchased from Garmin is separate from the Jeppesen database and is required to enable ChartView. Jeppesen charts that do not contain a specific effective date are effective upon receipt.

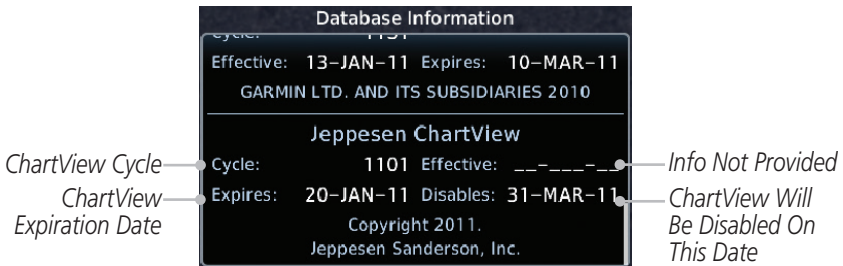

Figure 7-23 System Status Database Information for ChartView

The database CYCLE number, EXPIRES, and DISABLES dates of the ChartView database appear in either white or yellow text. When the ChartView EXPIRES date is reached, ChartView becomes inoperative 70 days later. This is shown as the DISABLES date. When the DISABLES date is reached, charts are no longer available for viewing.

The ChartView database is provided directly from Jeppesen. Refer to Jeppesen Databases in Appendix A for instructions on revising the ChartView database.

- Foreword
- Getting Started
- Audio & Xpdr Ctrl
- Com/Nav
- FPL
- Direct-To
- Proc
- Charts**
- Wpt Info
- Map
- Traffic
- Terrain
- Weather
- Nearest
- Services/Music
- Utilities
- System
- Messages
- Symbols
- Appendix

7.4 FliteCharts®

FliteCharts® resemble the paper version of National Aeronautical Charting Office (NACO) terminal procedures charts. The charts are displayed with high-resolution and in color for applicable charts.

Garmin FliteCharts is an electronic version of the National Aeronautical Navigation Services Charts (AeroNav Services), which was formerly NACO. FliteCharts lets pilots quickly find and view all AeroNav Services Departure Procedures (DP), Standard Terminal Arrival Routes (STARs), approach charts, and airport diagrams. If the current approach is known, the GTN 7XX automatically selects the correct chart based on the flight plan. Pilots will have access to all approach plates currently published by AeroNav, which encompasses over 15,000 charts and over 2,900 airports in the U.S. FliteCharts updates are available from Garmin every 28 days, and the new geo-referenced capability will be included with the regular updates.

FliteCharts database subscription is available from Garmin. Available data includes:

- Arrivals (STAR)
- Departure Procedures (DP)
- Approaches
- Airport Diagrams

7.4.1 FliteCharts Cycle Number and Revision

FliteCharts data is revised every 28 days. Charts are still viewable during a period that extends from the cycle expiration date to the disables date. FliteCharts is disabled 180 days after the expiration date and are no longer available for viewing upon reaching the disables date. When turning on the GTN 7XX, the Power-up page indicates the criteria for chart availability. These indications are whether the databases are not configured, not available, current, out of date, or disabled.

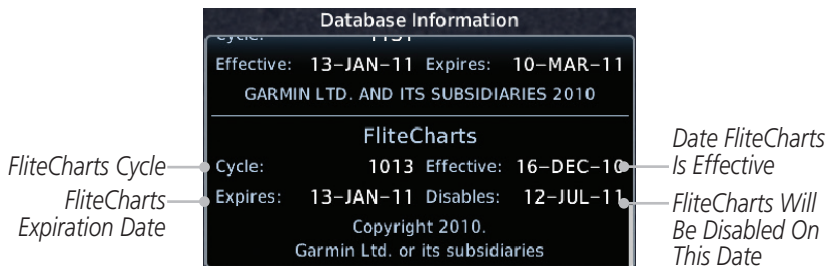

Figure 7-24 System Status Database Information for FliteCharts

7.5 SafeTaxi®

SafeTaxi® is an enhanced feature that gives greater map detail when zooming in on airports. The airport display on the map reveals runways with numbers, taxiways with identifying letters/numbers, airport Hot Spots, and airport landmarks including ramps, buildings, control towers, and other prominent features. Resolution is greater at lower map ranges (zooming in). When the aircraft location is within the screen boundary, including within SafeTaxi ranges, an airplane symbol is shown on any of the navigation map views for enhanced position awareness.



NOTE: Do not use SafeTaxi or Chartview functions as the basis for ground maneuvering. SafeTaxi and Chartview do not comply with the requirements of AC 120-76C and are not qualified to be used as an airport moving map display (AMMD). SafeTaxi and Chartview should only be used by the flight crew to orient themselves on the airport surface.

Designated Hot Spots are recognized at airports with many intersecting taxiways and runways, and/or complex ramp areas. Airport Hot Spots are outlined to caution pilots of areas on an airport surface where positional awareness confusion or runway incursions happen most often. Hot Spots are defined with a magenta circle or outline around the region of possible confusion.



Figure 7-25 SafeTaxi Depiction on the Navigation Map Page

7.5.1 Using SafeTaxi®

Any map page that displays the navigation view can also show the SafeTaxi® airport layout within the maximum configured range. Charts and SafeTaxi are mutually exclusive. So, to view SafeTaxi and Hot Spots, the Charts feature must be turned off. Charts are displayed when the aircraft is in the air, but when on the ground, charts are removed and SafeTaxi will be shown automatically.

During ground operations the aircraft's position is displayed in reference to taxiways, runways, and airport features. The nose of the ownship symbol, not the center, depicts the current location of the aircraft.

7.5.2 Hot Spot Information

Hot Spot locations are identified by a magenta circle or outline. To view more information touch the Hot Spot on the moving map.

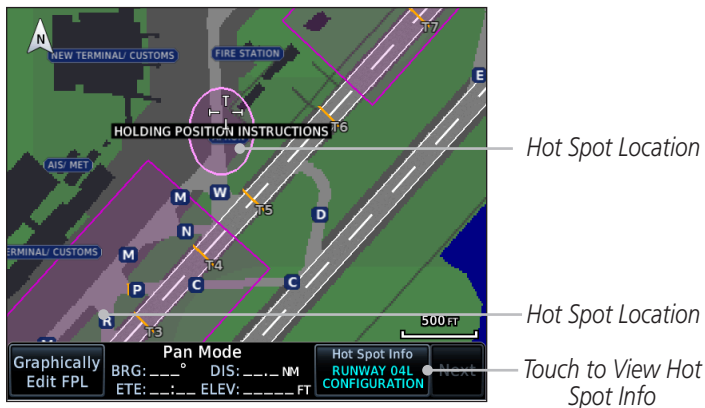

Figure 7-26 SafeTaxi Hot Spot Depiction

7.5.3 SafeTaxi® Cycle Number and Revision

The SafeTaxi database is revised every 56 days. SafeTaxi is always available for use after the expiration date. When turning on the GTN 7XX, the Power-up Page indicates whether the databases are current, out of date, or not available. The Power-up Page shows the SafeTaxi database is current when the “SafeTaxi Expires” date is shown in white. When the SafeTaxi cycle has expired, the “SafeTaxi Expires” date appears in yellow. The message “unknown” appears in white if no SafeTaxi data is available on the database card.

The SafeTaxi, Cycle, Effective date and Expires date of the database cycle can also be found on the System - System Status page. SafeTaxi information appears in white and yellow text. The EFFECTIVE date appears in white when data is current and in yellow when the current date is before the effective date. The EXPIRES date appears in white when data is current and in yellow when expired. SafeTaxi REGION NOT AVAILABLE appears in white if SafeTaxi data is not available on the database card.

Foreword

Getting Started

Audio & Xpdr Ctrl

Com/Nav

FPL

Direct-To

Proc

Charts

Wpt Info

Map

Traffic

Terrain

Weather

Nearest

Services/
Music

Utilities

System

Messages

Symbols

Appendix

Foreword

Getting
Started

Audio &
Xpdr Ctrl

Com/Nav

FPL

Direct-To

Proc

Charts

Wpt Info

Map

This page intentionally left blank

Traffic

Terrain

Weather

Nearest

Services/
Music

Utilities

System

Messages

Symbols

Appendix

8 WAYPOINT INFO

The Waypoint Info function allows you to view information about the selected waypoint. The Waypoint Info page can be reached from the Home page, selected from a flight plan, or selected from the Nearest page.



*Touch Key to Display
Waypoint Type*

Figure 8-1 Waypoint Info Page

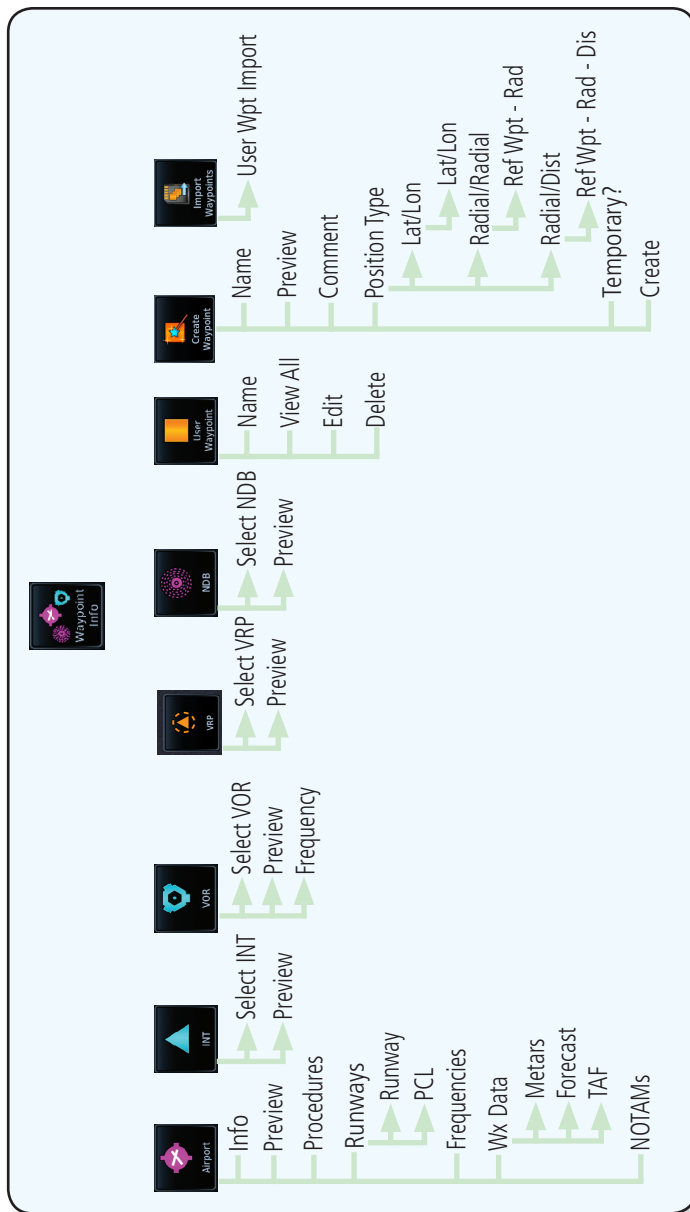

Figure 8-2 Waypoint Info Functional Diagram

8.1 Waypoint Selection



1. Touch the **Waypoint Info** key and then touch the desired waypoint type (Airport, INT, VOR, etc).
2. Touch the waypoint identifier.
3. The waypoint identifier selection page will be shown and the waypoint identifier field will be active for selection. Touch the required keys on the alphanumeric keypad to select the desired waypoint identifier and then touch the **Enter** key.



Figure 8-3 Waypoint Ident Selection

4. The information page for the selected waypoint will be displayed.



Figure 8-4 Waypoint Ident Selection Result

8.2 Airport

The Airport page of the Waypoint Info function provides a variety of detailed information about the airport.

8.2.1 Info

The upper part of the page shows the airport identifier and type, name, city and region, the lat/lon coordinates of the airport, and the bearing (and direction arrow) and distance to the airport from your present position. The center area shows the airport elevation, fuel availability, and time zone.

1. While viewing the Waypoint Info page, touch the **Airport** key.

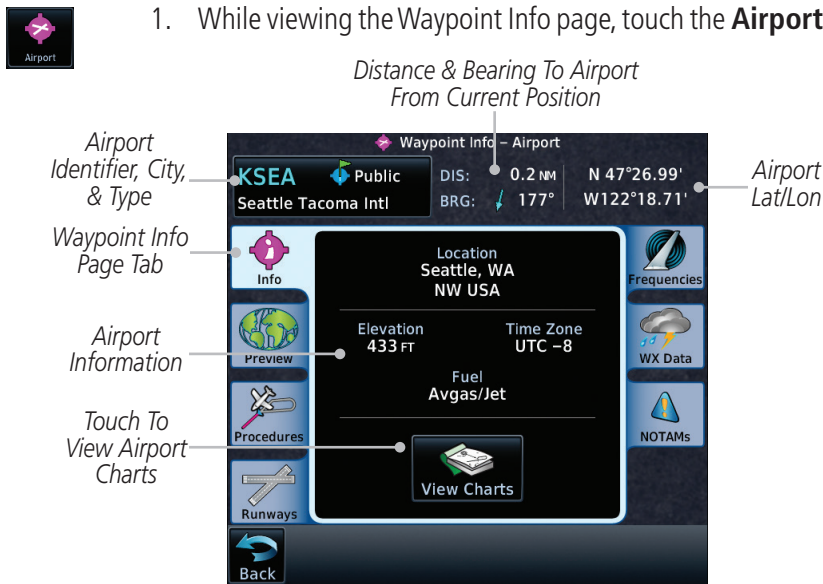
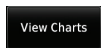

Figure 8-5 Waypoint Info Airport Page

2. Touch the **View Charts** key to display available charts for the airport.



8.2.2 Preview

The Waypoint Info Airport Preview page provides detailed information about the selected airport.



1. Touch the **Preview** tab to view a map of the airport and surrounding area.
2. Use the **In** and **Out** keys to zoom in and out on the Preview map.



Figure 8-6 Waypoint Info Airport Map Page

3. You may touch the map window and while pressing the display drag your finger to move the map view.

8.2.3 Procedures

1. Touch the **Procedures** page tab to view details about procedures for the selected airport.



Distance & Bearing To Airport
From Current Position

Airport Identifier, City, & Airport Type

Airport Lat/Lon

Approach Name & Type

Procedures Page Tab

Touch To Scroll

Figure 8-7 Waypoint Info Airport Procedures Page

2. Touch the **Up** and **Down** keys to view additional procedures, as needed.
3. Touch one of the procedure keys to select it for the Procedures function.

Distance & Bearing To Airport
From Current Position

Airport Identifier, City, & Airport Type

Airport Lat/Lon

Arrival Name

Procedures Page Tab

Touch To Scroll

Figure 8-8 Waypoint Info Airport Arrival Information

8.2.4 Runways



Figure 8-9 Waypoint Info Airport Runway Information Page

1. Touch the **Runways** tab to view information about the available runways for the selected airport. The runway identifiers, surface type, lighting with Pilot Controlled Lighting (PCL) frequency, runway size, and Traffic Pattern direction are shown.
2. Touch the **PCL** key to load the PCL frequency into the Com Standby location.

Foreword
Getting Started
Audio & Xpdr Ctrl
Com/Nav
FPL
Direct-To
Proc
Charts
Wpt Info
Map
Traffic
Terrain
Weather
Nearest
Services/Music
Utilities
System
Messages
Symbols
Appendix

8.2.5 Frequencies



1. Touch the **Frequencies** tab to view details about available frequencies for the selected airport.
2. Touch the **Up** and **Down** keys to view additional frequencies, as needed. A "c" symbol in a white circle will appear next to frequencies that also function as the Common Traffic Advisory Frequency (CTAF).

*Distance & Bearing To Airport
From Current Position*

*Airport
Identifier, City,
& Airport Type*

*Airport
Lat/Lon*

*Airport
Frequencies
Page Tab*

*"c" Indicates
CTAF*

*Touch Frequency
Key To Load Into
Com Standby*

*Touch
To Scroll*

Figure 8-10 Waypoint Info Airport Frequency List Page

3. Touch the **Frequency** key next to the frequency name to load it as the Com or Nav standby frequency, depending on frequency type.

122.95

8.2.6 Weather (WX) Data



1. Touch the **WX Data** tab next to the center window to view textual METARs, City Forecast, and TAF weather information available for the selected airport.



Figure 8-11 Waypoint Info Airport Weather Page



2. Touch the **Up** and **Down** keys to scroll through the Weather page information.



Figure 8-12 Waypoint Info Airport Weather Forecast Page

Foreword
Getting Started
Audio & Xpdr Ctrl
Com/Nav
FPL
Direct-To
Proc
Charts
Wpt Info
Map
Traffic
Terrain
Weather
Nearest
Services/Music
Utilities
System
Messages
Symbols
Appendix

8.2.7 NOTAM Pages



1. Touch the **NOTAMs** tab next to the center window to view any NOTAMs available for the selected airport. This feature is supported with ChartView and FIS-B.



Figure 8-13 Waypoint Info Airport NOTAMs Page

2. Touch the **Up** and **Down** keys to view additional information, as needed.



8.2.8 Helipads



1. Touch the **Helipad** tab next to the center window to view any information available for the selected helipad. Helipad information may not be complete or consistent due to the data available from the 3rd party sources.

*Distance & Bearing To Helipad
From Current Position*

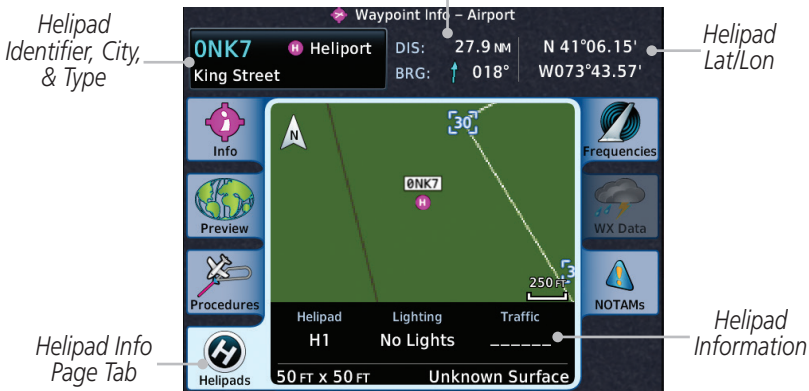

Figure 8-14 Helipad Waypoint Info

8.2.9 Nearest VRPs



1. Touch the **NRST VRPs** tab for a list of the visual reporting points located near the selected airport.



Figure 8-15 Waypoint Info Airport NRST VRPs Page



2. Touch the **Up** and **Down** keys to view additional information, as needed.

Foreword

Getting Started

Audio & Xpdr Ctrl

Com/Nav

FPL

Direct-To

Proc

Charts

Wpt Info

Map

Traffic

Terrain

Weather

Nearest

Services/ Music

Utilities

System

Messages

Symbols

Appendix

8.3 Intersection (INT)

The Intersection page of the Waypoint Info function provides a variety of detailed information about the intersection. The top left area of the page displays the Intersection identifier and region. The top center area shows the lat/lon coordinates of the Intersection and the bearing (with direction arrow) and distance to the Intersection from your present position.

Select another Waypoint by touching the **Waypoint Identifier** key, entering the characters for the desired name with the alphanumeric keypad, and then touching the **Enter** key. You may also search through the list by touching the **Find** key and then choosing from the existing list of waypoints by touching the desired waypoint from the list.

The center area of the page shows a map with the Intersection in the center.

1. While viewing the Waypoint Info page, touch the **Intersection** key.

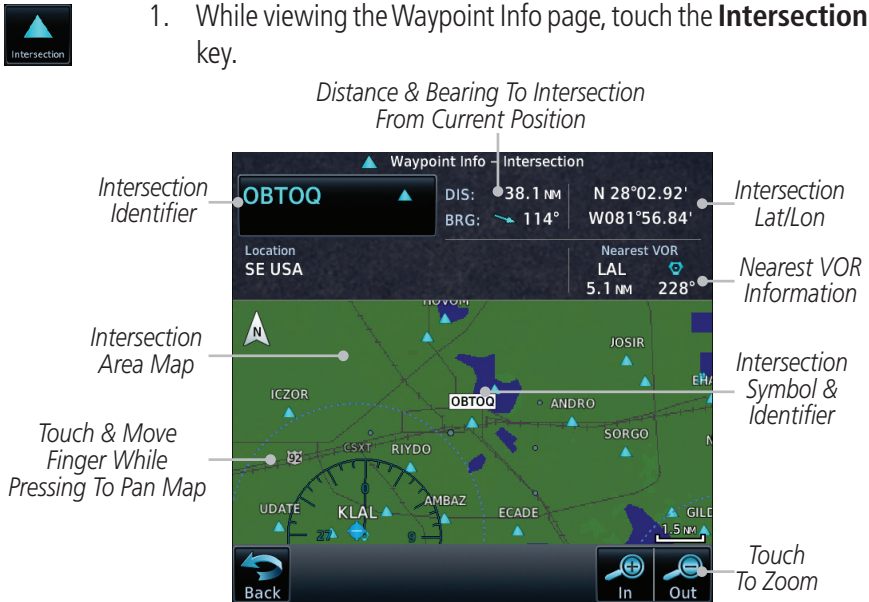

Figure 8-16 Waypoint Info - Intersections

2. Use the **In** and **Out** keys to zoom in and out on the map. You may touch the map window and while lightly pressing the display, drag your finger to move the map view.



8.4 VOR

The VOR page of the Waypoint Info function provides a variety of detailed information about the VOR. The top left area of the page displays the VOR identifier, name, city and state, and region. The top center area shows the lat/lon coordinates of the VOR and the bearing (with direction arrow) and distance to the VOR from your present position. The top right area shows the frequency in a key. Select another Waypoint by touching the **Waypoint Identifier** key, entering the characters for the desired name with the alphanumeric keypad, and then touching the **Enter** key. You may also search through the list by touching the **Find** key and then choosing from the existing list of waypoints by touching the desired waypoint from the list.

The center area of the page shows a map with the VOR in the center.



1. While viewing the Waypoint Info page, touch the **VOR** key.

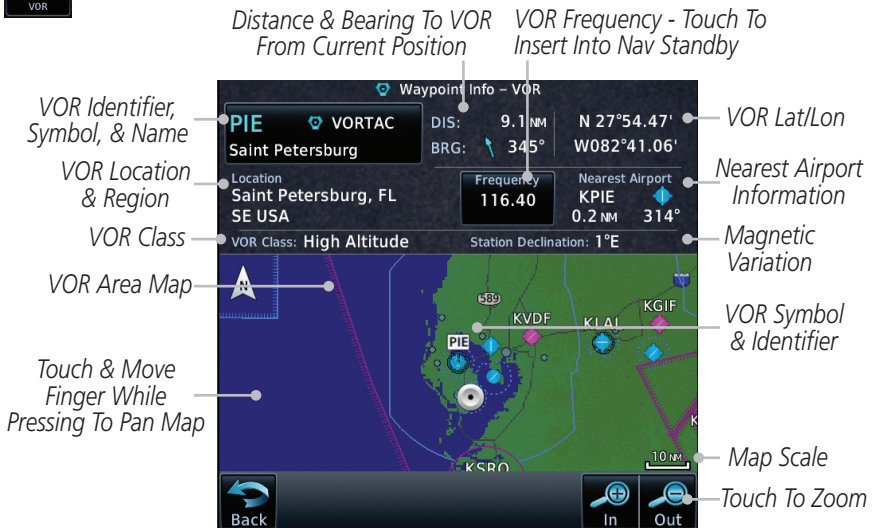

Figure 8-17 Waypoint Info - VORs



2. Use the **In** and **Out** keys to zoom in and out on the map. You may touch the map window and while lightly pressing the display, drag your finger to move the map view.



3. Touch the **Frequency** key next to load it as the Nav standby frequency.

8.5 VRP



NOTE: This feature is available in software v6.20 or later.



NOTE: Visual Reporting Point database coverage is not available in all regions.

The VRP (Visual Reporting Point) page of the Waypoint Info function provides information about the VRP. The top area displays the Lat/Lon coordinates of the VRP and the bearing (with direction arrow) and distance to the VRP from your present position. Select another Waypoint by touching the **Waypoint Identifier** key, entering the characters for the desired name with the alphanumeric keypad, and then touching the **Enter** key. You may also search through the list by touching the **Find** key and then choosing from the existing list of waypoints by touching the desired waypoint from the list. The center area of the page shows a map with the VRP in the center.

1. While viewing the Waypoint Info page, touch the **VRP** key.

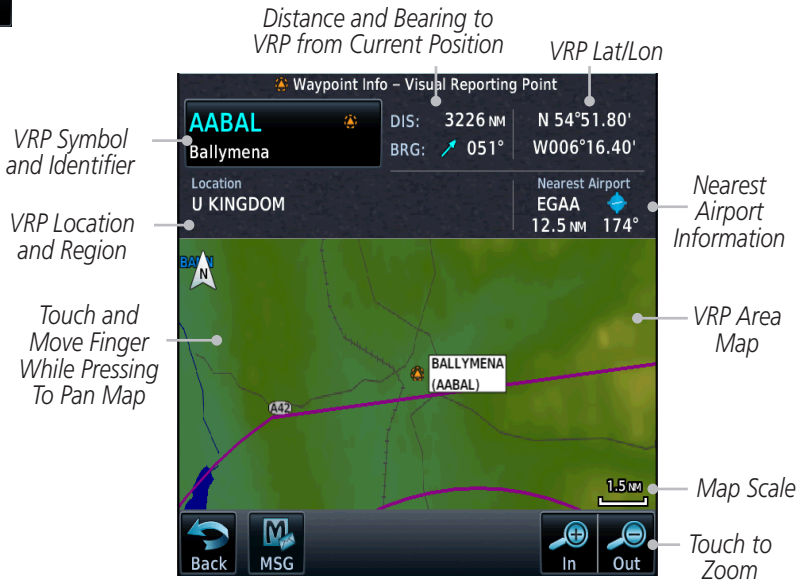

Figure 8-18 Waypoint Info -Visual Reporting Point

2. Use the **In** and **Out** keys to zoom in and out on the map. You can touch the map window and while lightly pressing the display, drag your finger to move the map view.



8.6 NDB

The NDB page of the Waypoint Info function provides a variety of detailed information about the NDB. The top left area of the page displays the NDB identifier, name, city and state, and region. The top center area shows the lat/lon coordinates of the NDB and the bearing (with direction arrow) and distance to the NDB from your present position. The top right area shows the frequency in a key.

Select another Waypoint by touching the **Waypoint Identifier** key, entering the characters for the desired name with the alphanumeric keypad, and then touching the **Enter** key. You may also search through the list by touching the **Find** key and then choosing from the existing list of waypoints by touching the desired waypoint from the list.

The center area of the page shows a map with the NDB in the center.

1. While viewing the Waypoint Info page, touch the **NDB** key.



Figure 8-19 Waypoint Info for NDBs

2. Use the **In** and **Out** keys to zoom in and out on the map. You may touch the map window and while lightly pressing the display, drag your finger to move the map view.



8.7 User Waypoints



NOTE: User airport feature is available in software v6.50 and later.

In addition to the airport, VOR, NDB and intersection information contained in the navigation database, the GTN 7XX allows you to store up to 1,000 user-defined waypoints. The User Waypoint page displays the waypoint name (up to six characters long), location, and elevation (user airports only).

To minimize nuisance terrain alerting when landing at airports not in the navigation database, user waypoints may be configured as user airports. User airports display on both the Waypoint Info and Nearest Airport pages.



Figure 8-20 Waypoint Info for a User Waypoint

Select User Waypoint by Name



1. While viewing the User Waypoint page, touch the User Waypoint Name.



2. Use the keypad to select the characters for the name and then touch **Enter**.

8.7.1 Select User Waypoint from a List



1. While viewing the Waypoint Info page, touch the **User Waypoint** key.



2. Touch the **View List** key and then use the **Up** and **Down** keys to view the waypoints on the list.



User
Waypoint
List Name

User
Waypoint
Type



User
Waypoint
List

Figure 8-21 Waypoint Info User Waypoint List

8.7.2 Edit User Waypoint



1. Select the desired User Waypoint and touch the **Edit** key.
2. Touch the key for the desired information and make changes as needed.

8.7.3 Delete User Waypoint



1. Select the desired User Waypoint and touch the **Delete** key.
2. Touch the **OK** key to confirm deleting the selected waypoint.

8.7.4 Delete All User Waypoints

1. While viewing the Waypoint Info page, touch the **User Waypoint** key.
2. Touch the **View List** key and then touch the **Menu** key to open the User Waypoints Menu.



*Touch to Filter
Waypoints to
Delete*

*Touch to
Delete All User
Waypoints*

Figure 8-22 User Waypoints Menu

3. Touch the **Filter** key to select which type of user waypoints to delete: All, Basic, or Mark On Target.
4. Touch the **Delete All** key to delete all of the user waypoints.

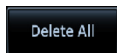
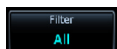

8.8 Create Waypoint

User waypoints are created from the Create User Waypoint page. To create a new user waypoint, simply enter its name (identifier) and position, or reference another waypoint by radial and distance.



Figure 8-23 Waypoint Info - Create User Waypoint



1. From the Waypoint Info page, touch the **Create Waypoint** key.
2. Touch the **User Identifier** key.
3. Use the keypad to type the waypoint name (up to six characters) and then touch **Enter**.



Figure 8-24 Waypoint Info - Create User Waypoint Name

Foreword

Getting Started

Audio & Xpdr Ctrl

Com/Nav

FPL

Direct-To

Proc

Charts

Wpt Info

Map

Traffic

Terrain

Weather

Nearest

Services/ Music

Utilities

System

Messages

Symbols

Appendix

Index



- If desired, touch the **Airport** key to make the user waypoint a user airport.
- Touch the **Comment** key to add a short comment for the new waypoint.
- Touch the **Position Type** key and then **Lat/Lon**, **Radial/Radial**, or **Radial/Distance** to assign the type. See the following instructions for more detail.

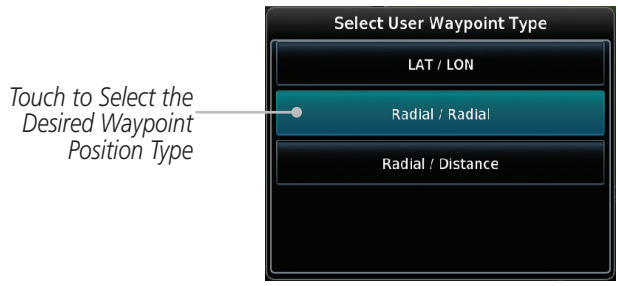
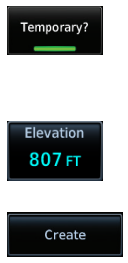

Figure 8-25 Waypoint Info - Create User Position Type



- If desired, touch the **Temporary?** key to create the waypoint for only temporary use. Temporary waypoints will be removed when the power is cycled.
- For user airports, touch the **Elevation** key and specify airport elevation.
- When finished with all selections, touch the **Create** key to create the new waypoint.

8.8.1 Mark On Target

NOTE: This feature is available in software v4.00 and later.

If an external Mark On Target (MOT) switch is installed, pressing that switch will result in the creation of a User waypoint called MOTxxx at the point in space where the MOT switch was pushed. The waypoints are created in increasing numeric order up to number 999, at which point they will start replacing existing waypoints at the beginning of the list.

When a Mark on Target waypoint is created, it may not be immediately visible on the moving map page because the ownship icon will be directly on top of the waypoint. Creation of the waypoint can be verified by changing zoom scales on the map or viewing the User Waypoints page.

8.8.2 Waypoint Location Based on LAT/LON



- From the Create User Waypoint page, touch the **Position Type** key and then the **LAT/LON** key. Then, touch the **Latitude/Longitude** value key.

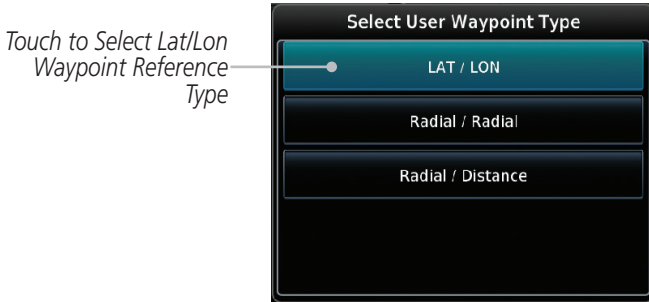

Figure 8-26 Waypoint Info - Create User Waypoint Type - LAT/LON



- The Lat/Lon coordinate values will be highlighted. Touch the **Lat** or **Lon** key to toggle selection of the hemisphere values and highlight the selected value.

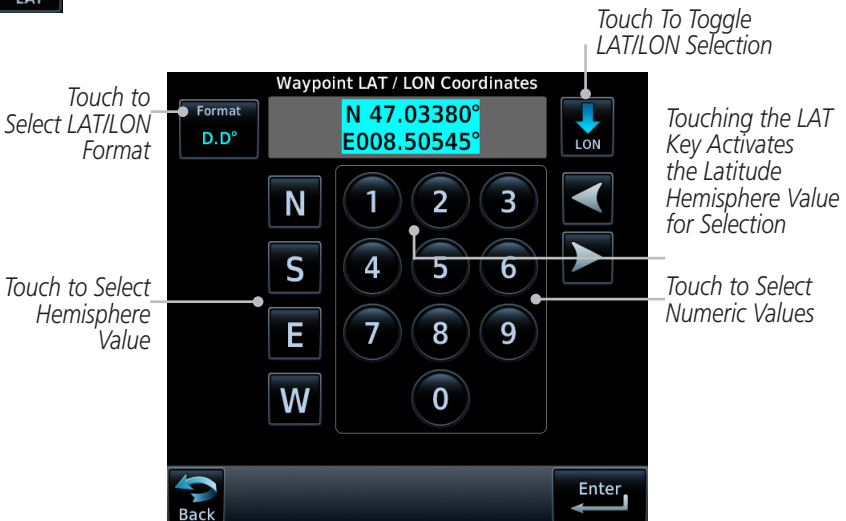
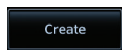

Figure 8-27 Waypoint Info - Set Lat/Lon Coordinate Selection

- Foreword
- Getting Started
- Audio & Xpdr Ctrl
- Com/Nav
- FPL
- Direct-To
- Proc
- Charts
- Wpt Info
- Map
- Traffic
- Terrain
- Weather
- Nearest
- Services/ Music
- Utilities
- System
- Messages
- Symbols
- Appendix



3. Touch the desired hemisphere keys to select the desired values. After selecting the hemisphere value, the cursor will advance to the first character of the adjacent numeric value for selection. Even when the hemisphere values are highlighted, touching the numeric keys will always place the cursor at the first numeric value.
4. When finished with the Lat/Lon selections, touch the **Enter** key.
5. When finished with all selections, touch the **Create** key to create the new waypoint.

8.8.3 Waypoint Location Based on Two Radials



1. From the Create User Waypoint page, touch the **Position Type** key and then the **Radial/Radial** key.

Touch to Select Radial/Radial Waypoint Reference Type

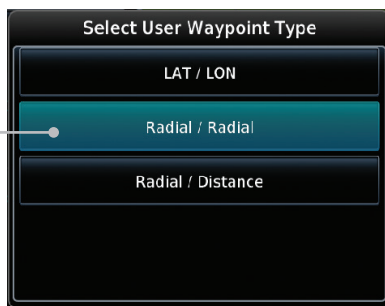

Figure 8-28 Waypoint Info - Create User Waypoint Type - Radial/Radial



2. Touch the **Ref Wpt** key and use the alphanumeric keypad to select the desired identifier.
3. Touch the upper **Radial** key and use the alphanumeric keypad to select the desired value.
4. Touch the **Enter** key.
5. When finished with all selections, touch the **Create** key to create the new waypoint.

8.8.4 Waypoint Location Based on Radial and Distance

Position Type
Radial / Radial

1. From the Create User Waypoint page, touch the **Position Type** key and then the **Radial/Distance** key.

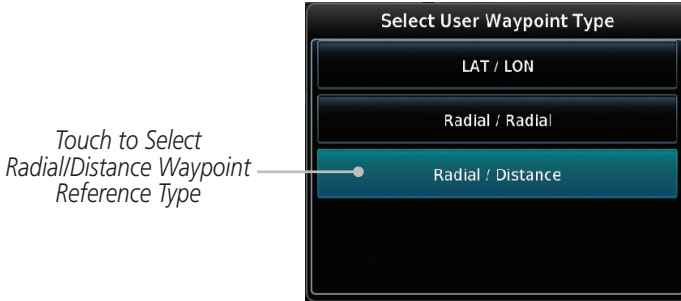

Figure 8-29 Waypoint Info - Create User Waypoint Type - Radial/Distance

REF WPT
UBG

2. From the Create User Waypoint page, touch the **Ref Wpt** key and use the alphanumeric keypad to select the desired identifier.

Radial
161°

3. Touch the upper **Radial** key and use the alphanumeric keypad to select the desired value.

Distance
26.6NM

4. Touch the upper **Distance** key and use the alphanumeric keypad to select the desired value.

←
Enter

5. Touch the **Enter** key.

Create

6. Touch the **Create** key to save the new waypoint.

8.9 Import User Waypoints (Datacard)



NOTE: This feature is available in software v5.10 and later.

The GTN can import user generated waypoints from a file on the datacard. The created waypoints will be at the latitude and longitude specified in the file with the specified name and comment. This function overwrites any existing user waypoints with the same name.

When a user waypoint file is on the datacard, a key will be available on the Waypoint Info page for importing user waypoints.

1. Insert a datacard with the User waypoints into the GTN.
2. From the Waypoint Info page, touch the **Import Waypoints** key.
3. Touch **OK** to acknowledge the pop-up to import all of the user waypoints in the file.

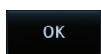

Figure 8-30 Start User Waypoint Import

4. The pilot is informed of the status of the user waypoint import via one of the following system messages.

Message	Description
USER WAYPOINT IMPORT - User waypoints were imported successfully.	All user waypoints were imported successfully.
USER WAYPOINT IMPORT - User waypoint import failed.	User waypoint import failed due to improper file format.
USER WAYPOINT IMPORT - User waypoint import failed. User waypoint database is full.	User waypoint catalog is full and the requested user waypoints could not be imported.
USER WAYPOINT IMPORT - User waypoints imported successfully - existing waypoints reused.	User waypoints imported and existing waypoints are used instead of creating duplicate waypoints. This occurs when a waypoint to be imported is within 0.001° latitude and longitude of an existing user waypoint (roughly a few hundred feet, depending on latitude).

Table 8-1 User Waypoint Import Messages

For more details on importing user waypoints, visit flyGarmin.com.

Foreword

Getting
Started

Audio &
Xpdr Ctrl

Com/Nav

FPL

Direct-To

Proc

Charts

Wpt Info

Map

This page intentionally left blank

Traffic

Terrain

Weather

Nearest

Services/
Music

Utilities

System

Messages

Symbols

Appendix

9 MAP

The Map page is used to provide situational awareness in flight. The Map page can display the following information:

- Airports, NAVAIDs, airspace, airways, land data (highways, cities, lakes, rivers, borders, etc.) with names
- Wind direction and speed
- Icons for enabled map features
- Aircraft icon (with the nose representing present position)
- Nav range ring
- Flight plan legs
- Topography scale
- Topography data
- NEXRAD (or Precip) Weather (Opt.)
- ChartView or FliteChart Overlay
- Terrain Overlay
- Traffic Overlay
- Radar Overlay
- Fuel Range Ring (SW v6.00 or later)
- Track vector (SW v6.20 or later)



Figure 9-1 Map Page Description



The following information describes the ownship symbol behavior in a helicopter that does not have a source of magnetic heading information connected to the GTN.

Foreword
Getting Started
Audio & Xpdr Ctrl
Com/Nav
FPL
Direct-To
Proc
Charts
Wpt Info
Map
Traffic
Terrain
Weather
Nearest
Services/Music
Utilities
System
Messages
Symbols
Appendix

When greater than 15 knots groundspeed the map is oriented either north up with ownship oriented to its current track or track up. When less than 15 kts groundspeed, the directional ownship icon is replaced with a non-directional icon because it can't be determined if the rotorcraft is going sideways or backwards. The map will continue to orient to the current track if the map is selected for Track Up. If the map is oriented to track up, then below 5 kts groundspeed the map orientation will "latch" to the last valid track prior to the groundspeed going below 5 kts. The map will reorient when the groundspeed again exceeds 5 kts. The position of the ownship icon over the map is always the current GPS position of the aircraft.



NOTE: *The electronic map is an aid to navigation and is designed to facilitate the use of authorized government charts, not replace them. Land and water data is provided only as a general reference. The accuracy of the land and water data is not suitable for use as a primary source of navigation and should only be used to supplement official government charts and notices.*

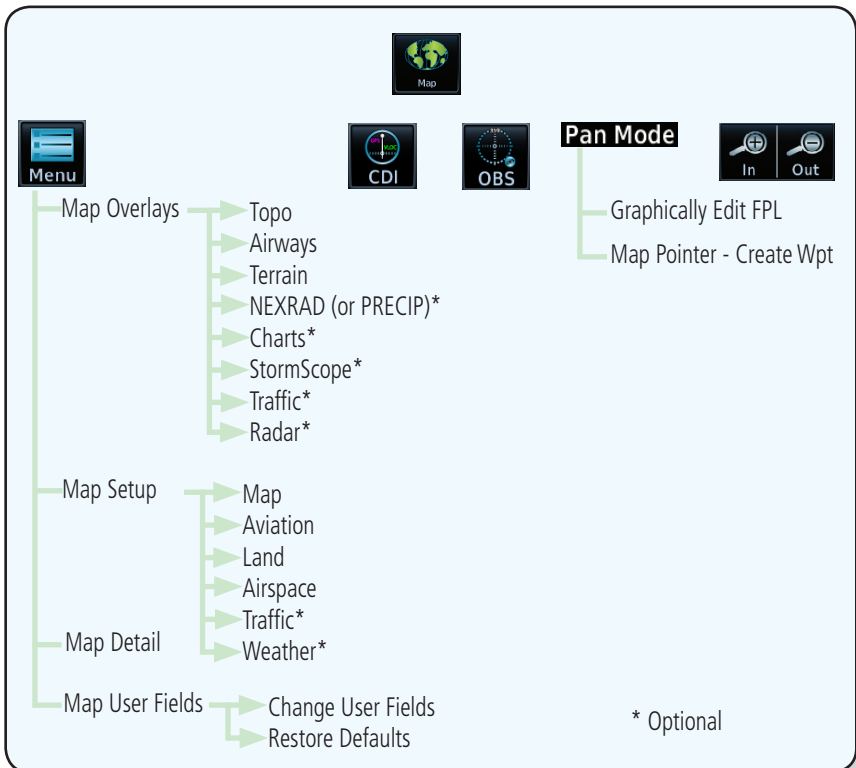

Figure 9-2 Map Page Functional Diagram



NOTE: NEXRAD (or PRECIP) and Radar may not be shown at the same time.

9.1 Map Menu

The Map Menu provides the ability to modify and control the information displayed on the Map page.

- Map Overlays are selected to overlay various types of information over the base map.
- Map Setup modifies the display of other map features.
- Map User Fields determines whether or not the fields in the corners of the Map page are displayed and the data shown in each corner.
- Map Detail lets you control the amount of information displayed at different map ranges.
- Restore Defaults lets you start all over again with the default values for the settings for the Map User Fields.



NOTE: Changes made in the Map Menu take effect immediately on the map display.



1. From the Home page, touch **Map** to reach the Map page, or press and hold the **HOME** key to go to the Map page from any function. On the Map page, touch the **Menu** key.

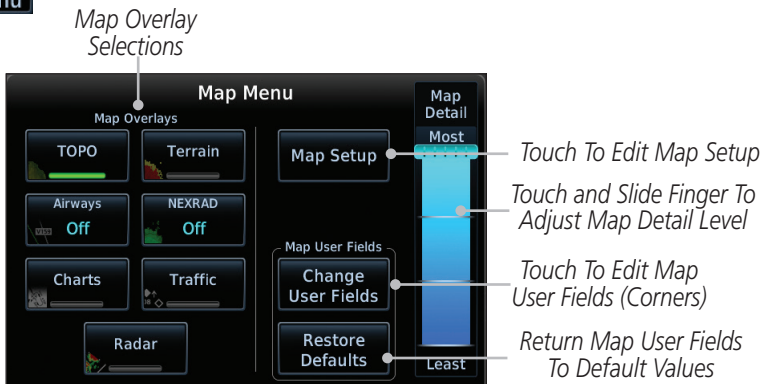

Figure 9-3 Map Menu

2. Touch the key for the desired option to access its settings.



3. Touch the **Back** key to return to the Map page. Any changes made will be retained until changed.

9.1.1 Map Overlays

Map Overlays are layers of information that are referenced to geographic location and are overlaid on the base map. A green bar will appear below the Map Overlay key text when the overlay is selected, except for Airways and NEXRAD.



NOTE: Data linked weather (SiriusXM / FIS-B / Connex) is displayed below the chart overlay, Active onboard RADAR overlay is displayed above the chart overlay.



NOTE: Map overlay keys do not turn on or activate equipment necessary for the overlay to function. Map overlay keys may remain available even if the information necessary for the overlay is not available. For example: the Radar overlay key is available even if the radar is turned off.



NOTE: Map overlays for StormScope, Traffic, or Radar are prevented from being overlaid on the main map without a heading source or while User Navigation Angles are selected.

9.1.1.1 Overlay Priority

The data overlaid on the map is displayed according to the following priorities (from highest to lowest):

1 - Traffic	10 - TFRs	19 - County Warning	28 - Icing Potential
2 - Ownship	11 - Freezing Levels	20 - PIREPs	29- Echo Tops
3 - Flight Plan	12 - Cell Movement	21 - AIREPS	30 - NEXRAD
4 - TAWS Alerts	13 - Lightning	22 - City Forecast	31 - Cloud Tops
5 - Weather Radar	14 - METARs	23 - Surface Analysis	32 - IR Satellite
6 - Charts	15 - Winds Aloft	24 - Airspace	33 - SafeTaxi
7 - Stormscope	16 - SIGMETs	25 - Waypoints	34 - Terrain
8 - Obstacles	17 - AIRMETs	26 - Airways	35 - Base Map
9 - Fuel Range Ring	18 - Cyclone Warning	27 - Turbulence	36 - Topo

Table 9-2 Data Overlay Priority

9.1.1.2 Topo

The Topo Data option selects whether the colored topographical features are displayed. Traffic, Land Data, Terrain, and Obstacles will still be displayed even with Topo Data turned off.

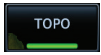

1. While viewing the Map Menu, touch the **TOPO** Map Overlay key to toggle the Topo setting.



Topo Map Overlay Off



Topo Map Overlay On

Figure 9-4 Topo Map Overlay Selections

2. When the Topo Map Overlay is toggled off, all topographic color features are removed.

Foreword

Getting Started

Audio & Xpdr Ctrl

Com/Nav

FPL

Direct-To

Proc

Charts

Wpt Info

Map

Traffic

Terrain

Weather

Nearest

Services/
Music

Utilities

System

Messages

Symbols

Appendix

9.1.1.3 Airways

The Airways option allows you to select the airways that are shown on the Map page. All, Low only, and High only Airways may be selected. When Off is selected, airways will not be shown.

1. While viewing the Map Menu, touch the **Airways** Map Overlay key to select the Airways viewed. Selections are: Off, Low, High, and All.



Figure 9-5 Airways Map Overlay

2. Low Airways are shown as gray lines. High Airways are shown as green lines.

Foreword
Getting Started
Audio & Xpdr Ctrl
Com/Nav
FPL
Direct-To
Proc
Charts
Wpt Info
Map
Traffic
Terrain
Weather
Nearest
Services/Music
Utilities
System
Messages
Symbols
Appendix

9.1.1.4 Terrain

The Terrain Data option selects whether Terrain Data is shown on the Map page. Terrain and NEXRAD weather may not be displayed at the same time. Selecting one will disable the other. A Terrain icon will indicate that the Terrain overlay has been selected. Terrain overlay colors may or may not be shown depending on the altitude of the aircraft.

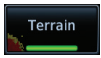

1. While viewing the Map Menu, touch the **Terrain** Map Overlay key to toggle the view of Terrain data.

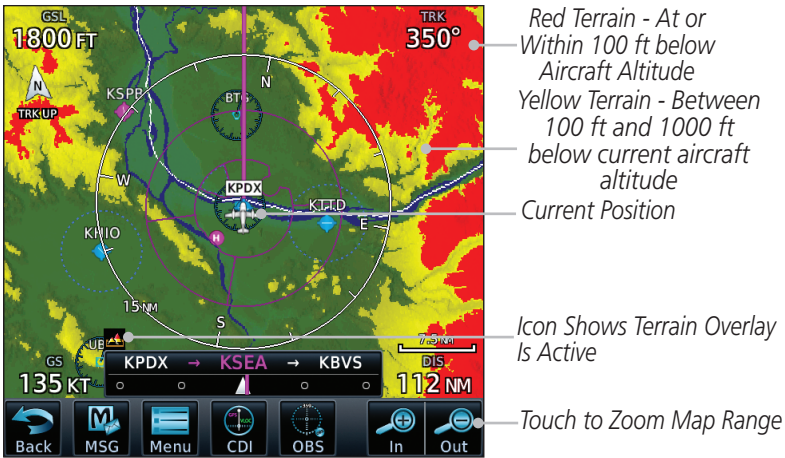

Figure 9-6 Terrain Map Overlay

2. The colors of the terrain are referenced to your aircraft altitude.

9.1.1.5 NEXRAD (Optional)

The NEXRAD menu option allows the display of NEXRAD Precip weather information overlaid on the Map page. Terrain and NEXRAD Precip weather may not be displayed at the same time. Selecting one will disable the other. NEXRAD Precip weather is an optional feature that requires the installation of a GDL 69/69A, GDL 88, GTX 345, or GSR 56 and an appropriate Weather subscription. Only one weather source can be displayed at a time (i.e., FIS-B and XM cannot be displayed on the map simultaneously). See the Weather section for more detail.



While viewing the Map Menu, touch the **NEXRAD** Map Overlay key to toggle the view of NEXRAD weather data.



Figure 9-7 NEXRAD Map Overlay

9.1.1.6 Charts (Optional)

The Charts menu option allows the display of Charts overlaid on the Map page. The Charts Map Overlay option selects whether Chart data is shown on the Map page. Charts may or may not be shown depending on the other aircraft's location. The ownship icon will be shown over an available chart. See the Charts section for more detail.

A chart will be displayed on the map if all of the following are true:

- A charts database is a valid database.
- The system date is prior to the disable date of the charts database.
- The Charts Overlay Setting is active.
- The aircraft is In Air.

The chart displayed on the map will be chosen based on:

- The approach chart for the approach in the active flight plan, if an approach exists in the active flight plan.
- The airport surface chart for the nearest airport, if no approach exists in the active flight plan and an airport exists within 200NM of the aircraft's current position.



NOTE: Features that are selectable on the main map page, such as obstacles, airports, airspace, and other waypoint types that are not visible beneath the overlaid chart, remain selectable even when an approach chart is overlaid on the main map.



NOTE: If the chart for the loaded approach procedure is not overlaid on the map page with the Chart Overlay active, ensure the correct chart is selected on the dedicated Charts page.



NOTE: If two GTN 7XX units are crossfilled, then the same type (ChartView or FlightCharts) and version (cycle number and effective dates) for the chart database must be installed on both units in order for the correct chart to be overlaid on the main map page.

- Foreword
- Getting Started
- Audio & Xpdr Ctrl
- Com/Nav
- FPL
- Direct-To
- Proc
- Charts
- Wpt Info
- Map
- Traffic
- Terrain
- Weather
- Nearest
- Services/ Music
- Utilities
- System
- Messages
- Symbols
- Appendix

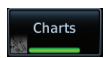

While viewing the Map Menu, touch the **Charts** Map Overlay key to toggle the view of the Charts overlay.



Chart Overlay Selected In The Map Menu

Ownship Located on Chart Overlay

Figure 9-8 Charts Map Overlay

9.1.1.7 StormScope® (Optional)

The WX-500 StormScope Weather Mapping Sensor is a passive weather avoidance system that detects electrical discharges associated with thunderstorms within a 200 NM radius of the aircraft. The StormScope measures relative bearing and distance of thunderstorm-related electrical activity and reports the information to the display. Stormscope and XM Lightning are mutually exclusive.



NOTE: *The StormScope map overlay is only displayed if valid aircraft heading information is available. Refer to the WX-500 Pilot's Guide for a detailed description of the WX-500 StormScope.*

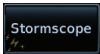

1. While viewing the Map Menu, touch the **StormScope** Map Overlay key to show the menu for selecting the StormScope radar weather data display mode (Cell, Strike, Off, or Clear Strikes).



Select StormScope Data Display

Figure 9-9 StormScope Map Overlay Selections

2. StormScope data will be overlaid on the Map page when Cell or Strike is selected. See the Weather section for more details.



Icon Shows Stormscope Overlay Is Active

Figure 9-10 StormScope Map Overlay

9.1.1.8 Radar (Optional)

With the exception of WATCH Shading, all radar settings specified on the Weather Radar page are applied to the radar map overlay. NEXRAD/PRECIP and the Radar overlay may not be shown at the same time.

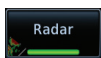

While viewing the Map Menu, touch the **Radar** Map Overlay key to toggle the view of airborne Radar data.



Figure 9-11 Radar Map Overlay

9.1.1.9 Traffic (Optional)

The Traffic Map Overlay option selects whether Traffic data is shown on the Map page. A Traffic icon will indicate that the Traffic overlay has been selected. Traffic may or may not be shown depending on the other aircraft's location and equipment. See the Traffic section for more detail.



While viewing the Map Menu, touch the **Traffic** Map Overlay key to toggle the view of Traffic data.



Figure 9-12 Traffic Map Overlay

9.1.2 Map Setup

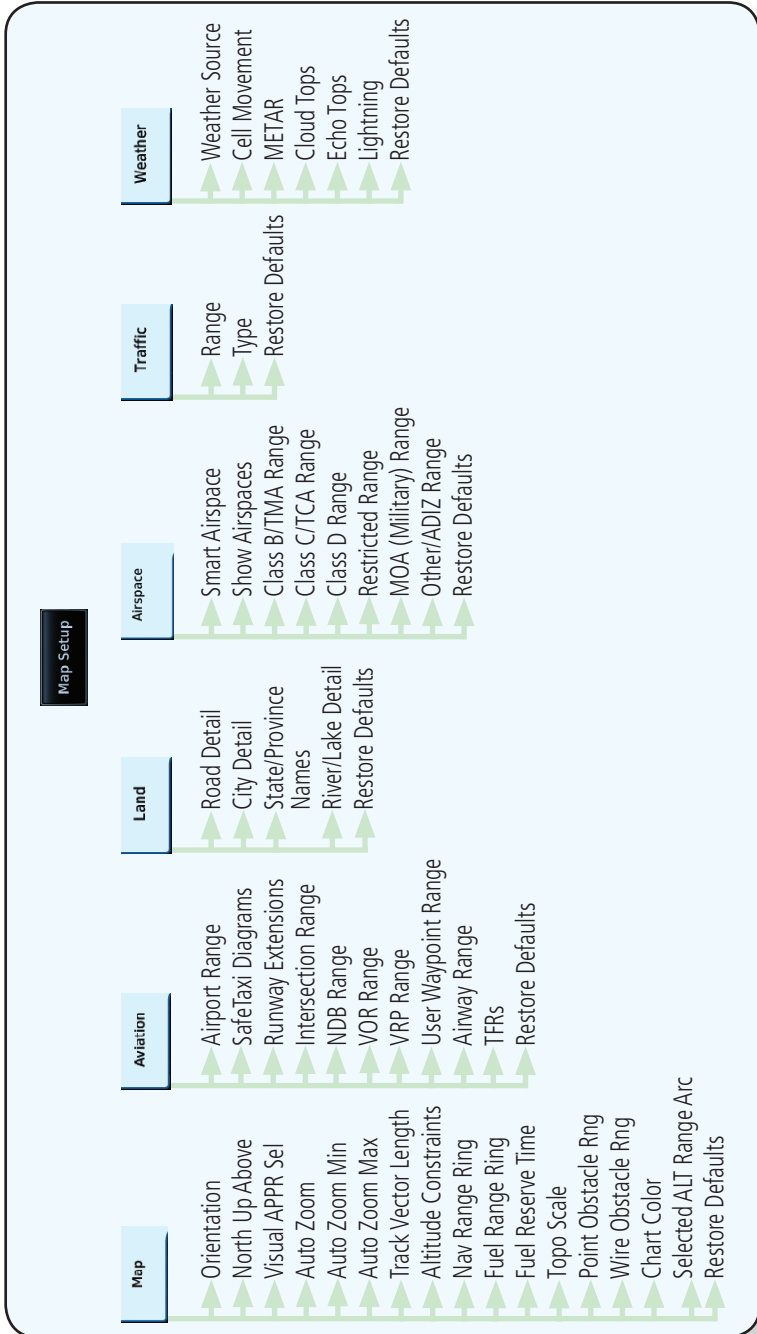

Figure 9-13 Map Setup Functional Diagram

The Map page is customized by selecting groups from the Map Menu. The Map Menu groups include choices for Map, Aviation, Land, Airspace, Traffic, and Weather groups depending on the installed equipment of a given aircraft. Each group has a list of options that vary with the group.

1. While viewing the Map page, touch the **Menu** key. Then, touch the **Map Setup** key. The Map Setup page will be displayed.

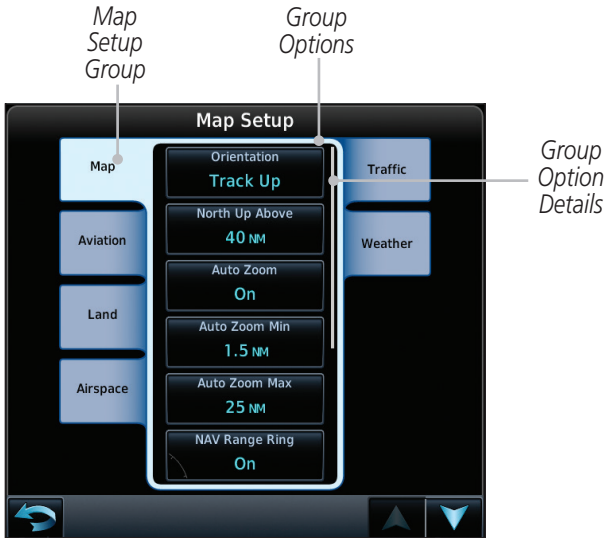

Figure 9-14 Map Setup Page

2. Touch the desired Map Setup Group tab (Map, Aviation, Airspace, Land, Traffic, or Weather) to display the set of group options.
3. Touch the desired group key. A list of options for the selected group will be shown. (i.e., Map - Orientation, North Up Above, Auto Zoom, etc.) Touch the **Up** or **Down** keys as needed to scroll through the list.
4. Touch the key for the selected option.
5. Touch the **Restore Defaults** key to return to the original default values for the selected option.



9.1.2.1 Map

The Map option defines the behavior and display of information on the Map page such as: Orientation, North Up Above, Auto Zoom, Nav Range Ring, Topo Scale, Obstacle Range, and Restore Defaults. The default values are shown in **bold** type.

Foreword
Getting Started
Audio & Xpdr Ctrl
Com/Nav
FPL
Direct-To
Proc
Charts
Wpt Info
Map
Traffic
Terrain
Weather
Nearest
Services/Music
Utilities
System
Messages
Symbols
Appendix

Feature	Selection
Orientation	North Up, Track Up , Heading Up
North Up Above	Off, 10 NM, 15 NM, 25 NM, 40 NM , 50 NM, 75 NM, 100 NM, 150 NM, 250 NM
Visual APPR Selector	Off, 2.5 NM, 4 NM, 5 NM, 7.5 NM, 10 NM , 15 NM, 25 NM
Auto Zoom	Off, On
Auto Zoom Min	250 ft, 400 ft, 500 ft, 750 ft, 1000 ft, 1500 ft, 2500 ft, 0.5 NM, 0.75 NM, 1 NM, 1.5 NM , 2.5 NM, 4 NM, 5 NM, 7.5 NM, 10 NM, 15 NM, 25 NM, 40 NM, 50 NM, 75 NM, 100 NM, 150 NM, 250 NM, 400 NM
Auto Zoom Max	250 ft, 400 ft, 500 ft, 750 ft, 1000 ft, 1500 ft, 2500 ft, 0.5 NM, 0.75 NM, 1 NM, 1.5 NM, 2.5 NM, 4 NM, 5 NM, 7.5 NM, 10 NM, 15 NM, 25 NM , 40 NM, 50 NM, 75 NM, 100 NM, 150 NM, 250 NM, 400 NM
Track Vector Length	Off, 30 SEC, 60 SEC , 2 MIN, 5 MIN, 10 MIN, 20 MIN
Altitude Constraints	Off, Selected Only, Selected & Active , All
Nav Range Ring	Off, On , Enhanced
Fuel Range Ring	Off, On
Fuel Reserve Time	30 Min, 45 Min , 60 Min, 90 Min
Topo Scale	Off , On
Point Obstacle Range	Off, 4 NM, 5 NM , 7.5 NM, 10 NM, 15 NM
Wire Obstacle Range	Off, 1 NM, 1.5 NM , 2.5 NM
Chart Color Scheme	Day , Night
Selected ALT Range Arc	Off, On
Restore Defaults	Returns values to original factory settings

Table 9-1 Map Setup Map Options

Map Orientation

The Map Orientation selection sets the orientation of the Map page. Selections are North Up, Track Up, and Heading Up. A Map Orientation label is shown below the North indicator (reference to True North) in the top left corner of the Map page.



Figure 9-15 Map Orientation Label

North Up Above

The North Up Above option allows you to select the map range where at and above the selected value the Map Orientation will automatically change to North Up as a default. When the map range is 500 NM or more, the map orientation will automatically become North Up.

Visual Approach Selector

This option allows you to select the range at which the Visual Approach Selector becomes active. When the aircraft is within a specified distance of the destination airport, the **Visual** key automatically appears in the bottom left corner of the map. Any values displaying in this area are obscured while the key is active. To disable this feature, select OFF.

For visual approach procedures, refer to section 6.13.

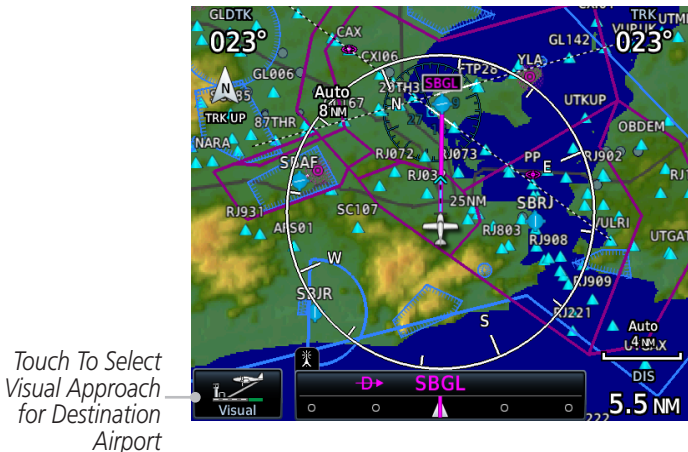

Figure 9-16 Visual Approach Key

Auto Zoom

With a valid flight plan, the Auto Zoom feature will automatically change the Map page range depending on the distance to the next waypoint in the flight plan. If enabled, it will also automatically zoom to the SafeTaxi zoom range when the aircraft is on the ground. Auto Zoom can be overridden at any time by manually zooming with the **In** and **Out** keys. The Auto Zoom Min selection sets the minimum range that the display will Zoom in. The Auto Zoom Max value sets the maximum range the display will Zoom out.



Figure 9-17 Auto Zoom Active Indication

Auto Zoom is re-enabled once one of the following conditions is met:

- A waypoint is sequenced
- The aircraft transitions from “on ground” to “in air”
- A point is reached where the Auto Zoom range matches the manual override range (known as auto-sync) and will be noted as “Auto” above the map range value on the map page
- Auto Zoom is toggled off and back on in the Map Setup page



NOTE: Rotorcraft use a Local Auto Zoom function where Auto Zoom will remain at the 1500 ft zoom scale until the rotorcraft is above 400 ft GSL or 40 kts.

Auto Zoom Min

Set the limit that the display will zoom in automatically.



Figure 9-18 Map Setup Minimum Auto Zoom Range

Auto Zoom Max

Set the limit that the display will zoom out automatically.



Figure 9-19 Map Setup Maximum Auto Zoom Range

- Foreword
- Getting Started
- Audio & Xpdr Ctrl
- Com/Nav
- FPL
- Direct-To
- Proc
- Charts
- Wpt Info
- Map**
- Traffic
- Terrain
- Weather
- Nearest
- Services/ Music
- Utilities
- System
- Messages
- Symbols
- Appendix
- Index

Track Vector



NOTE: This feature is available in software v6.20 and later.

When turned on, the track vector is depicted as a cyan line extending from the nose of the aircraft in the direction of movement. The length of the track vector represents the path the aircraft will follow if the present speed and direction are maintained for the time configured in the Track Vector Length setting.



Figure 9-20 Track Vector

Foreword

Getting Started

Audio & Xpdr Ctrl

Com/Nav

FPL

Direct-To

Proc

Charts

Wpt Info

Map

Traffic

Terrain

Weather

Nearest

Services/
Music

Utilities

System

Messages

Symbols

Appendix

Altitude Constraints



NOTE: This feature is available in software v6.50 and later.

Enabling this feature displays altitude constraints from the flight plan. The active constraint is the altitude to which VNAV is currently providing guidance. For more information about altitude constraints, refer to section 4.3.3.

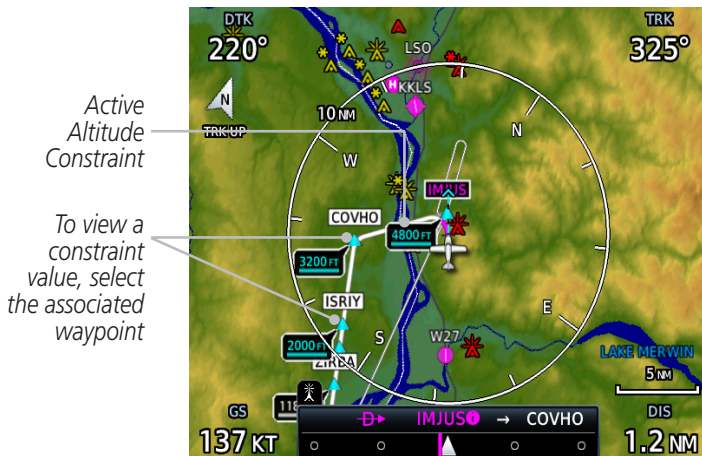

Figure 9-21 Altitude Constraints

- Foreword
- Getting Started
- Audio & Xpdr Ctrl
- Com/Nav
- FPL
- Direct-To
- Proc
- Charts
- Wpt Info
- Map
- Traffic
- Terrain
- Weather
- Nearest
- Services/Music
- Utilities
- System
- Messages
- Symbols
- Appendix

Nav Range Ring

When turned on, the Nav Range Ring option will show a ring with a compass rose oriented to magnetic north around your present position on the Map page. When selected ON, the Enhanced Range Ring function provides a second ring at 1/2 the distance of the primary ring to allow the pilot to accurately judge distance to objects depicted on the map.



Figure 9-22 Nav Range Ring

Fuel Range Ring



NOTE: This feature is available in software v6.00 and later.

When interfaced with a fuel computer, the GTN can display a Fuel Range Ring which shows an estimate of the remaining flight distance at the current fuel consumption rate and groundspeed. If either fuel quantity or fuel flow sensor data is not received, the GTN will use the Fuel on Board or Fuel Flow values on the Utilities – Fuel Planning page. If both fuel quantity and fuel flow are not received by the GTN, the Fuel Range Ring will be removed. A dashed green circle indicates the selected Range to Reserve Fuel. A solid yellow circle indicates the Total Endurance Range.

- Foreword
- Getting Started
- Audio & Xpdr Ctrl
- Com/Nav
- FPL
- Direct-To
- Proc
- Charts
- Wpt Info
- Map
- Traffic
- Terrain
- Weather
- Nearest
- Services/Music
- Utilities
- System
- Messages
- Symbols
- Appendix



TOPO Scale

The Topo Scale option selects whether the elevation scale for topographical features on the Map page is displayed. The scale will be located on the left side of the display.

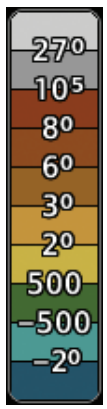

Figure 9-24 Map Page Topo Scale

Point Obstacle Range

The Point Obstacle Range option selects whether the Point Obstacle Data is shown on the Map page at and below the selected Point Obstacle range. Map ranges above this value will not show the Point Obstacle Data. An obstacle with an asterisk indicates a group of the same obstacle type.





Unlighted Obstacle (Height is less than 1000 ft AGL)	Lighted Obstacle (Height is less than 1000 ft AGL)	Unlighted Obstacle (Height is greater than 1000 ft AGL)	Lighted Obstacle (Height is greater than 1000 ft AGL)
			

Table 9-2 Navigation Map Point Obstacle Icons by Elevation





Tower	Windmill	Windmill in Group	Power Line
			

Table 9-3 Obstacle Icon Types

Color	Description
None	Lines are removed when they are more than 2000 ft below the aircraft.
White	Lines are white when they are within 2000 ft below the aircraft.
Amber	Lines are amber when they are within 1000 ft below the aircraft.
Red	Lines are red when they are within 100 ft below or above the altitude of the airplane.

Table 9-4 Fixed Wing Color Scheme for Obstacles and Wires

Color	Description
None	Lines are removed when they are more than 500 ft below the rotorcraft.
White	Lines are white when they are within 500 ft below the rotorcraft.
Amber	Lines are amber when they are within 250 ft below the rotorcraft.
Red	Lines are red when they are at or above the altitude of the rotorcraft.

Table 9-5 Rotorcraft Color Scheme for Obstacles and Wires

Grouped obstacles are shown with an asterisk. The color of the asterisks is tied to the relative altitude of the highest obstacle in the group, not other obstacles within that group. Obstacles are grouped when they would otherwise overlap.



1. While viewing the Map function, touch the **Menu** key.

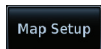

2. Touch the **Map Setup** key.



3. Under the **Map** tab touch the **Point Obstacle Range** key and select the maximum range where obstacles will be displayed.



Unlighted Obstacle

Lighted Obstacle

Grouped Obstacles

Current Position

Active Obstacle Overlay Types *

Figure 9-25 Navigation Map Point Obstacles

* The icon on the left shows that the point obstacle overlay is active. The icon on the right shows that the wire obstacle overlay is active. These icons are available in software v5.12 or later.



4. Touch an obstacle on the map and the elevation will be shown. If there are nearby or overlaid objects (obstacle, airspace, airport, etc), touch the **Next** key to step through the nearby objects. Touch the **Back** key to return to the normal map view.



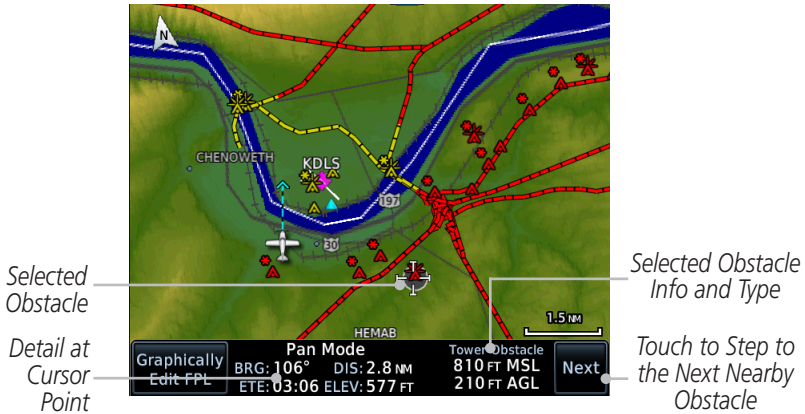

Figure 9-26 Point Obstacle Detail

Wire Obstacle Range

The Wire Obstacle Range option selects whether the power lines are shown on the Map page at and below the selected Wire Obstacle range. Map ranges above this value will not show the Wire Obstacle Data.



NOTE: This feature is available in software v5.10 and later and requires the use of obstacle databases that contain wire obstacle data.



Figure 9-27 Wire Obstacles

Chart Color Scheme

The Chart Color Scheme setting changes the day and night view of the Chart Overlay colors on the Map page.

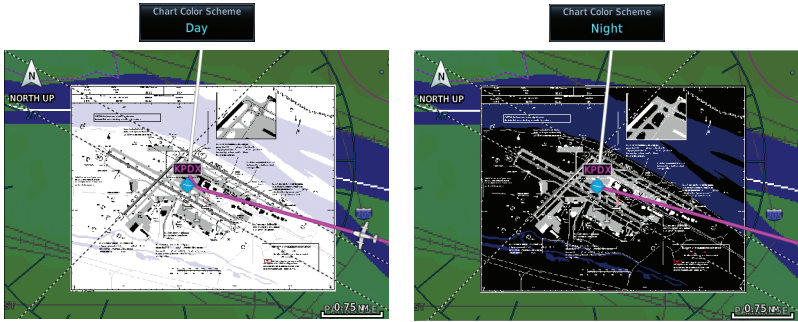

Figure 9-28 Chart Color Scheme Settings

Selected Altitude Range Arc



NOTE: Requires a Garmin Display Unit (GDU). This feature is available in software v6.60 and later.

Enabling the Selected ALT Range Arc setting places a cyan arc in front of the aircraft symbol. This arc represents the location at which the aircraft is expected to reach the selected altitude.

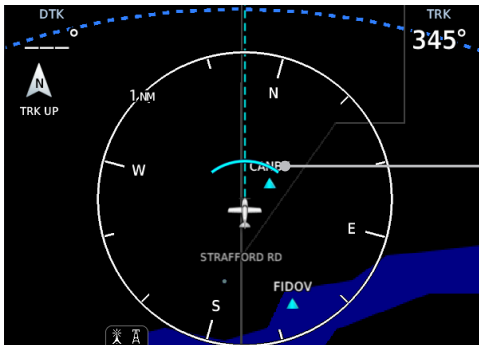

Figure 9-29 Selected ALT Range Arc

Restore Defaults

Returns values to the original factory settings.

9.1.2.2 Aviation

The Aviation group selection from the Map Setup Page Menu allows you to customize the display of Active Flight Plan, Active Flight Plan Waypoints, Airport size range, SafeTaxi information, Runway Extensions, Intersection/NDB locations, VOR locations, Airspace Detail, and TFR icons on the Map page. The feature will be shown at map ranges of the selected value and lower. The options for each feature are shown in the following table. The default values are shown in **bold** type.

Feature	Selection
Airport Range	Off, 7.5 NM, 10 NM, 15 NM, 25 NM , 40 NM, 50 NM, 75 NM, 100 NM, 150 NM
Heliports (Optional)	Off, On
SafeTaxi Diagrams	Off, 1000 ft, 1500 ft, 2500 ft, 0.5 NM, 0.75 NM, 1 NM , 1.5 NM
Runway Extensions	Off, 1 NM, 1.5 NM, 2.5 NM, 4 NM, 5 NM
Intersection Range	Off, 0.75 NM, 1 NM, 1.5 NM, 2.5 NM, 4 NM , 5 NM, 7.5 NM, 10 NM
NDB Range	Off, 0.75 NM, 1 NM, 1.5 NM, 2.5 NM, 4 NM, 5 NM , 7.5 NM, 10 NM
VOR Range	Off, 10 NM , 15 NM, 25 NM, 40 NM, 50 NM, 75 NM, 100 NM
VRP Range	Off, 0.74 NM, 1 NM, 1.5 NM, 2.5 NM, 4 NM , 5 NM, 7.5 NM, 10 NM
User Wpt Range	Off, 0.75 NM, 1 NM, 1.5 NM, 2.5 NM, 4 NM, 5 NM , 7.5 NM, 10 NM, 15 NM, 25 NM, 40 NM, 50 NM, 75 NM, 100 NM
Airway Range	2.5 NM, 4 NM, 5 NM, 7.5 NM, 10 NM, 15 NM, 25 NM
TFR	Off , On
Restore Defaults	Returns values to original factory settings

Table 9-6 Map Setup Aviation Options



NOTE: The term “intersection range” means any GPS waypoint included in the navigation database, and includes waypoints that may not be intersections of two VOR radials.

Airport Size	Size Criteria	Display Criteria
Small	Longest runway length is less than 5,000 feet, unless it has a tower frequency, in which case it is a Medium Airport.	Small airports and heliports are displayed on the map when the Map Range is less than or equal to 1/4 times the Airport Range Setting.
Medium	Longest runway length is less than 8,100 feet but greater than or equal to 5,000 feet or less than 8,100 feet and has a tower frequency.	Medium airports are displayed on the map when the Map Range is less than or equal to 1/2 times the Airport Range Setting.
Large	Longest runway length is greater than or equal to 8,100 feet.	Large airports are displayed on the map when the Map Range is less than or equal to the Airport Range Setting.

Table 9-7 Airport Display Range Setting



NOTE: The Airport Range Setting of "Off" means airports are never displayed. Heliports are displayed on the map page if the Heliport Display Setting is "On" and the Map Range is less than or equal to 1/4 times the Airport Range Setting.

9.1.2.3 Land

The Land Data option selects whether detailed land features, such as Freeways, National Highways, Local Roads, Cities, States/Provinces, and Rivers/Lakes are displayed. Topo features, traffic, terrain, and obstacles will still be displayed, even with Land Data turned off. The options for each feature are shown in the following table. The default values are shown in **bold** type.

Feature	Selection
Road Detail	None, Least, Less, Normal , More, Most
City Detail	None, Least, Less, Normal , More, Most
State/Province Names	Off, On
River/Lake Detail	None, Least, Less, Normal , More, Most
Restore Defaults	Returns values to original factory settings

Table 9-8 Map Setup Land Options

9.1.2.4 Airspace

The Airspace viewing range options select whether the Airspaces are shown on the Map and at and below the selected map ranges. The Smart Airspaces selection filters airspaces to show the ones appropriate for your altitude.

Feature	Selection
Airspace Label Range	Off, 7.5 NM, 10 NM, 15 NM, 25 NM , 40 NM, 50 NM
Smart Airspace	Off , On
Show Airspaces	All , Below 18000 ft, Below 15000 ft, Below 12000 ft, Below 9000 ft, Below 6000 ft, Below 3000 ft
Class B/TMA Range	Off, 7.5 NM, 10 NM, 15 NM, 25 NM, 40 NM, 50 NM, 75 NM, 100 NM , 150 NM
Class C/TCA Range	Off, 7.5 NM, 10 NM, 15 NM, 25 NM, 40 NM , 50 NM, 75 NM, 100 NM, 150 NM
Class A/D Range	Off, 7.5 NM, 10 NM, 15 NM , 25 NM, 40 NM, 50 NM, 75 NM, 100 NM, 150 NM
Restricted Range	Off, 7.5 NM, 10 NM, 15 NM, 25 NM, 40 NM, 50 NM, 75 NM, 100 NM, 150 NM
MOA (Military) Range	Off, 7.5 NM, 10 NM, 15 NM, 25 NM, 40 NM , 50 NM, 75 NM, 100 NM, 150 NM
Other/ADIZ Range	Off, 7.5 NM, 10 NM, 15 NM, 25 NM, 40 NM, 50 NM, 75 NM, 100 NM, 150 NM
Restore Defaults	Returns values to original factory settings

Table 9-9 Map Setup Airspace Options

- Foreword
- Getting Started
- Audio & Xpdr Ctrl
- Com/Nav
- FPL
- Direct-To
- Proc
- Charts
- Wpt Info
- Map**
- Traffic
- Terrain
- Weather
- Nearest
- Services/ Music
- Utilities
- System
- Messages
- Symbols
- Appendix

Airspace Labels



NOTE: This feature is available in software v5.10 and later when configured by the installer.

The Airspace Label feature shows the United States airspace system altitude limits up to the selected range.



Airspace Labels - On

Figure 9-30 Display of Airspace Labels

Smart Airspaces

Garmin's Smart Airspace™ feature aids visual clarity on-screen by de-emphasizing airspace that's well above or below the aircraft's current altitude. The vertical separation is 1,000 feet at sea level and the vertical separation will gradually increase to 2,000 feet until the aircraft reaches 10,000 feet. Anything above 10,000 feet keeps the 2,000 feet vertical separation.



NOTE: Smart Airspace only changes the depiction of the airspace on the moving map display. It does not alter the Airspace Alerts that can be set on the System-Alerts portion of the system.

Smart Airspaces - Off

Smart Airspaces - On



Figure 9-31 Display of Smart Airspaces (Airspace Borders Grayed)

To control the display of European airway airspaces:

OTHER/ADIZ Range
25 NM

1. While viewing the Map Setup Airspaces option, touch the **Other/ADIZ Range** key and select a value.

OTHER/ADIZ Range
Off

2. Select **Off** for the Other/ADIZ Range to turn off the display of airway airspaces.



Airway Airspaces - Off



Airway Airspaces - On

Airway Airspaces - On

Figure 9-32 Selecting the Display of European Airway Airspaces

Foreword

Getting Started

Audio & Xpdr Ctrl

Com/Nav

FPL

Direct-To

Proc

Charts

Wpt Info

Map

Traffic

Terrain

Weather

Nearest

Services/
Music

Utilities

System

Messages

Symbols

Appendix

9.1.2.5 Airway Range

The Airways viewing range option selects whether the Airways are shown on the Map and at and below the selected map ranges for Low and High Airways. When Off is selected, the information will not be shown.



1. While viewing the Map function, touch the **Menu** key.

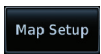

2. Touch the **Map Setup** key and then with the **Aviation** tab highlighted drag the list down or use the Down key to show the Airway Range.



Figure 9-33 Map Setup for Airway Range



3. Touch the **Airway Range** key and select a range.

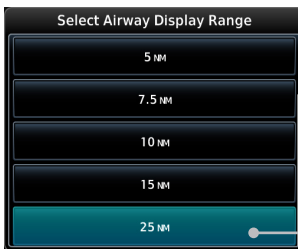

Selected Airway Display Range

Figure 9-34 Select Airway Display Range

9.1.2.6 Traffic (Optional)

The Traffic group selection from the Map Setup Page Menu allows you to customize the display of traffic on the Map page. The Traffic function requires the installation of the appropriate traffic device. Only one traffic source can be configured for the GTN and this traffic source will be overlaid on the main map. Coverage follows the airplane. In the Navigation Map page setup you can select the maximum range at which traffic symbols are shown. Once outside of the selected range, traffic will be decluttered. The default values are shown in **bold** type.

Traffic Selection	Display Result
Range	1 NM, 1.5 NM, 2.5 NM, 4 NM, 5 NM, 7.5 NM, 10 NM, 15 NM, 25 NM
Traffic	All Traffic , Alerts & Advisories, Alerts Only
Restore Defaults	Returns values to original factory settings

Table 9-10 Map Page Traffic Display Options

- Foreword
- Getting Started
- Audio & Xpdr Ctrl
- Com/Nav
- FPL
- Direct-To
- Proc
- Charts
- Wpt Info
- Map**
- Traffic
- Terrain
- Weather
- Nearest
- Services/ Music
- Utilities
- System
- Messages
- Symbols
- Appendix

9.1.2.7 Weather (Optional)

The Weather group selection from the Map Setup Page Menu allows you to customize the overlay of the available weather information on the Map page. Weather is an optional feature that requires an external weather source, which must be selected to allow the overlay.

Feature	Selection
Weather Source	SiriusXM, Connxt, or FIS-B
Cell Movement	Off , On
METAR	Off , On
Cloud Tops	Off , On
Echo Tops	Off , On
Lightning	Off , On
Restore Defaults	Returns values to original factory settings

Table 9-11 Map Setup SiriusXM Weather Options

NOTE: Map overlay keys may remain available even if the information necessary for the overlay is not available. For example: the Radar overlay key is available even if the radar is turned off.

Feature	Selection
Weather Source	SiriusXM, Connxt, or FIS-B
METAR	Off , On
IR Satellite	Off , On
Lightning	Off , On
Restore Defaults	Returns values to original factory settings
Connxt Settings	Selectable Connxt Settings

Table 9-12 Map Setup Connxt Weather Options

Feature	Selection
Weather Source	SiriusXM, Connxt, or FIS-B
METAR	Off , On
Restore Defaults	Returns values to original factory settings

Table 9-13 Map Setup FIS-B Weather Options

9.1.3 Change User Fields

The Change User Fields selection allows you to configure the Data, Function, and Page field type shown in each of the four corners of the Map page. The information shown in each field may be selected from a list after Change User Fields is selected.



1. While viewing the Map page, touch the **Menu** key.



2. From the Map Menu screen, touch the **Change User Fields** key.



Touch To Select Data Field (TRK Currently Shown)

Touch To Select Data Field (DIS Currently Shown)

Touch To Save Any Changes

Figure 9-35 Map Data Fields Selection



NOTE: Map Data Field Types that use the term "Destination" refer to the missed approach point (if an approach is loaded) or the final airport in the flight plan.



NOTE: In software v5.13 and earlier, ETE to Destination is not available when a procedure is loaded and there are waypoints in the En Route section of the flight plan.

3. Touch the corner data field key you want to select. Touch the **Data**, **Function**, or **Page** keys to select the User Field type. A list of information types will be displayed.

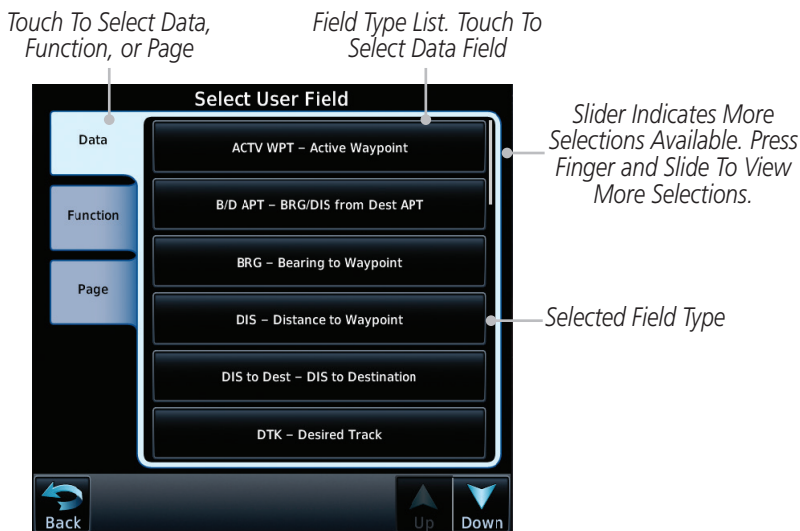

Figure 9-36 Map Data Field Type Selections



4. Touch the **Up** or **Down** keys or touch the display and drag your finger to scroll through the list. Touch the desired item to select it or touch the **Back** key to cancel selection.

Map Data Field Type	
ACTV WPT - Active Waypoint	MSA - Minimum Safe Altitude
B/D APT - BRG/DIS from Dest APT ¹	OAT (static) - Static Air Temperature
BRG - Bearing to Current Waypoint	OAT (total) - Total Air Temperature
DIS - Distance to Current Waypoint	RAD ALT - Radar Altimeter
DIS to Dest - Distance to Destination ²	Time - Current Time
DTK - Desired Track	Time to TOD - Time to Top of Descent
ESA - Enroute Safe Altitude	TKE - Track Angle Error
ETA - Estimated Time of Arrival	TRK - Track
ETA at Dest - ETA at Destination	Trip Timer - Timer Display
ETE - Estimated Time Enroute	VOR/LOC - Tuned VOR/LOC Info
ETE to Dest - ETE to Destination	VSR - Vertical Speed Required
Fuel Flow - Total Fuel Flow	Wind - Wind Speed and Direction
GS - GPS Ground Speed	XTK - Cross Track Error
GSL - GPS Altitude	OFF - Do Not Display Data Field
Generic Timer - Timer Display	

Table 9-14 Map Data Field Types of Information

Note 1: B/D APT is the straight line distance.

Note 2: Dist to DEST is the distance along the flight plan.

Function Field Type	
CDI - Course Deviation Indicator	Passenger Address - PA Toggle
Flap Override - Flap Override ¹	Playback - Play Last Recording
GPWS Inhibit - GPWS Inhibit ¹	TAWS Inhibit - TAWS Inhibit
G/S Inhibit - G/S Inhibit ¹	Gen Timer - Generic Timer Control
HTAWS RP Mode - HTAWS RP Mode ²	WX RDR Controls - Weather Radar Controls
OBS/Suspend/Unsuspend Button	OFF - Do Not Display Data Field
On Scene - "On Scene" Mode Toggle	

Table 9-15 Map Function Field Types of Information

Note 1: With TAWS-A enabled

Note 2: With HTAWS enabled

Map Page Field Type		
Foreword	Blackout Mode	Checklist - Checklist Page
Getting Started	Charts - Charts Page	Fuel PLAN - Fuel Planning Page
Audio & Xpdr Ctrl	Flight Plan - Flight Plan Page	SCHEd MSG - Scheduled Messages
	Map - Map Page	Trip PLAN - Trip Planning Page
Com/Nav	Nearest - Nearest Page	VcALC - VcALC Page
	NEAR APT - Nearest Airport Page	User FREQ - User Frequencies
FPL	PROC - Procedures Page	WPT INFO - Waypoint Information
Direct-To	Approach - Approach Page	Weather - Weather Page
	Arrival - Arrival Page	CNXT WX - ConnexT WX Page
Proc	Departure - Departure Page	FIS-B WX - FIS-B Weather Page
	Backlight - Backlight Page	Stormscope - Stormscope Page
Charts	Services - Services Page	WX Radar - Weather Radar Page
	Traffic - Traffic Page	SiriusXM WX - Sirius XM WX Page
Wpt Info	Terrain - Terrain Page	OFF - Do Not Display Page Field
	Utilities - Utilities Page	

Table 9-16 Map Page Field Types of Information

Traffic

Terrain

Weather

Nearest

Services/
Music

Utilities

System

Messages

Symbols

Appendix

9.1.4 Map Detail

The Map Detail feature allows four levels of decluttering to remove map information. Level 0 shows the most detail and level 3 shows the least detail.

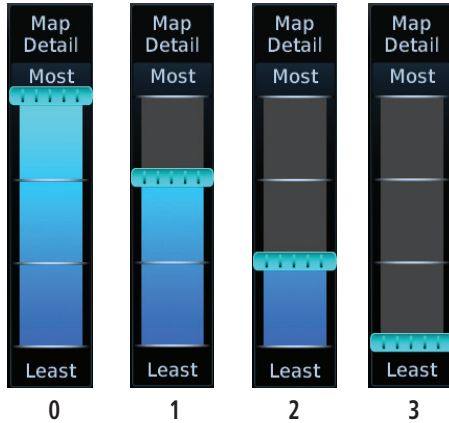

Figure 9-37 Map Detail Levels



1. While viewing the Map page, touch the **Menu** key.
2. While viewing the Map Menu, touch the **Map Detail** scale and slide your finger to adjust the level. Features marked with a • are shown at the indicated Map Detail Level.

	Feature	0	1	2	3	Feature	0	1	2	3
Foreword	River/Lake Names	•				TRSA	•	•		
Getting Started	Land/Country Text	•				ADIZ	•	•		
Audio & Xpdr Ctrl	Large City	•				Alert Areas	•	•		
	Medium City	•				Caution Areas	•	•		
	Small City	•				Danger Areas	•	•		
Com/Nav	Small Town	•				Warning Areas	•	•		
	Freeways	•				Large Airports	•	•	•	
FPL	Highways	•				Medium Airports	•	•	•	
Direct-To	Roads	•				Restricted Areas	•	•	•	
	Railroads	•				Prohibited Areas	•	•	•	
Proc	Political Boundaries	•				MOAs	•	•	•	
Charts	User Waypoints	•	•			Runway Labels	•	•	•	
	VORs	•	•			Lightning Strike Data	•	•	•	
Wpt Info	NDBs	•	•			NEXRAD Data	•	•	•	
Map	Intersections	•	•			Traffic Symbols	•	•	•	
	Class B Airspace	•	•			Traffic Labels	•	•	•	
	Class C Airspace	•	•			Water Detail	•	•	•	•
Traffic	Class D Airspace	•	•			Active FPL Legs	•	•	•	•
	Tower	•	•			Airways	•	•	•	•

Table 9-17 Features Shown at Each Map Detail Level

Weather

Nearest

Services/
Music

Utilities

System

Messages

Symbols

Appendix

9.2 Map Panning

In the Map Page function, panning allows you to move the map beyond its current limits without adjusting the map scale. The panning function is selected by simply touching the Map display. The **In** and **Out** keys at the lower right corner of the page control the map range. Touching the display momentarily switches the display to Map Pan Mode. While in Map Pan Mode, touch the display gently and drag your finger to pan around the map.

1. Touch the Map page display.

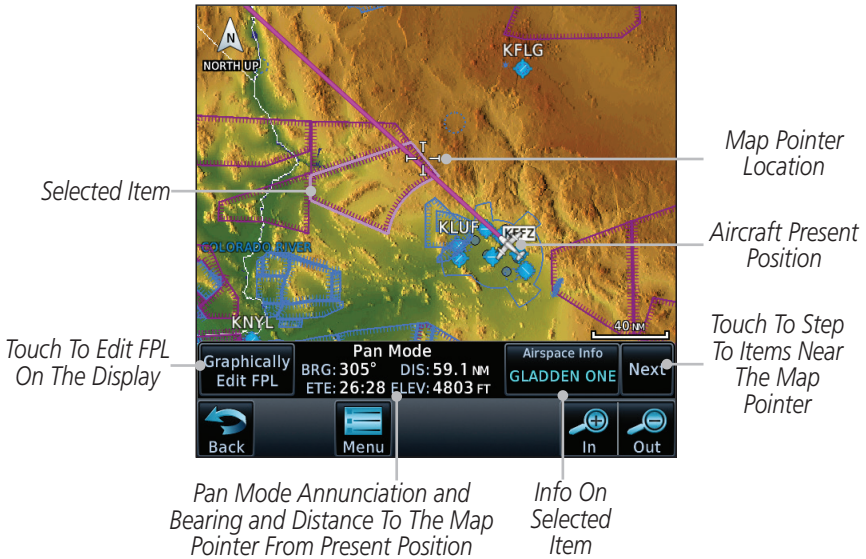

Figure 9-38 Map Panning With Airspace Highlighted



NOTE: It is possible that multiple airspaces can be stacked vertically and be difficult to visually identify them. Touching the **Next** key will step through the airspaces.

Next

- If you touch an item on the display (waypoint, airspace, obstacle) there may be other items very close that are difficult to see at a given zoom level. Touch the **Next** key to annunciate and highlight the next item. Each touch of the **Next** key steps to another item near the Map Pointer.

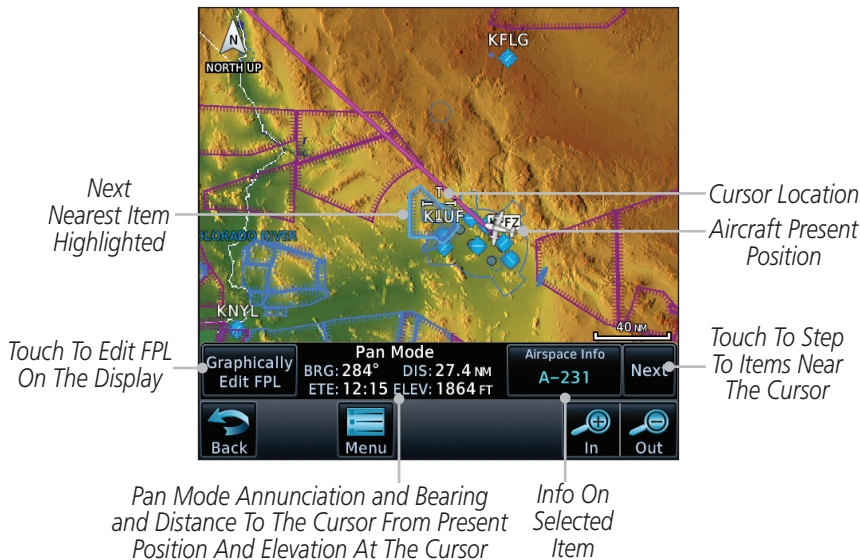

Figure 9-39 Map Panning With Next Airspace Shown

Airspace Info
A-231

- Touch the **Airspace Info** (Item) key for more information about the selected item. Touch the **Back** key to return to the Map Panning display.



Figure 9-40 Map Panning Selected Item Information

4. While pressing your finger gently against the display, drag your finger across the display to scroll the display in the direction of your finger movement. The Map Pointer cross hair location is based on where your finger touches the display, but after dragging your finger the Map Pointer will be centered on the map when your finger is lifted from the display.



Figure 9-41 Map Panning With Map Pointer



NOTE: Pressing the Direct-To key will use the Map Pointer location as the destination.



5. Touch the **Back** key to return to the normal map display.

9.3 Map Controls

While in the Map page function, several controls are available to manage the view and display of information. The **In** and **Out** keys at the lower right corner of the page control the map range. Touching the display momentarily switches the display to Map Pan Mode.

While in any of the Map function pages, touching the display starts **Pan Mode**. Options are available to Create a waypoint at the Map Pointer position and to Graphically Edit Flight Plan.

9.3.1 Pan Map Mode

The Pan Map mode allows you to move the map display to view the surrounding area.

1. Touch the Map page display.
2. See the description in the Map Panning section for details of using this feature. Touch the **Back** key to return to the normal Map display.



9.3.2 Create Waypoint

The Create Waypoint function will create a User Waypoint at the Map Pointer location when that location is not an already named object, such as an airport or airspace.

1. In Pan Mode, touch the **Create Waypoint** key.
2. Follow the directions in the Waypoint Info section for Creating User Waypoints.



Figure 9-42 Create User Waypoint While Map Panning

9.3.3 Graphically Edit Flight Plan Mode

The Edit Flight Plan Mode allows making quick changes to the active flight plan directly on the display. The process is simply touching the display to start Map Pan Mode, touching the **Graphically Edit FPL** key, dragging the desired leg to a new waypoint or airway, and touching the **Done** key. When graphically editing the active flight plan leg, the active leg course and TO Waypoint will be added to the flight plan as a Direct-To. At any point, a step may be removed by touching the **Undo** key or the whole process ended by touching the **Cancel** key. The **Undo** key will remove up to nine steps.



NOTE: It is not possible to graphically add an intermediate waypoint between the current position and a Direct-To waypoint unless that waypoint is in the flight plan. Garmin recommends deleting any flight plan prior to graphically editing a Direct-To waypoint.

9.3.3.1 Adding a Waypoint Within an Existing Flight Plan

Graphically Edit FPL

1. Touch the Map page display. The Map Mode selection keys will appear. Touch the **Graphically Edit FPL** key.

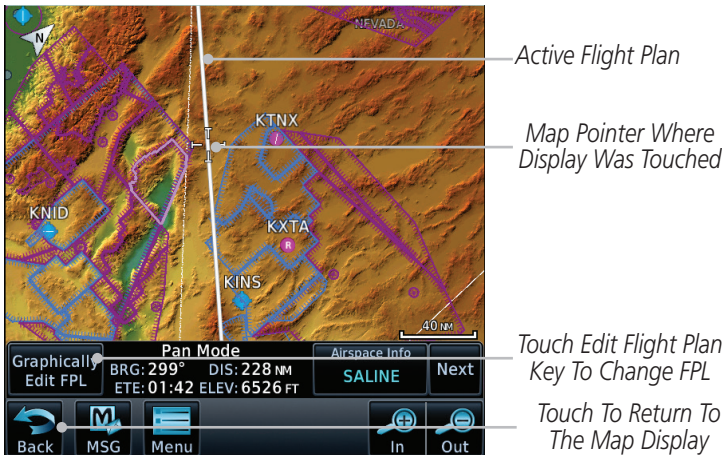

Figure 9-43 Edit Flight Plan Mode

2. Touch and hold the desired leg of the flight plan.

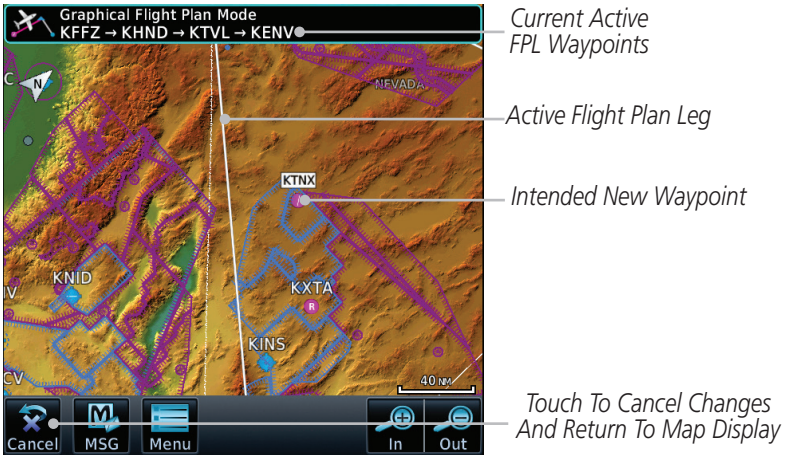

Figure 9-44 Select Leg of Flight Plan to Change

3. Drag the flight plan leg to a new waypoint, or airway, to add a waypoint, or airway, to the active flight plan. The flight plan leg being edited will turn cyan.

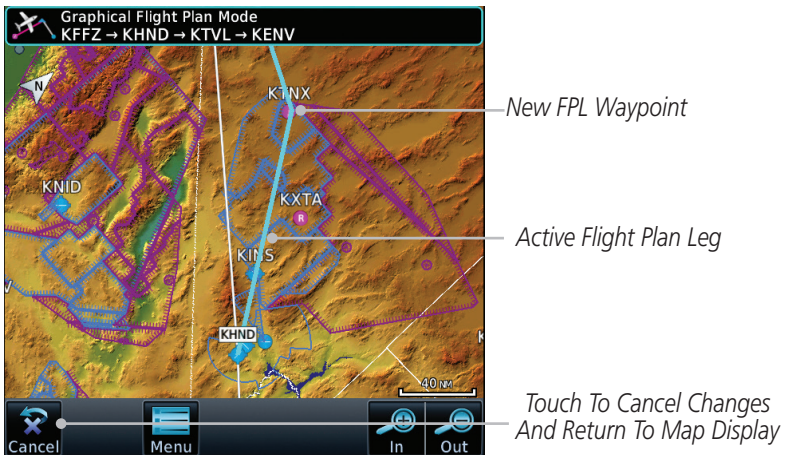

Figure 9-45 Drag Selected Leg of Flight Plan to New Waypoint

- Foreword
- Getting Started
- Audio & Xpdr Ctrl
- Com/Nav
- FPL
- Direct-To
- Proc
- Charts
- Wpt Info
- Map
- Traffic
- Terrain
- Weather
- Nearest
- Services/Music
- Utilities
- System
- Messages
- Symbols
- Appendix

Done

4. Touch the **Done** key. The aircraft will now navigate according to the new flight plan.

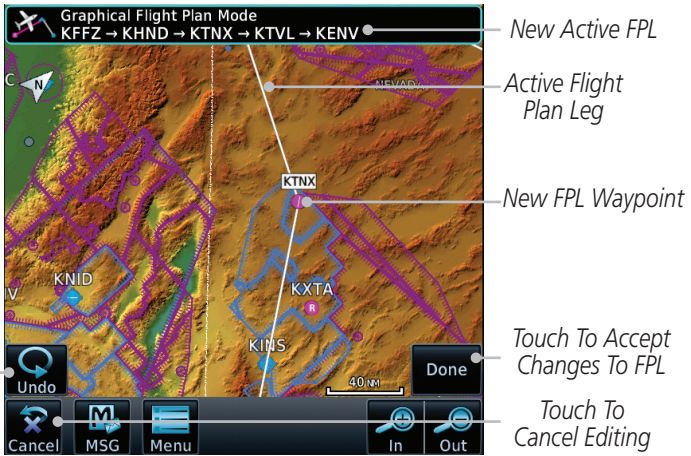

Figure 9-46 Completed Flight Plan with New Waypoint



NOTE: In software v6.21 and earlier, graphically editing a flight plan cancels the parallel track function.

9.3.3.2 Adding a Waypoint to the End of an Existing Flight Plan

Graphically Edit FPL

1. Touch the Map page display. The Map Mode selection keys will appear. Touch the **Graphically Edit FPL** key.
2. Touch a waypoint that you want to add to the end of the flight plan.
3. Touch the **Done** key to accept the changes and return to the Map page.

Done

9.3.3.3 Removing a Waypoint from an Existing Flight Plan

Graphically Edit FPL

1. Touch the Map page display. The Map Mode selection keys will appear. Touch the **Graphically Edit FPL** key.
2. Touch a waypoint, or airway, on the flight plan that you want to remove.
3. Drag the flight plan line away from the waypoint, or airway, and release the line. The waypoint, or airway, will be removed from the flight plan.
4. Touch the **Done** key to accept the changes and return to the Map page.

Done

9.3.3.4 Creating a Flight Plan Without an Existing Flight Plan

Graphically Edit FPL

1. Touch the Map page display. The Map Mode selection keys will appear. Touch the **Graphically Edit FPL** key.
2. Touch a waypoint on the map to set the first waypoint in the flight plan. If there are several nearby waypoints, touch the desired waypoint to select it.

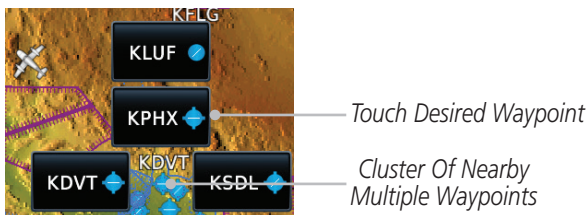

Figure 9-47 Select the Desired Waypoint From Multiple Waypoints

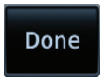

Figure 9-48 Start New Flight Plan with Origin Waypoint

3. Touch a waypoint, or airway, on the map for the next waypoint, or airway, in the flight plan. Continue adding waypoints, or airways, as needed.



Figure 9-49 Add New Waypoint to Flight Plan



4. Touch the **Done** key to accept the changes and return to the Map page.

9.4 CDI (GTN 750 only)

The GTN 750's **CDI** key is used to select data that is sent from the GPS or VLOC receiver to the external CDI (or HSI). When the external CDI (or HSI) is connected to the GPS receiver, “GPS” appears below the **CDI** key in the annunciation bar. When the external CDI (or HSI) is being driven by the VLOC receiver, “VLOC” appears instead.



NOTE: The VLOC receiver must be selected for display on the external CDI/HSI for approaches which are not approved for GPS. See the ILS example in the Procedures section for more information.



NOTE: GPS phase of flight annunciations (LPV, ENR, etc.) are not applicable to the external CDI (or HSI) when VLOC is active.



NOTE: The internal on-screen CDI information is based on GPS data and cannot be used for primary navigation.



NOTE: If the unit is not configured for a CDI key, then the “activate GPS missed approach” will only resume automatic waypoint sequencing. The user must switch to GPS navigation, if desired, by using their external source selection method (this is typical an EFIS system).

1. The navigation source is annunciated under the **CDI** key.



Touch **CDI** Key To Toggle Navigation Source

Navigation Source Annunciation

Figure 9-50 Navigation Source Selection

2. Touch the **CDI** key to toggle between sources.

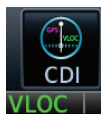

9.5 OBS

The **OBS** key is used to select manual or automatic sequencing of waypoints. Touching this key selects OBS mode, which retains the current “active to” waypoint as your navigation reference even after passing the waypoint (i.e., prevents sequencing to the next waypoint). Touching the **OBS** key again returns to normal operation, with automatic sequencing of waypoints. Whenever OBS mode is selected, you may set the desired course To/From a waypoint using the pop-up window on the GTN 7XX or with the external OBS selector on your HSI or CDI. For leg types that do not support OBS, this key will be shown as a **SUSP** key. This key will then also function as an **Unsuspend** key for legs that auto-suspend, such as holds, missed approaches, etc.



NOTE: In dual GTN installations with crossfill on, the OBS course will only be updated real time on the GTN that is receiving the new OBS course. The course will be transferred to the other GTN when OBS is exited.



1. Touch the **OBS** key to enable the OBS function.
2. Enter the desired OBS heading using the keypad and touch **Enter**.
3. The OBS heading will be shown in the flight plan annunciation above the CDI in the lower portion of the display. The OBS function annunciation will show.

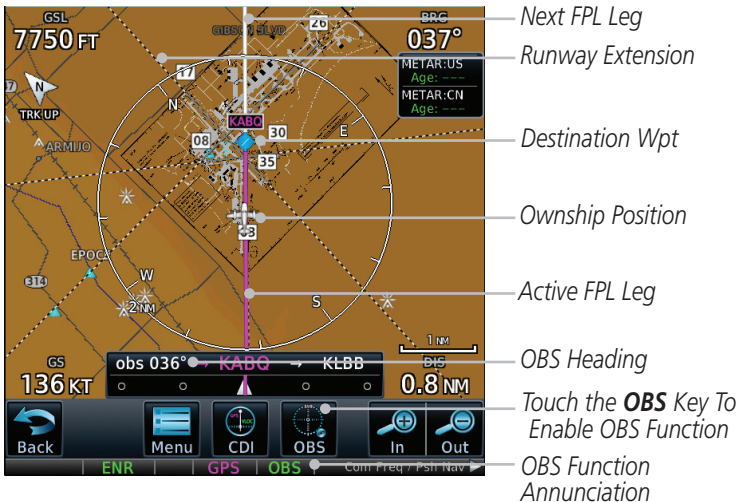

Figure 9-51 OBS Course Selection

9.6 Map Symbols

Various symbols are used to distinguish between waypoint types. The identifiers for any on-screen waypoints can also be displayed. Special-use and controlled airspace boundaries appear on the map, showing the individual sectors in the case of Class B, Class C, or Class D airspace. The following symbols are used to depict the various airports and nav aids on the Map Page.





















Symbol	Description	Symbol	Description
	Airport with hard surface runway(s); Non-Serviced, Primary runway shown		Airport with hard surface runway(s); Serviced, Primary runway shown
	Airport with soft surface runway(s) only, Non-Serviced		Airport with soft surface runway(s) only, Serviced
	Restricted (Private) Airfield		Unknown Airport
	Heliport		NDB
	Intersection		Locator Outer Marker
	VOR		VOR/DME
	VORTAC		DME
	TACAN		TOD/BOD
	User Waypoint		User Airport
	ATK		VRP

Table 9-18 Map Symbols

9.7 Flight Plan Depiction

When a flight plan is present, it will be depicted on the GTN maps.

Flight plan leg colors are used to indicate past, active, or future flight plan segments. A thin light gray line indicates a previous flight plan segment. A bold magenta line indicates an active flight plan segment for which the navigator is providing guidance. A bold white line indicates future flight plan segments. Missed approach procedures are depicted with a thin white line to indicate that they are an upcoming segment of the flight plan, but will not become navigable without the pilot specifically activating the missed approach procedure.

Flight plan labels are white boxes with black borders and black text to indicate they are fixes in the flight plan. If the waypoint is the active waypoint in the flight plan, the border and text are magenta.

All holding patterns and procedure turns are depicted with the same coloration as all other flight plan segments. Entries are depicted with segmented arrows to indicate which direction in which the course guidance will be given. This is used for both hold entry and procedure turn course reversals. Once a hold becomes active the entry guidance is removed from the map and only the active hold is depicted.

Headings to fly are depicted as directional arrows with spaces between them and the label “Vectors” or “MANSEQ” to indicate what the pilot might expect while flying the heading depicted. “MANSEQ” is “Manual Sequencing” abbreviated and denotes that the procedure is complete upon reaching that heading and that no other guidance will be given from the navigator without pilot interaction.

The following illustrates the flight plan segments as presented on the GTN maps.

Foreword

Getting Started

Audio & Xpdr Ctrl

Com/Nav

FPL

Direct-To

Proc

Charts

Wpt Info

Map

Traffic

Terrain

Weather

Nearest

Services/ Music

Utilities

System

Messages

Symbols

Appendix

GTN provides guidance in the hold at WIGAN intersection.

- Foreword
- Getting Started
- Audio & Xpdr Ctrl
- Com/Nav
- FPL
- Direct-To
- Proc
- Charts
- Wpt Info
- Map
- Traffic
- Terrain
- Weather
- Nearest
- Services/ Music
- Utilities
- System
- Messages
- Symbols
- Appendix



Figure 9-52 Active Hold

In this case the teardrop entry for the hold at WIGAN is being depicted. Upon reaching the holding fix inbound, the entry arrows will be removed from the map and the dotted holding pattern will become active with magenta arrows.



Figure 9-53 Holding Pattern Entry

The active flight plan leg is WARIC to WHATE as indicated by the magenta line to the magenta labeled waypoint.

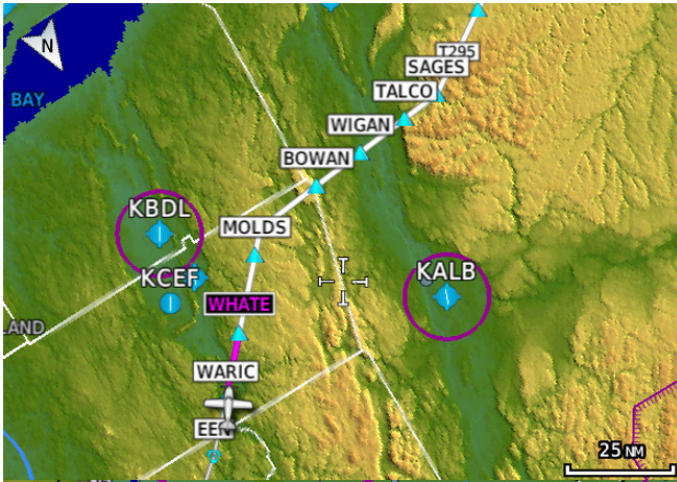

Figure 9-54 Active and Future Flight Plan Segments

The active leg is the course to OCITY intersection. After OCITY the flight plan depicts a turn to 100° for vectors.



Figure 9-55 Active Leg to Vectors

Foreword

Getting Started

Audio & Xpdr Ctrl

Com/Nav

FPL

Direct-To

Proc

Charts

Wpt Info

Map

Traffic

Terrain

Weather

Nearest

Services/ Music

Utilities

System

Messages

Symbols

Appendix

Previous legs are light gray, active leg is magenta.

- Foreword
- Getting Started
- Audio & Xpdr Ctrl
- Com/Nav
- FPL
- Direct-To
- Proc
- Charts
- Wpt Info
- Map
- Traffic
- Terrain
- Weather
- Nearest
- Services/Music
- Utilities
- System
- Messages
- Symbols
- Appendix



Figure 9-56 Exiting the Hold

The leg outbound from LSO is active and indicates a procedure turn. When inbound from the procedure turn the inbound segment will become active and LSO will still be the active waypoint.



Figure 9-57 Active Procedure Turn

A flight plan along T295 with previous, the active leg and the future legs depicted.



Figure 9-58 Past, Active and Future Flight Plan Segments

Active Heading Leg



Figure 9-59 Active Heading Leg (Vectors)

Foreword

Getting Started

Audio & Xpdr Ctrl

Com/Nav

FPL

Direct-To

Proc

Charts

Wpt Info

Map

Traffic

Terrain

Weather

Nearest

Services/ Music

Utilities

System

Messages

Symbols

Appendix

Active Flight Plan Leg

- Foreword
- Getting Started
- Audio & Xpdr Ctrl
- Com/Nav
- FPL
- Direct-To
- Proc
- Charts
- Wpt Info
- Map
- Traffic
- Terrain
- Weather
- Nearest
- Services/Music
- Utilities
- System
- Messages
- Symbols
- Appendix



Figure 9-60 Active Flight Plan Leg

The active flight plan leg inbound to a holding pattern at WIGAN intersection.



Figure 9-61 Active Flight Plan Leg Prior to Holding Pattern

10 TRAFFIC

The Traffic function displays available traffic information depending on your installed equipment to assist in situational awareness. The features and operation depend on the capabilities and options of each type of traffic system.



NOTE: The reference point for the ownship is the nose of the ownship aircraft symbol (either miniature aircraft or triangle). The reference point for all traffic icons is the center of the depicted traffic.



1. From the Home page, touch the **Traffic** key.
2. Use the active areas on the display and the Menu options to set up the Traffic display.

10.1 Traffic Pop-Up

When the GTN 7XX is displaying any page (other than the Traffic page) and a traffic alert becomes active, the Traffic Warning pop-up will be displayed.



NOTE: The traffic pop-up will not appear when your aircraft is on the ground.

1. The traffic pop-up will appear on pages other than the Traffic page when a traffic alert occurs.

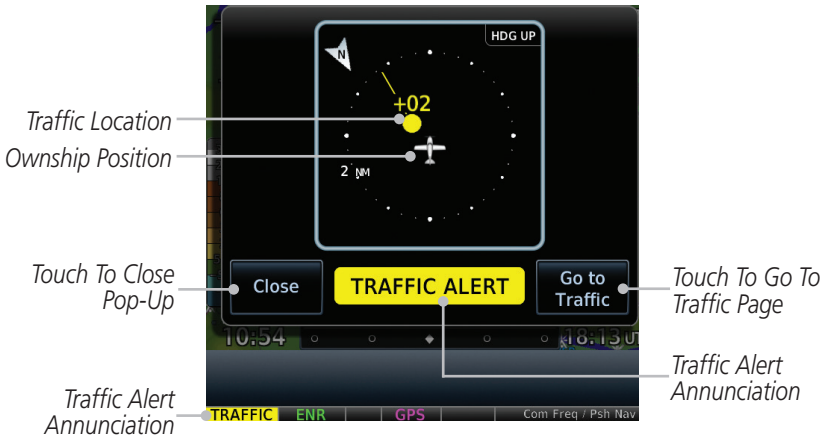

Figure 10-1 Traffic Pop-Up On the Map Page



2. Touch the **Go to Traffic** key to view the Traffic page.

OR



3. Touch the **Close** key to close the pop-up. The pop-up will return if the traffic alert persists.

10.2 Traffic Test

The Traffic Test function is only available on some traffic systems. The aircraft must be on the ground and Traffic Status must be in Standby.

1. Touch the **Test** key to activate the test function in the Traffic equipment.

Traffic Status
Standby



Test Traffic Status

Touch For Traffic Test
While In Standby
Traffic Status

Figure 10-2 Traffic Test Mode

2. The unit will return to normal operation mode after the test process is successfully completed.

10.3 TIS (Optional)



WARNING: The Traffic Information Service (TIS) is intended for advisory use only. TIS is intended to help the pilot locate traffic visually. It is the responsibility of the pilot to see and maneuver to avoid traffic.



NOTE: TIS is available only when the aircraft is within the service volume of a TIS-capable terminal radar site. Aircraft without an operating transponder are invisible to both Traffic Advisory Systems (TAS) and TIS. Aircraft without altitude reporting capability are shown without altitude separation data or climb/descent indication.



NOTE: TIS and Traffic Advisory System (TAS) may not both be configured at the same time.



NOTE: GDL 88 equipped aircraft only: When the radio tower symbol is crossed out, the aircraft is not a participant in the TIS-B system – i. e., not visible to other TIS-B clients. The GDL 88 will, however, continue to receive available TIS-B and FIS-B ground station up-links and continue to display TIS-B and FIS-B data along with available ADS-B and ADS-R data.



NOTE: Except for GDL 88 or GTX 345 equipped aircraft, TIS, and Traffic Advisory System (TAS) may not both be displayed at the same time.



NOTE: For more information about the GDL 88, refer to the "GDL 88 ADS-B Transceiver Pilot's Guide." For information about the GTX 345, refer to the "GTX 335/345 Pilot's Guide."

Traffic Information Service (TIS) is designed to help in detection and avoidance of other aircraft. TIS uses the Mode S transponder for the traffic data link. TIS receives traffic information from ground stations, and is updated every five seconds. The GTN 7XX displays up to eight traffic targets within a 7.5 NM radius, from 3000 feet below to 3500 feet above the requesting aircraft.

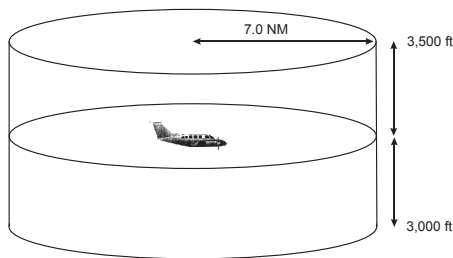

Figure 10-3 TIS Coverage Volume (not to scale)

10.3.1 TIS Symbology

Traffic is displayed according to TCAS symbology using three different symbols.



TIS Symbol	Description
	Non-Threat Traffic
	Traffic Advisory (TA)
	Traffic Advisory Off Scale

Table 10-1 TIS Traffic Symbols

Traffic Advisories (TA) alert the crew to intruding aircraft. When traffic meets the advisory criteria for the TA, a solid yellow circle symbol is generated. A Non-threat Advisory, shown as an open white diamond, indicates that an intruding aircraft is at greater than ± 1200 feet relative altitude or the distance is beyond five NM. A Traffic Advisory that is beyond the selected display range is indicated by a half TA symbol at the edge of the screen at the relative bearing of the intruder.

TIS also provides a vector line showing the direction in which the traffic is moving, to the nearest 45° . Traffic information for which TIS is unable to determine the bearing (non-bearing traffic) is displayed in the center of the Traffic Page or in a banner on maps other than the Traffic Map Page on which traffic can be displayed.

The altitude difference between the requesting aircraft and other intruder aircraft is displayed above/below the traffic symbol in hundreds of feet. If the other aircraft is above the requesting aircraft, the altitude separation appears above the traffic symbol with a "+" sign; if below, the altitude separation appears below. Altitude trend is displayed as an up/down arrow (for speeds greater than 500 fpm in either direction) to the right of the target symbol. Traffic symbols for aircraft without altitude reporting capability appear without altitude separation or climb/descent information.

Always remember that TIS cannot alert you to the presence of aircraft that are not equipped with transponders, nor can it alert you to aircraft that may be nearby, but obscured from the ground surveillance radar by interfering terrain.

10.3.2 Traffic Page

The Traffic Map Page is configured to show surrounding TIS traffic data in relation to the aircraft's current position and altitude, without clutter from the basemap. Aircraft orientation on this map is always heading up unless there is no valid heading.

The traffic mode is annunciated in the upper left corner of the Traffic Map Page. When the aircraft is on the ground, TIS automatically enters Standby Mode. Once the aircraft is airborne, TIS switches from Standby to Operating Mode and the GTN 7XX begins to display traffic information.

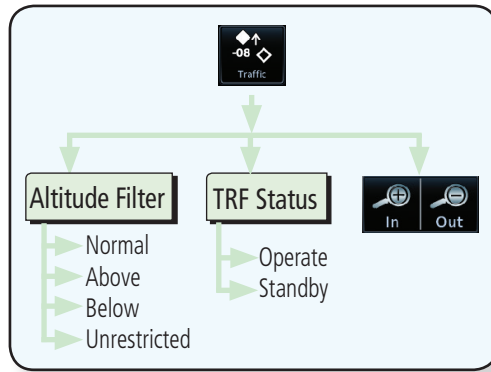

Figure 10-4 Traffic Page Functional Diagram

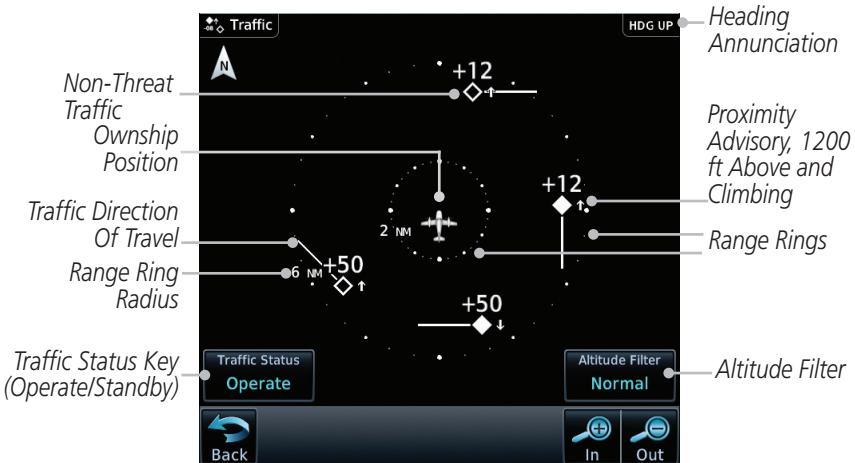

Figure 10-5 Traffic Page

10.3.3 Displaying Traffic on the Traffic Page

1. From the Home page, touch the **Traffic** key.
2. Confirm TIS is in Operating Mode.
3. Touch the **Traffic Status** key to toggle between Operate and Standby mode.

10.3.4 Altitude Display

1. While viewing the Traffic page, touch the **Operate** key to begin displaying traffic. "Operate" is displayed in the Traffic Status field.
2. The Altitude Filter limits the traffic displayed to the Below, Normal, Above or Unrestricted altitude block as listed in the "Displayed Traffic Range" table. The filter altitudes are relative to ownship altitude. Touch the **Altitude Filter** key to change the altitude filter value. Select the desired altitude filter by touching the **BELOW, NORMAL, ABOVE, or UNRESTRICTED** keys. The selection is displayed in the Altitude mode field.

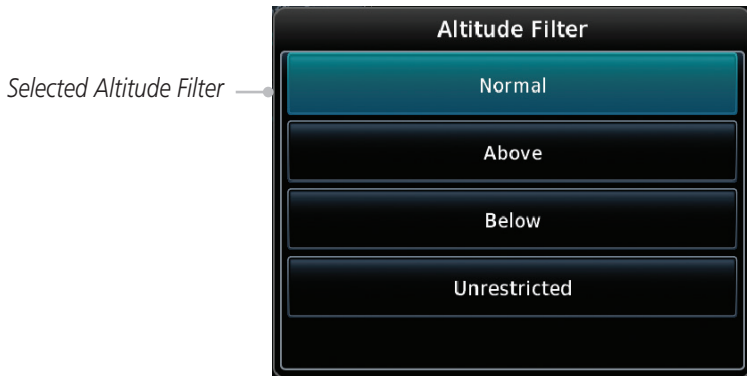

Figure 10-6 Traffic Altitude Filter Page

Altitude Mode	Displayed Traffic Range
Below	-9,900 ft to 2,700 ft
Normal	-2,700 ft to 2,700 ft
Above	-2,700 ft to 9,900 ft
Unrestricted	All Traffic Shown

Table 10-2 Displayed Traffic Range

10.3.5 TIS Limitations



NOTE: *This section on TIS Limitations is not comprehensive. Garmin recommends the user review the TIS Limitations section of the Aeronautical Information Manual, Section 1-3-5.*

TIS is NOT intended to be used as a collision avoidance system and does not relieve the pilot of responsibility to “see and avoid” other aircraft. TIS should not be used for avoidance maneuvers during IMC or other times when there is no visual contact with the intruder aircraft. TIS is intended only to assist in visual acquisition of other aircraft in VMC. No recommended avoidance maneuvers are provided for, nor authorized, as a direct result of a TIS intruder display or TIS advisory.

While TIS is a useful aid to visual traffic avoidance, it has some system limitations that must be fully understood to ensure proper use. Many of these limitations are inherent in secondary radar surveillance. In other words, the information provided by TIS will be no better than that provided to ATC. TIS will only display aircraft with operating transponders installed.

TIS relies on surveillance of the Mode S radar, which is a “secondary surveillance” radar similar to the Air Traffic Control Radar Beacon System (ATCRBS). TIS operation may be intermittent during turns or other maneuvering. TIS is dependent on two-way, “line-of-sight” communication between the aircraft and the Mode S radar. Whenever the structure of the client aircraft comes between the transponder antenna (usually located on the underside of the aircraft) and the ground-based radar antenna, the signal may be temporarily interrupted. Other limitations and anomalies associated with TIS are described in the AIM, Section 4-5-6.

- Foreword
- Getting Started
- Audio & Xpdr Ctrl
- Com/Nav
- FPL
- Direct-To
- Proc
- Charts
- Wpt Info
- Map
- Traffic**
- Terrain
- Weather
- Nearest
- Services/ Music
- Utilities
- System
- Messages
- Symbols
- Appendix



Garmin is not responsible for Mode S geographical coverage. Operation of the ground stations is the responsibility of the FAA. Refer to the Aeronautical Information Manual for a Terminal Mode S Radar Site Map covering the U.S.



NOTE: TIS will be unavailable at low altitudes in many areas of the U.S., particularly in mountainous regions. Also, when flying near the “floor” of radar coverage in a particular area, intruders below the client aircraft may not be detected by TIS.

TIS information is collected one radar scan prior to the scan during which the uplink occurs. Therefore, the surveillance information is approximately five seconds old. In order to present the intruders in a “real time” position, the TIS ground station uses a “predictive algorithm” in its tracking software. This algorithm uses track history data to extrapolate intruders to their expected positions consistent with the time of display in the cockpit. Occasionally, aircraft maneuvering will cause this algorithm to induce errors in the display. These errors primarily affect relative bearing information and traffic target track vector (it will lag); intruder distance and altitude will remain relatively accurate and may be used to assist in “see and avoid.” Some of the more common examples of these errors follow:

- When client or intruder aircraft maneuvers excessively or abruptly, the tracking algorithm may report incorrect horizontal position until the maneuvering aircraft stabilizes.
- When a rapidly closing intruder is on a course that crosses the client aircraft course at a shallow angle (either overtaking or head on) and either aircraft abruptly changes course within 0.25 NM, TIS may display the intruder on the opposite side of the client than it actually is.

These are relatively rare occurrences and will be corrected in a few radar scans once the course has stabilized.

- Foreword
- Getting Started
- Audio & Xpdr Ctrl
- Com/Nav
- FPL
- Direct-To
- Proc
- Charts
- Wpt Info
- Map
- Traffic**
- Terrain
- Weather
- Nearest
- Services/ Music
- Utilities
- System
- Messages
- Symbols
- Appendix
- Index

10.3.6 TIS Alerts

When the number of Traffic Advisories (TAs) on the Traffic Map Page increases from one scan to the next, the following occur:

- A single “Traffic” voice alert is generated.
- A TRAFFIC Annunciation appears at the bottom of the display, flashing for 5 seconds and remaining displayed until no TAs are detected in the area.

To reduce the number of nuisance alerts due to proximate aircraft, the “Traffic” voice alert is generated only when the number of TAs increases. For example, when the first TA is displayed, a voice and visual annunciation are generated. As long as a single TA remains on the display, no additional voice alerts are generated. If a second TA appears on the display or if the number of TAs initially decreases and then subsequently increases, another voice alert is generated.

A “Traffic Not Available” (TNA) voice alert is generated when the TIS service becomes unavailable or is out of range.

Traffic may not be displayed in the radar coverage area due to the following:

- Radar site TIS Mode S sensor is not operational or is out of service.
- Traffic or requesting aircraft is beyond the maximum range of the TIS-capable Mode S radar site.
- Traffic or requesting aircraft is above the radar site in the cone of silence and out of range of an adjacent site.
- Traffic or requesting aircraft is below radar coverage. In flat terrain, the coverage extends from about 3000 feet upward at 55 miles. Terrain and obstacles around the radar site can further decrease radar coverage in all directions.
- Traffic does not have an operating transponder.



10.3.7 TIS System Status

The GTN 7XX performs an automatic test of TIS during power-up. If TIS passes the test, TIS enters Standby Mode on the ground or Operating Mode in the air. If TIS fails the power up test, an annunciation is shown in the center of the Traffic Map Page. Contact a service center or Garmin dealer for corrective action for a failure message.

Traffic Page Annunciation	Description
No Data	Data is not being received from the transponder
Failed	The transponder has failed
Unavailable	TIS is unavailable or out of range

Table 10-3 TIS Failure Annunciations

The Traffic mode is annunciated in the bottom left corner of the Traffic Page. When the aircraft is on the ground, TIS automatically enters Standby Mode. Once the aircraft is airborne, TIS switches to Operating Mode and traffic information is displayed. The mode can be changed manually using the **Traffic Status** key.

Traffic Status	Traffic Mode Annunciation (Traffic On Map Page)	Traffic Display Enabled Icon (Other Maps)
TIS Operating	Operate	
TIS Standby	Standby	
TIS Failed*	TIS Fail	

* Contact a service center or Garmin dealer for corrective action

Table 10-4 TIS Modes Shown on the Map Page

The annunciations that indicate the status of traffic information appear in a banner at the bottom center of maps on which traffic can be displayed.

Traffic Status Banner Annunciation	Description
Traffic Coast 9 SEC	<p>The displayed data is not current (6 to 12 seconds since last message).</p> <p>The quality of displayed traffic information is reduced when this message is displayed.</p>
Traffic Removed	<p>Traffic is removed because it is too old for coasting (12 to 60 seconds since last message).</p> <p>Traffic may exist within the selected display range, but it is not displayed.</p>

Table 10-5 TIS Traffic Status Annunciations

- Foreword
- Getting Started
- Audio & Xpdr Ctrl
- Com/Nav
- FPL
- Direct-To
- Proc
- Charts
- Wpt Info
- Map
- Traffic**
- Terrain
- Weather
- Nearest
- Services/ Music
- Utilities
- System
- Messages
- Symbols
- Appendix

10.4 TAS (Optional)



NOTE: *TIS and Traffic Advisory System (TAS) may not both be configured at the same time.*

TAS data comes from a TAS unit such as a Garmin GTS 800 or 820, Skywatch 497, KTA 810, or other unit.

Refer to the appropriate Traffic Advisory System's Pilot's Guides for a detailed discussion of the respective traffic advisory system.

The type of traffic systems that is installed is described by the Traffic Page keys. If a Traffic Advisory System (TAS) is configured, a **Traffic Mode** and **Altitude Filter** key will be displayed.



NOTE: *Pilots should be aware of TAS system limitations. TAS systems require transponders of other aircraft to respond to system interrogations. If the transponders do not respond to interrogations due to phenomena such as antenna shading or marginal transponder performance, traffic may be displayed intermittently, or not at all. Aircraft without altitude reporting capability are shown without altitude separation data or climb descent indication. Pilots should remain vigilant for traffic at all times.*



WARNING: *The Traffic Advisory System (TAS) is intended for advisory use only to aid the pilot in visually acquiring traffic. No avoidance maneuvers should be based solely upon TAS traffic information. It is the responsibility of the pilot in command to see and maneuver to avoid traffic.*

A Traffic Advisory System (TAS) enhances flight crew situational awareness by displaying traffic information for transponder-equipped aircraft. The TAS also provides visual and aural traffic alerts including voice announcements to assist in visually acquiring traffic.

When the TAS is in Operating Mode, the unit interrogates the transponders of intruding aircraft while monitoring transponder replies. The TAS uses this information to derive the distance, relative bearing, and if reported, the altitude and vertical trend for each aircraft within its surveillance range. The TAS then calculates a closure rate to each intruder based on the projected Closest Point of Approach (CPA). If the closure rate meets the threat criteria for a Traffic Advisory (TA), visual and aural alerting is provided.

10.4.1 TAS Symbology

Traffic Advisory System (TAS) is designed to help in detection and avoidance of other aircraft. TAS uses an on-board interrogator-processor to detect traffic. Only aircraft with operating transponders will be detected. Traffic is displayed according to TCAS symbology using four different symbols.





TAS Symbol	Description
	Non-Threat Traffic (intruder is beyond 5 NM and greater than 1,200 ft vertical separation)
	Proximity Advisory (PA) (intruder is within 5 NM and less than 1,200 ft vertical separation)
	Traffic Advisory (TA) (closing rate, distance, and vertical separation meet TA criteria)
	Traffic Advisory Off Scale

Table 10-6 TAS Intruder Symbol Description



Figure 10-7 Intruder Type, Altitude, and Vertical Trend

10.4.2 Displaying and Operating Traffic (TAS Systems)

The unit must be in Operating mode for traffic to be displayed. The ability to switch from Standby to Operating mode on the ground is especially useful for scanning the airspace around the airport before takeoff.

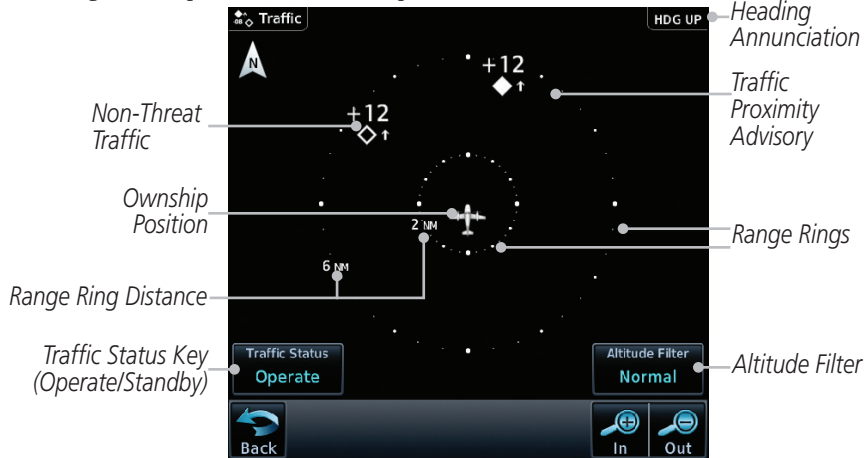

Figure 10-8 Traffic Page

10.4.2.1 Switching from Standby Mode to Operating Mode

1. From the Home page, touch the **Traffic** key.
2. Confirm TAS is in Operating Mode.
3. Touch the **Traffic Status** key to toggle between Operate and Standby mode.
4. The **Altitude Filter** limits the traffic displayed to the Below, Normal, Above or Unrestricted altitude block as listed in the "Displayed Traffic Range" table. The filter altitudes are relative to ownship altitude. Touch the **Altitude Filter** key to change the altitude filter value.

NOTE: Not all TAS systems can be set to "Standby" mode while in the air.

The Traffic Page shows surrounding TAS traffic data in relation to the aircraft's current position and altitude without basemap clutter. Aircraft orientation is always heading up unless no valid heading is received. The Traffic Status is announced in the lower left corner and the Altitude Filter is announced in the lower right corner.



10.4.2.2 Range Ring

Touching the **In** and **Out** keys will zoom in and out in preset steps depending on the installed equipment as shown in the following table.

Traffic Device	Map Ranges
Garmin GTS 800, Skywatch (SKY497/SKY889)	2 NM, 6 NM, 12 NM
Garmin GTS 820 and 850, Honeywell KTA 810 TAS, KTA 910 TAS, KMH 820 IHAS, KMH 920 IHAS, and Avidyne TAS 620 (Ryan 9900BX)	2 NM, 6 NM, 12 NM, 24 NM, 40 NM

Table 10-7 Available Traffic Range Ring Steps

10.4.3 Altitude Display

Traffic Status
Operate

1. While viewing the Traffic page, touch the **Traffic Status** key to begin displaying traffic. "TAS OPERATING" is displayed in the Traffic mode field.

Altitude Filter
Normal

2. Touch the **Altitude Filter** key to change the altitude filter value. The filter altitudes are relative to ownship altitude. Select the desired altitude filter by touching the **BELOW, NORMAL, ABOVE,** or **UNRESTRICTED** keys. The selection is displayed in the Altitude mode field.

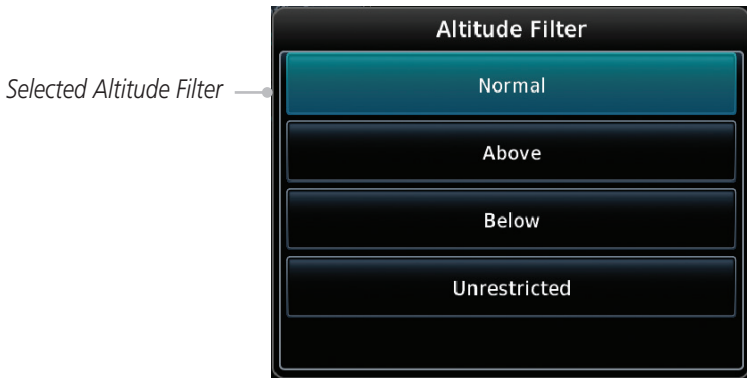

Figure 10-9 Traffic Altitude Filter Page

Altitude Mode	Displayed Traffic Range
Below	-9,900 ft to 2,700 ft
Normal	-2,700 ft to 2,700 ft
Above	-2,700 ft to 9,900 ft
Unrestricted	All Traffic Shown

Table 10-8 Displayed Traffic Range

10.4.4 Traffic System Status



NOTE: Refer to the equipment documentation for information on the self-test and operating modes.

The Traffic Status is indicated in the lower left corner of the Traffic Page.





Mode	Traffic Mode Annunciation (Traffic Page)	Traffic Display Enabled Icon (Other Maps)
TAS Self-test Initiated	Test	
TAS Operating	Operate	
TAS Standby	Standby	
TAS Failed	TAS Fail	

Table 10-9 TAS Modes

If the unit fails, an annunciation as to the cause of the failure is shown in the center of the Traffic Page.

Traffic Page Annunciation	Description
No Data	Data is not being received from the TAS unit
Data Failed	Data is being received from the TAS unit, but the unit is self-reporting a failure
Failed	Incorrect data format received from the TAS unit

Table 10-10 TAS Failure Annunciations

10.5 ADS-B Traffic

ADS-B technology is an important part of the FAA's Next Generation Air Transportation System (NextGen), allowing for enhanced safety, efficiency, and the ability of the system to handle greater numbers of aircraft. ADS-B In allows a properly-equipped aircraft to access FAA broadcast services such as TIS-B and FIS-B. With ADS-B Out, the avionics transmit an aircraft's precise location, as well as specific information about that aircraft, to ground stations and other aircraft.

If more than one target is occupying the same area of the screen, the GTN will combine the two traffic targets into one traffic group. The group symbol maintains the iconology of the highest priority traffic target in the group and indicates a grouped symbol by the presence of an asterisk to the left of the grouped traffic target.

Traffic targets displayed on the dedicated traffic page may be selected in order to obtain additional information about a traffic target or to view all targets in a grouped target. When a grouped target is selected, the **Next** key on the dedicated traffic page will cycle through all targets located in close proximity to where the screen has been touched.

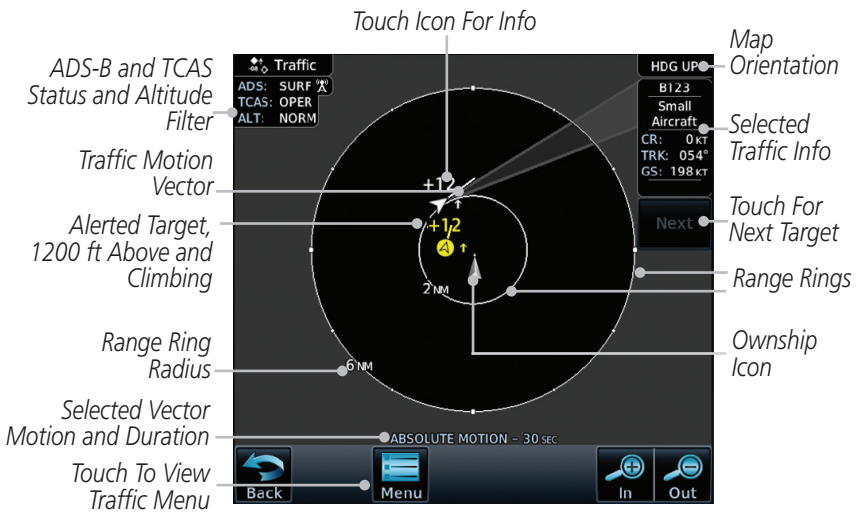

Figure 10-10 ADS-B Traffic Page



NOTE: The "Next" key on the dedicated traffic page will cycle through all targets located in close proximity to where the pilot has touched the screen.

- Foreword
- Getting Started
- Audio & Xpdr Ctrl
- Com/Nav
- FPL
- Direct-To
- Proc
- Charts
- Wpt Info
- Map
- Traffic
- Terrain
- Weather
- Nearest
- Services/Music
- Utilities
- System
- Messages
- Symbols
- Appendix

Foreword
Getting Started
Audio & Xpdr Ctrl
Com/Nav
FPL
Direct-To
Proc
Charts
Wpt Info
Map
Traffic
Terrain
Weather
Nearest
Services/
Music
Utilities
System
Messages
Symbols
Appendix













Symbol	Description
	Basic Non-Directional Traffic
	Basic Directional Traffic
	Basic Off-scale Selected Traffic
	Proximate Non-Directional Traffic
	Proximate Directional Traffic
	Proximate Off-scale Selected Traffic
	Non-Directional Alerted Traffic
	Off-Scale Non-Directional Alerted Traffic
	Directional Alerted Traffic
	Off-Scale Directional Alerted Traffic
	Non-Directional Surface Vehicle
	Directional Surface Vehicle

Table 10-11 ADS-B Traffic Symbols



NOTE: Color of basic and proximate traffic is dependent on configuration (cyan or white) and airborne/on-ground status of target (target is brown when on the ground, see the surface vehicles).

10.5.1 Traffic Applications - SURF, AIRB, etc.

The GTN ADS-B traffic display is capable of running in two “modes:” Airborne Situational Awareness (AIRB) and Surface Situation Awareness (SURF).

AIRB is in operation in the en route environment, outside of five NM from and 1,500 feet above the nearest airport.

SURF is in operation within the terminal environment (within five NM and less than 1,500 feet above field elevation). When SURF is running, and the zoom scale on the traffic display is less than two NM, the airport environment (including taxiways and runways) is displayed in addition to traffic. This is to aid in situational awareness of runway occupancy/availability, etc.

Due to the varying precision of the data received via ADS-B, ADS-R, and TIS-B, all traffic targets may not be depicted on the traffic display. Because higher data precision is required for display in the SURF environment, some targets eligible for AIRB will not be displayed while SURF is active. Individual eligibility for AIRB and SURF is depicted in the selected traffic data on the traffic page.

10.5.2 ADS-B Traffic Menu

The Traffic Menu allows control of the traffic information display.

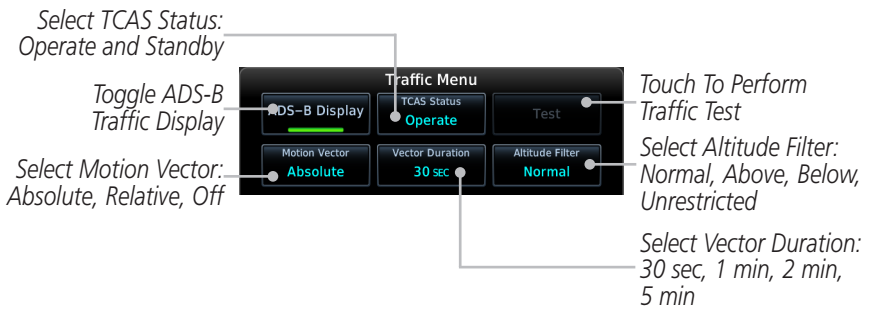
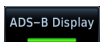

Figure 10-11 ADS-B Traffic Menu

10.5.2.1 ADS-B Display



Touching **ADS-B Display** toggles the display of ADS-B traffic and ADS-B traffic alerting.

10.5.2.2 TCAS Status

This shows the current status of the TCAS system. The modes reported by the traffic device are "Operate" while in the air and "Standby" while on the ground. This control allows the pilot to manually select the TCAS Status.



Touch the **TCAS Status** key to toggle the TCAS Status.

10.5.2.3 Test

The Traffic Test function is only available on some TAS traffic systems. The aircraft must be on the ground and traffic system must be in Standby.



1. Touch the **Test** key to activate the test function in the Traffic equipment.
2. The unit will return to normal operation mode after the test process is successfully completed.

10.5.2.4 Motion Vector

When Absolute Motion Vectors are selected, the vectors extending from the traffic targets depict the target reported track and speed over the ground. When Relative Motion Vectors are selected, the vectors extending from the traffic targets display how the traffic target is moving relative to your aircraft. These vectors are calculated using the traffic targets track and ground speed and your aircraft's track and ground speed. These two values are combined to depict where the traffic target is moving purely with respect to your aircraft and give a forecast of where the traffic target will be, relative to your aircraft, in the near future.

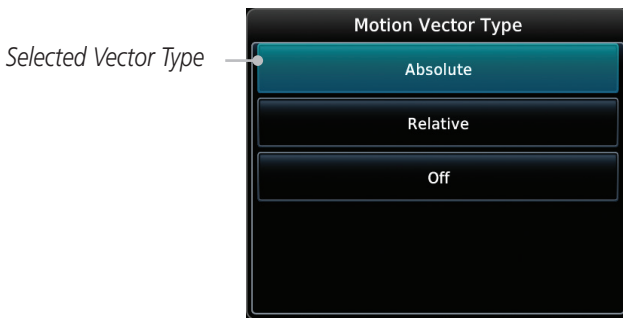

Figure 10-12 Traffic Motion Vector Type Selection



NOTE: Absolute motion vectors are colored either white or cyan. Relative motion vectors are always green. The annunciation on the bottom of the dedicated traffic page indicates which vector type is selected and their length.

* Indicates Multiple Targets. Touch NEXT To View Each Target.

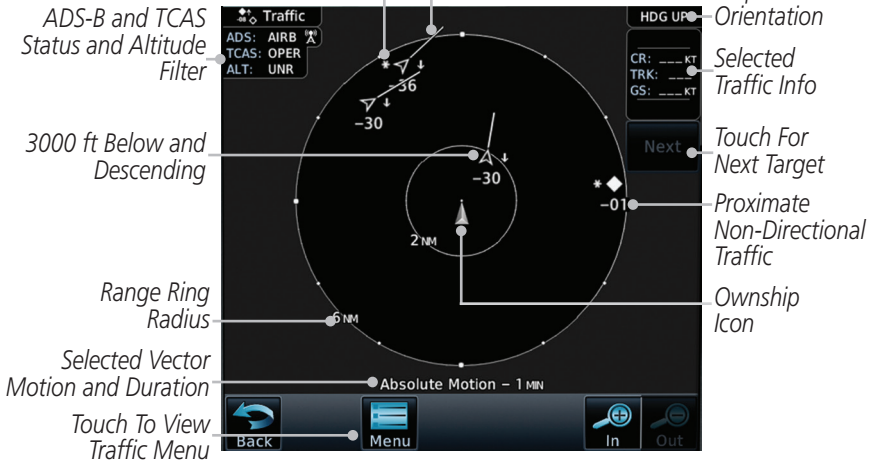

Figure 10-13 Absolute Motion (White Vectors)

* Indicates Multiple Targets. Touch NEXT To View Each Target.

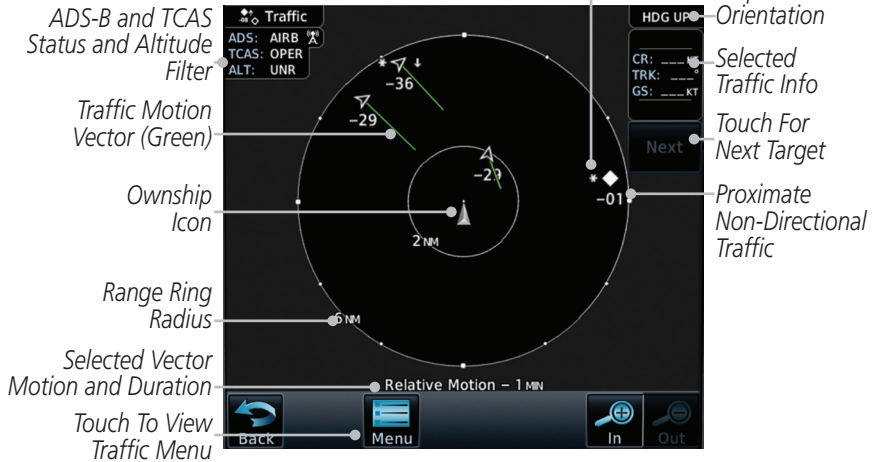

Figure 10-14 Relative Motion (Green Vectors)

Foreword
Getting Started
Audio & Xpdr Ctrl
Com/Nav
FPL
Direct-To
Proc
Charts
Wpt Info
Map
Traffic
Terrain
Weather
Nearest
Services/Music
Utilities
System
Messages
Symbols
Appendix

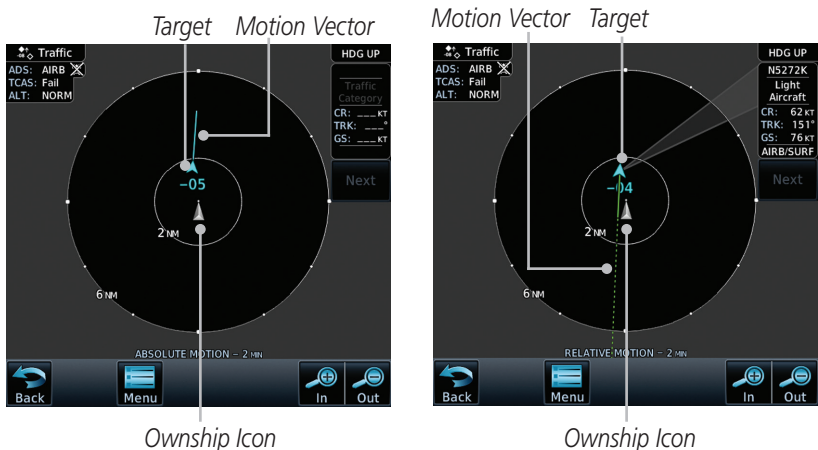

Figure 10-15 Comparison of Absolute and Relative Motion Vectors With a Single Target

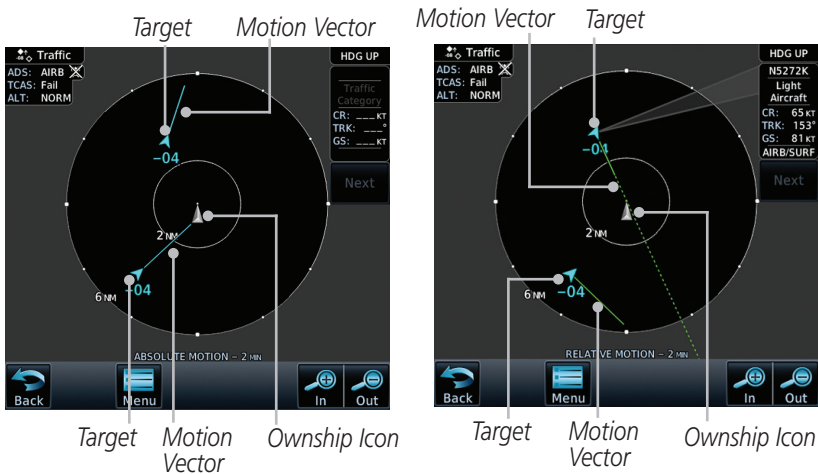

Figure 10-16 Comparison of Absolute and Relative Motion Vectors With a Two Targets

10.5.2.5 Vector Duration

The Vector Duration selection sets the time that the vector will show the calculated distance and direction of the traffic target. A longer duration will result in a longer vector.

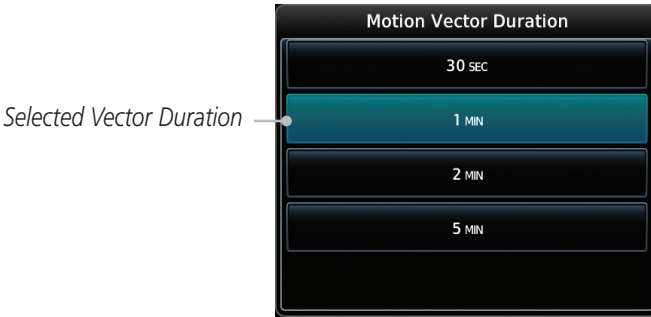

Figure 10-17 Traffic Motion Vector Duration Selection

10.5.2.6 Altitude Filter



1. The Altitude Filter limits the traffic displayed to the Below, Normal, Above or Unrestricted altitude block as listed in the "Displayed Traffic Range" table. The filter altitudes are relative to ownship altitude. Touch the **Altitude Filter** key to change the altitude filter value.
2. Select the desired altitude filter by touching the **BELOW**, **NORMAL**, **ABOVE**, or **UNRESTRICTED** keys. The selection is displayed in the Altitude mode field.

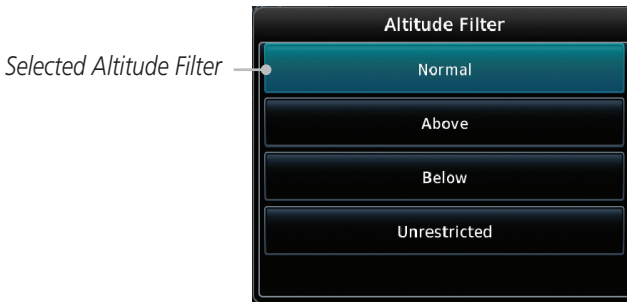

Figure 10-18 Traffic Altitude Filter Selection

Altitude Mode	Displayed Traffic Range
Below	-9,900 ft to 2,700 ft
Normal	-2,700 ft to 2,700 ft
Above	-2,700 ft to 9,900 ft
Unrestricted	All Traffic Shown

Table 10-12 Displayed Traffic Range

10.5.2.7 On Scene Mode

When a GDL 88 (with software v3.00, or later) or GTX 345 is installed with a GTN in a helicopter, the GTN provides controls for enabling/disabling “On Scene” mode. “On Scene” mode decreases traffic alerts when operating near other helicopters (e.g., news reporting).



1. While viewing the Traffic page, touch the **Menu** key.

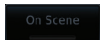

2. Touch the **On Scene** key to enable/disable On Scene mode.

10.5.3 Rotorcraft Traffic Page Orientation



NOTE: Rotorcraft Traffic Page Orientation functionality is available in software v5.12 or later.

When flying at low speeds in a helicopter, heading may not always be closely aligned with track (it could easily be up to 180 degrees different). If the GTN is interfaced with a heading source, the ADS-B traffic page will remain fixed with the ownship heading pointed up. However, if heading is not being received by the GTN, the display of ADS-B traffic will be unavailable.

When one of the following conditions is true, the ADS-B traffic page will be unavailable, and a "Display Unavailable" banner will be displayed.

- Ownship directionality is invalid (no valid heading or track)
- GPS ground speed is less than 15 knots and ownship heading is not available

While the traffic display is unavailable due to these conditions, traffic alerts will be provided in a non-bearing textual form at the top of the traffic page.

10.6 RYAN TCAD 9900BX with the GDL 88



NOTE: When a TCAD is connected to a GTX 345, the available controls will appear as described for a TCAS in section 10.5.2.

Ryan TCAD is a system that provides audio and visual alerts for traffic near your aircraft. The information from this system can be interfaced through the GTN series. Operating instructions and details on the modes of operation are described in the Ryan TCAD operator's handbooks.

- TCAS-like symbols are used in the 9900BX.
- Altitude modes are available (normal, look up, look down, unrestricted).
- Ranges are manually controlled for the current shield.
- Traffic display range selections:
 - Ryan 9900BX — 1 NM, 2 NM, 2 and 6 NM, 6 and 12 NM, and 12 and 24 NM.

10.6.1 Ryan TCAD Description



NOTE: Refer to the *Ryan TCAD Pilot's Guide* for a detailed description of the Ryan TCAD System.

The Ryan TCAD (Traffic and Collision Alert Device) is an on-board air traffic display used to identify potential collision threats. TCAD computes relative altitude and range of threats from nearby Mode C and Mode S-equipped aircraft. TCAD will not detect aircraft without operating transponders or those that are beyond radar coverage. TCAD, within defined limits, creates a "shield" of airspace around the aircraft that detected traffic cannot penetrate without triggering an alert.

TA: Traffic Advisory. This is traffic with 500 feet, or less, of altitude separation that is converging or maintaining altitude separation.

PA: Proximity Advisory. This is traffic with 500 feet of altitude separation that is not a TA.

TRFC: Other traffic.

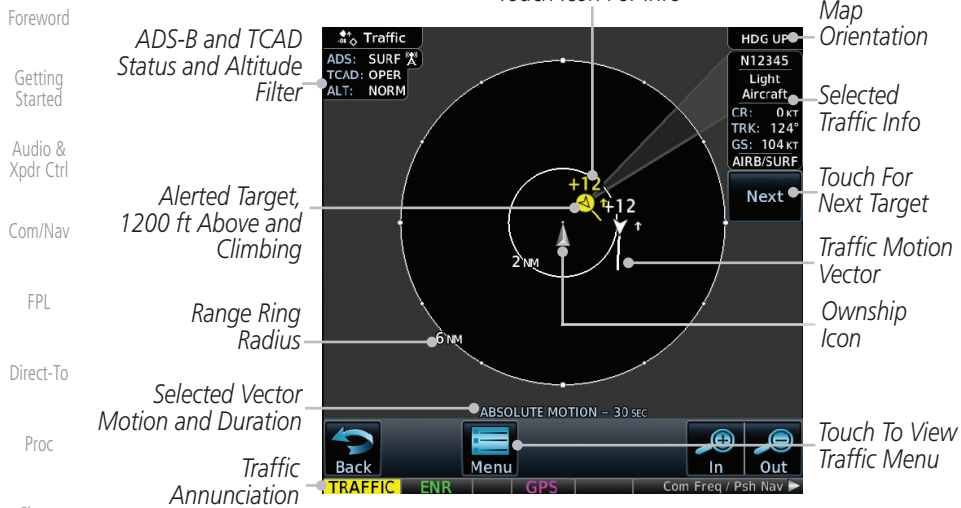

Figure 10-19 Traffic Page for Ryan TCAD with GDL 88

10.6.2 Altitude Mode

The GDL 88 has four altitude display modes: Normal ($\pm 2,700$ feet, Above (-2,700 feet to +9,900 feet), Below (-9,900 feet to +2,700 feet), and Unrestricted ($\pm 9,900$ feet). The GDL 88 continues to track up to 30 intruder aircraft within its maximum surveillance range, regardless of the altitude display mode selected.

The selected altitude display mode is displayed in the upper left-hand corner of the Traffic page.

The Altitude Filter limits the traffic displayed to the Below, Normal, Above or Unrestricted altitude block as listed in the "Displayed Traffic Range" table. The filter altitudes are relative to ownship altitude. While viewing the Traffic page, touch the **Altitude Filter** key to change the altitude filter value. Select the desired altitude filter by touching the **BELOW**, **NORMAL**, **ABOVE**, or **UNRESTRICTED** keys. The selection is displayed in the Altitude mode field.



Foreword
Getting Started
Audio & Xpdr Ctrl
Com/Nav
FPL
Direct-To
Proc
Charts
Wpt Info
Map
Traffic
Terrain
Weather
Nearest
Services/Music
Utilities
System
Messages
Symbols
Appendix

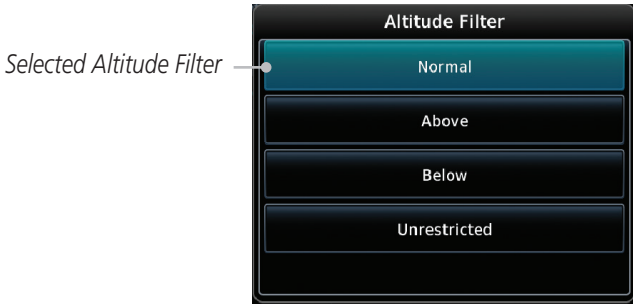

Figure 10-20 Traffic Altitude Filter Selection

Altitude Mode	Displayed Traffic Range
Below	-9,900 ft to 2,700 ft
Normal	-2,700 ft to 2,700 ft
Above	-2,700 ft to 9,900 ft
Unrestricted	All Traffic Shown

Table 10-13 Displayed Traffic Range

10.6.3 TCAD Control Menu

The TCAD Control Menu allows control over the settings for the TCAD Traffic display.

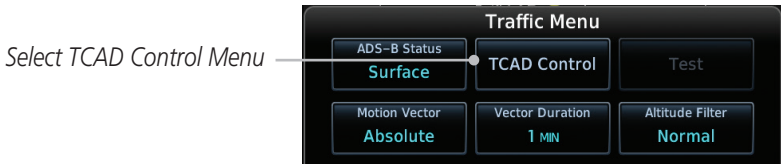

Figure 10-21 TCAD Traffic Menu

1. While viewing the Traffic menu, touch the **TCAD Control** key.

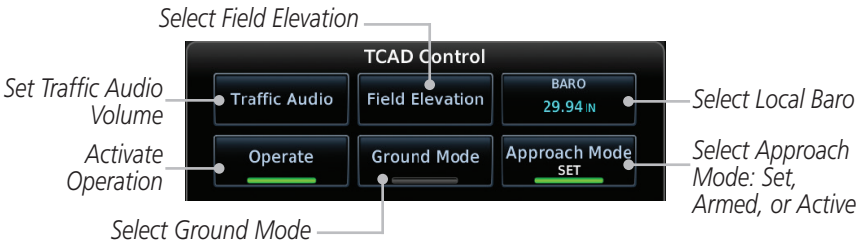

Figure 10-22 TCAD Control Menu

2. Touch the desired key from the menu to make any settings.

10.6.3.1 Traffic Audio



1. While viewing the TCAD Control menu, touch the **Traffic Audio** key.

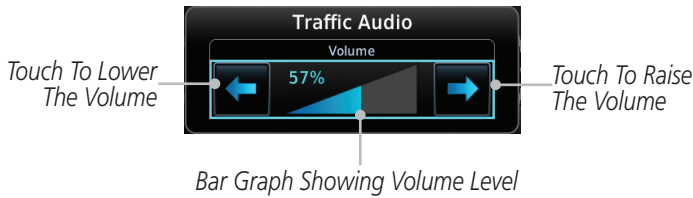

Figure 10-23 TCAD Traffic

2. Touch the arrow keys to raise or lower the TCAD Traffic Audio level. The selected volume will be shown as a percentage value and graphically with a bar graph.
3. Touch the **Back** key to return to the TCAD Control menu.



10.6.3.2 Field Elevation



1. While viewing the TCAD Control menu, touch the **Field Elevation** key.



Figure 10-24 TCAD Traffic Field Elevation Selection

2. With the **Use DEST APT** key deactivated (no green bar), touch the **Field Elevation** key to manually select the Field Elevation for traffic reporting. Use the keypad to select the elevation value.
3. Touch the **Enter** key to accept the selected value. The selected value will be shown in the **Field Elevation** key.
4. Touch the **Use DEST APT** key to automatically use the field elevation of the destination airport of the active flight plan for traffic reporting.



NOTE: Activating the **Use DEST APT** feature automatically uses the elevation for the current destination airport for the TCAD. If no destination airport is present in the GTN system, the TCAD will not receive a field elevation and therefore not automatically enter approach mode.

10.6.3.3 Baro



1. While viewing the TCAD Control menu, touch the **BARO** key to manually select the barometric pressure.
2. Use the keypad to select the barometric pressure value.
3. Touch the **Enter** key to accept the selected value. The selected value will be shown in the **BARO** key.



10.6.3.4 Operate

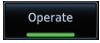

1. While viewing the TCAD Control menu, touch the **Operate** key to activate TCAD traffic.
2. Touching the **Operate** key toggles TCAD traffic operation on and off.

10.6.3.5 Ground Mode

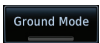

1. While viewing the TCAD Control menu, touch the **Ground** key to activate Ground Mode TCAD traffic.
2. Touching the **Ground** key toggles Ground Mode on and off.

10.6.3.6 Approach Mode

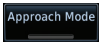

1. While viewing the TCAD Control menu, touch the **Approach** key to activate Approach Mode TCAD traffic.
2. Touching the **Approach** key toggles Approach Mode on and off.

Foreword

Getting Started

Audio & Xpdr Ctrl

Com/Nav

FPL

Direct-To

Proc

Charts

Wpt Info

Map

Traffic

Terrain

Weather

Nearest

Services/ Music

Utilities

System

Messages

Symbols

Appendix

10.7 TCAD 9900B Operation

The TCAD 9900B provides a passive system that uses transponder replies from other aircraft to acquire traffic information.

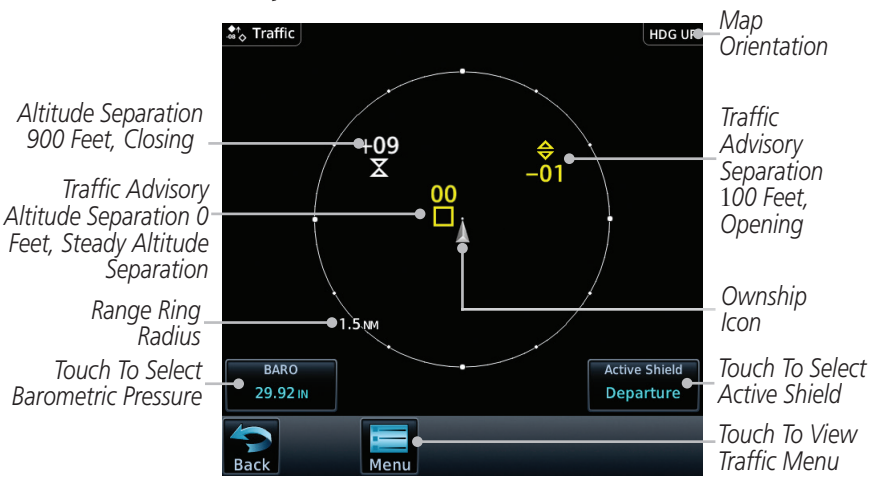

Figure 10-25 Traffic Page for Ryan TCAD 9900B

Symbol		Description
Imminent Traffic (Traffic within ± 500 feet AND 1.0 NM; OR no altitude AND within 1.0 NM)	Non-Imminent Traffic	
		Traffic Closing Vertically
		Traffic Diverging Vertically
		Traffic not Closing or Diverging Vertically

Table 10-14 9900B TCAD Symbols

10.7.1 Select Local Barometric Pressure



1. While viewing the TCAD display, touch the **Baro** key to select the local barometric pressure.



2. Use the keypad to select the values and touch **Enter** to save the values.

10.7.2 Select Active Shield



1. While viewing the TCAD display, touch the **Active Shield** key to select the Active Shield values (Departure, Enroute, or Ground).



2. Touch the desired setting to save the values.

10.7.3 TCAD 9900B Traffic Menu

The TCAD 9900B Menu allows control over the settings for the TCAD Traffic display.



1. While viewing the Traffic page, touch the **Menu** key.



Figure 10-26 TCAD 9900B Traffic Menu

2. Touch the desired key from the menu to make any settings.

10.7.3.1 Traffic Audio



1. While viewing the TCAD Control menu, touch the **Traffic Audio** key.

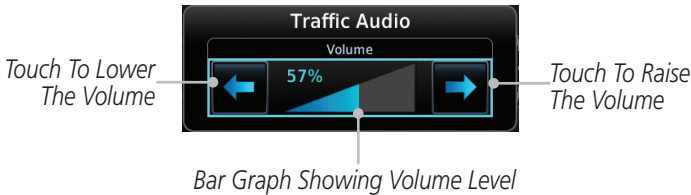

Figure 10-27 TCAD Traffic Audio



2. Touch the arrow keys to raise or lower the TCAD Traffic Audio level. The selected volume will be shown as a percentage value and graphically with a bar graph.



3. Touch the **Back** key to return to the TCAD Control menu.

10.7.3.2 Shield Setup

The Shield Setup function allows you to select the Shield Type (mode of operation) and the size of the shield volume that will provide alerts when entered by aircraft.

Approach Shield Type

1. While viewing the TCAD Control menu, touch the **Shield Type** key and touch the Approach Shield Type.



Figure 10-28 TCAD 9900B Shield Setup for Approach

2. Touch the **Field Elevation** key.
3. With the **Use DEST APT** key deactivated (no green bar), touch the **Field Elevation** key to manually select the Field Elevation for traffic reporting. Use the keypad to select the elevation value.
4. Touch the **Enter** key to accept the selected value. The selected value will be shown in the **Field Elevation** key.
5. Touch the **Use DEST APT** key to automatically use the field elevation of the destination airport of the active flight plan for traffic reporting.

NOTE: Activating the Use DEST APT feature automatically uses the elevation for the current destination airport for the TCAD. If no destination airport is present in the GTN system, the TCAD will not receive a field elevation and therefore not automatically enter approach mode.



En Route, Standard, or Terminal Shield Type

Shield Type
Approach

1. While viewing the TCAD Control menu, touch the **Shield Type** key and touch the desired Shield Type: Enroute, Standard, or Terminal.

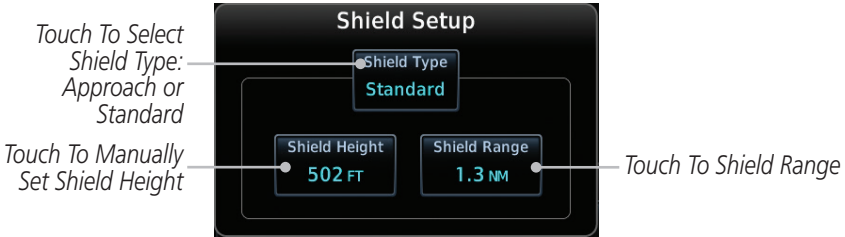

Figure 10-29 TCAD 9900B Shield Setup for En Route, Standard, and Terminal

Shield Height
500 FT

2. Touch the **Shield Height** key and use the keypad to select the Shield Height value. The selected value will be shown in the **Shield Range** key.

Shield Range
1.0 NM

3. Touch the **Shield Range** key and use the keypad to select the Shield Range value. The selected value will be shown in the **Shield Range** key.

10.7.3.3 Approach Mode

Approach Mode

1. While viewing the TCAD Control menu, touch the **Approach** key to activate Approach Mode TCAD traffic.
2. Touching the **Approach** key toggles Approach Mode between Set, Armed, or Active.

Foreword

Getting Started

Audio & Xpdr Ctrl

Com/Nav

FPL

Direct-To

Proc

Charts

Wpt Info

Map

Traffic

Terrain

Weather

Nearest

Services/ Music

Utilities

System

Messages

Symbols

Appendix

10.8 TCAD 9900BX Operation

The TCAD 9900BX provides an active system that interrogates other aircraft to acquire traffic information.

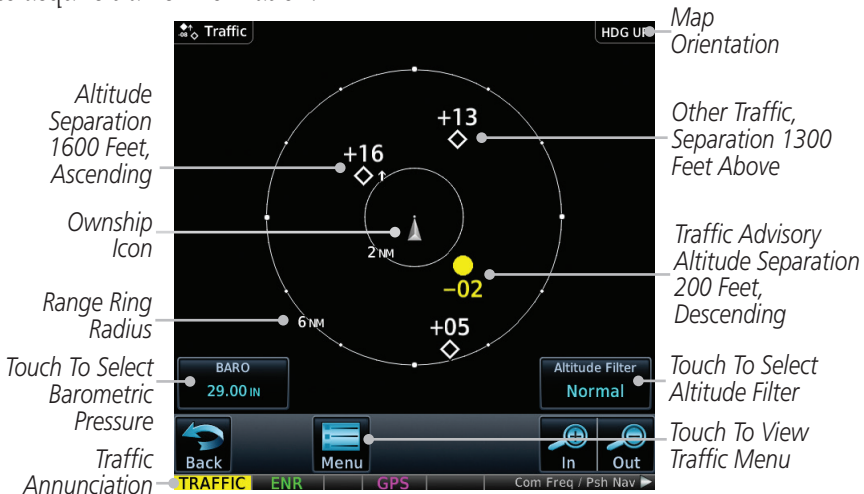

Figure 10-30 Traffic Page for Ryan TCAD 9900BX

Symbol	Description
	Traffic Advisory
	Proximity Advisory (color may be configured as cyan)
	Other Traffic (color may be configured as cyan)
	Out-of-Range Traffic Advisory

Table 10-15 9900BX (TCAS) Symbols

10.8.1 Select Local Barometric Pressure

1. While viewing the TCAD display, touch the **Baro** key to select the local barometric pressure.
2. Use the keypad to select the values and touch **Enter** to save the values.



10.8.2 Select Altitude Filter

Altitude Filter
Normal

The Altitude Filter limits the traffic displayed to the Below, Normal, Above or Unrestricted altitude block as listed in the “Displayed Traffic Range” table. The filter altitudes are relative to ownship altitude. While viewing the Traffic page, touch the **Altitude Filter** key to change the altitude filter value. Select the desired altitude filter by touching the **Normal**, **Above**, **Below**, or **Unrestricted** keys. The selection is displayed in the Altitude Filter field.

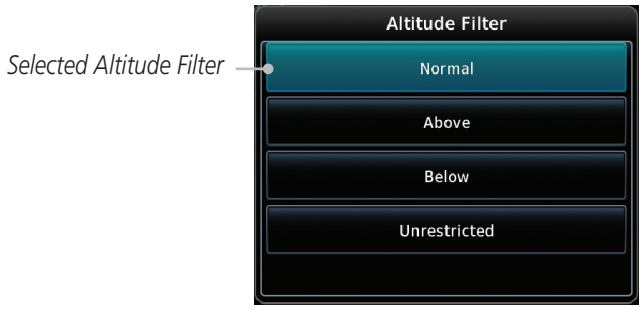

Figure 10-31 Traffic Altitude Filter Selection

Altitude Mode	Displayed Traffic Range
Below	-9,900 ft to 2,700 ft
Normal	-2,700 ft to 2,700 ft
Above	-2,700 ft to 9,900 ft
Unrestricted	All Traffic Shown

Table 10-16 Displayed Traffic Range

10.8.3 TCAD 9900BX Traffic Menu

The TCAD 9900BX Menu allows control over the settings for the TCAD Traffic display.

TCAD Control

1. While viewing the Traffic page, touch the **Menu** key.

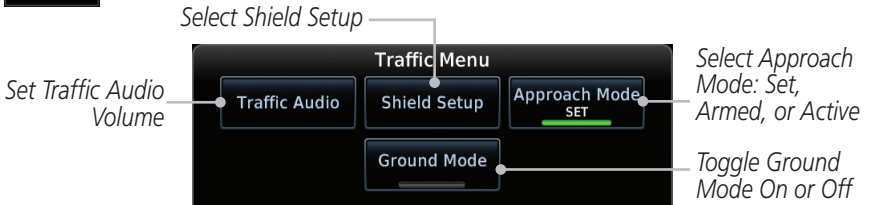

Figure 10-32 TCAD 9900BX Traffic Menu

2. Touch the desired key from the menu to make any settings.

10.8.3.1 Traffic Audio

Traffic Audio

1. While viewing the TCAD Control menu, touch the **Traffic Audio** key.

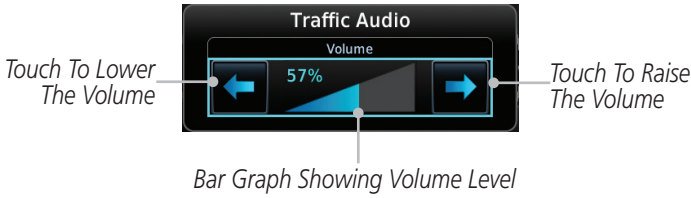

Figure 10-33 TCAD Traffic Audio

Left Arrow Right Arrow

2. Touch the arrow keys to raise or lower the TCAD Traffic Audio level. The selected volume will be shown as a percentage value and graphically with a bar graph.

Back

3. Touch the **Back** key to return to the TCAD Control menu.

10.8.3.2 Shield Setup

The Shield Setup function allows you to select the Shield Type (mode of operation) and the size of the shield volume that will provide alerts when entered by aircraft.

Approach Shield Type

Shield Type Approach

1. While viewing the TCAD Control menu, touch the **Shield Type** key and touch the Approach Shield Type.



Figure 10-34 TCAD 9900BX Shield Setup for Approach

Field Elevation

2. Touch the **Field Elevation** key.
3. With the **Use DEST APT** key deactivated (no green bar), touch the **Field Elevation** key to manually select the Field Elevation for traffic reporting. Use the keypad to select the elevation value.

Field Elevation 0 FT



4. Touch the **Enter** key to accept the selected value. The selected value will be shown in the **Field Elevation** key.



5. Touch the **Use DEST APT** key to automatically use the field elevation of the destination airport of the active flight plan for traffic reporting.



NOTE: *Activating the Use DEST APT feature automatically uses the elevation for the current destination airport for the TCAD. If no destination airport is present in the GTN system, the TCAD will not receive a field elevation and therefore not automatically enter approach mode.*

En Route, Standard, or Terminal Shield Type



1. While viewing the TCAD Control menu, touch the **Shield Type** key and touch the desired Shield Type: Enroute, Standard, or Terminal.

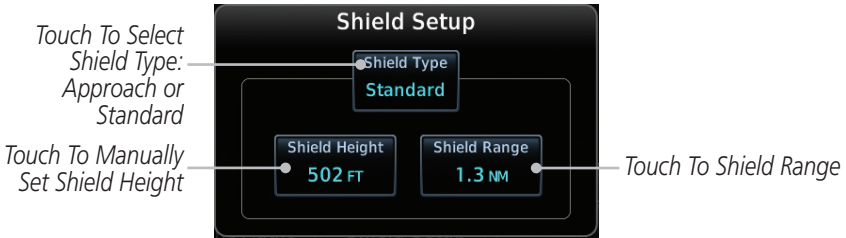

Figure 10-35 TCAD 9900BX Shield Setup for En Route, Standard, and Terminal



2. Touch the **Shield Height** key and use the keypad to select the Shield Height value. The selected value will be shown in the **Shield Range** key.



3. Touch the **Shield Range** key and use the keypad to select the Shield Range value. The selected value will be shown in the **Shield Range** key.

10.8.3.3 Approach Mode



1. While viewing the Traffic menu, touch the **Approach** key to activate Approach Mode TCAD traffic.

2. Touching the **Approach** key toggles Approach Mode between Set, Armed, or Active.

10.8.3.4 Ground Mode

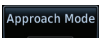

1. While viewing the Traffic menu, touch the **Ground** key to activate Ground Mode TCAD traffic.

2. Touching the **Ground** key toggles Ground Mode between On and Off.

10.9 TCAS II



NOTE: This feature is available with software v6.30 and later.



WARNING: Traffic information shown on system displays is provided as an aid in visually acquiring traffic. Traffic avoidance maneuvers are based upon TCAS II Resolution Advisories, ATC guidance, or positive visual acquisition of conflicting traffic.



WARNING: Do not rely solely upon the display of traffic information to accurately depict all of the traffic information within range of the aircraft. Due to lack of equipment, poor signal reception, and/or inaccurate information from other aircraft, traffic may be present but not represented on the displays.



NOTE: If the installed TCAS II traffic system is not a GTS 8000, refer to the applicable documentation for system-specific information.

A Traffic Alert and Collision Avoidance System II (TCAS II), such as the GTS 8000, improves flight safety by monitoring nearby airspace for aircraft flying with operating transponders. The TCAS II system provides traffic information to the displays. If separation from other aircraft is within certain limits, the system issues Traffic Advisories (TAs) assisting the flight crew in the visual acquisition of traffic, or Resolution Advisories (RAs) providing recommended vertical guidance maneuvers to resolve traffic conflicts.

10.9.1 TCAS II Theory of Operation

When the TCAS II system is operating in TA/RA or TA Only Mode, the system interrogates the transponders of other aircraft in the vicinity, and monitors for their replies. Based on successive replies, the system tracks the range, bearing, and (if reported) the altitudes of other aircraft. For each detected aircraft transponder, the system calculates time to, and separation at, the closest point of approach (CPA) around the potential collision area surrounding own aircraft. Based on CPA time, own aircraft altitude, and selected TCAS II system mode, the system determines if a TA or RA should be issued for a detected intruder.

- Foreword
- Getting Started
- Audio & Xpdr Ctrl
- Com/Nav
- FPL
- Direct-To
- Proc
- Charts
- Wpt Info
- Map
- Traffic**
- Terrain
- Weather
- Nearest
- Services/ Music
- Utilities
- System
- Messages
- Symbols
- Appendix
- Index

Altitude (Feet*)	TA Time to CPA (Seconds)	RA Time to CPA (Seconds)
0 - 1,000	20	RA not issued below 1,000 feet
1,000 - 2,350	25	15
2,350 - 5,000	30	20
5,000 - 10,000	40	25
10,000 - 20,000	45	30
20,000 and above	48	35

* System uses pressure altitude except when Radar Altitude is available. Radar Altitude takes precedence over pressure altitude reporting.

Table 10-17 Altitude-based TCAS II TA/RA Alert Thresholds

The TCAS II system categorizes detected traffic into four groups of increasing collision threat potential:

- **Other Traffic (OT)**, displayed as a hollow white diamond, is not currently a threat.
- **Proximate Traffic (PT)**, displayed as a filled white diamond, is not currently a threat, but is within 6 nm and $\pm 1,200$ feet of the own-aircraft altitude.
- **Traffic Advisory (TA)**, displayed as a filled yellow circle, indicates traffic is within 20-48 seconds of a potential collision area. If a Traffic Map is shown, and the TA traffic is beyond the selected map range, the system displays a half-TA symbol at the edge of the map at the approximate relative bearing of the TA traffic. If TA traffic subsequently meets the criteria for an RA, the system will issue an RA.
- **Resolution Advisory (RA)**, displayed as a filled red square, indicates traffic is within 15-35 seconds of a potential collision area. If a Traffic Map is shown, and the RA traffic is beyond the selected map range, the system displays a half-RA symbol at the edge of the map positioned at the approximate relative bearing to the RA traffic.

Foreword

Getting Started

Audio & Xpdr Ctrl

Com/Nav

FPL

Direct-To

Proc

Charts

Wpt Info

Map

Traffic

Terrain

Weather

Nearest

Services/ Music

Utilities

System

Messages

Symbols

Appendix

Index







Symbol	Description
	Other Non-threat Traffic
	Proximity Advisory (PA)
	Traffic Advisory (TA)
	Off-scale Traffic Advisory
	Resolution Advisory (RA)
	Off-scale Resolution Advisory

Table 10-18 TCAS II Traffic Symbol Description

10.9.2 TCAS II with ADS-B

When the GTS 8000 TCAS II is in operating mode, it interrogates Mode-S transponder data while automatically receiving ADS-B position and velocity information directly from a comparably equipped aircraft target. The system attempts to match (or “correlate”) the two surveillance data sources to increase the preciseness of its target location. When a correlation is made, the system displays the traffic information for the source determined to be the most accurate. Any traffic that is not correlated (i.e., only detected by one system but not the other) is also displayed for the flight crew. This may occur, for example, if another aircraft is beyond the surveillance range of the TCAS II, but the GTS 8000 is still receiving position and velocity information from other ADS-B equipped aircraft. The traffic correlation feature improves the accuracy of the traffic displayed, while reducing the occurrence of displaying a single target twice.



NOTE: Aircraft that are surveilled by ADS-B In only will not trigger a TCAS resolution advisory.

10.9.3 TCAS II Alerts

When the TCAS II unit issues a TA or RA, the following occur:

- A ‘TRAFFIC’ annunciation appears in the annunciator bar of the GTN, flashes for 5 seconds and remains displayed until no TAs or RAs are detected in the surveillance area.
 - RA ‘TRAFFIC’ annunciations are white text with red backgrounds.
 - TA ‘TRAFFIC’ annunciations are black text with yellow backgrounds.
 - If a TA and RA occur simultaneously, only the red and white RA ‘TRAFFIC’ annunciation is shown.
- If the GTN is not displaying the traffic page, the system displays a traffic alert pop-up.
- During a TA event, the system issues a single “Traffic, Traffic” voice alert each time the system detects a new TA threat.
- During an RA event, voice alert(s) provide vertical guidance to resolve the traffic conflict.
 - The Vertical Speed Indicator displays a range of vertical speeds to fly to or avoid as applicable.
 - Additional voice alerts occur if the RA status changes and when the aircraft is clear of the conflict.

If the traffic system cannot determine the bearing of a Traffic or Resolution Advisory, the alert will be displayed as a traffic alert banner outlined in the following table:

Foreword

Getting Started

Audio & Xpdr Ctrl

Com/Nav

FPL

Direct-To

Proc

Charts

Wpt Info

Map

Traffic

Terrain

Weather

Nearest

Services/ Music

Utilities

System

Messages

Symbols

Appendix

- Foreword
- Getting Started
- Audio & Xpdr Ctrl
- Com/Nav
- FPL
- Direct-To
- Proc
- Charts
- Wpt Info
- Map
- Traffic**
- Terrain
- Weather
- Nearest
- Services/ Music
- Utilities
- System
- Messages
- Symbols
- Appendix

Traffic Alert Banner	Description
RA X.X ± XX <UP> or <DN>	<ul style="list-style-type: none"> Warning banner displayed when system unable to determine bearing of Resolution Advisory (RA) and extreme pilot vigilance is required. Banner indicates distance in nm and altitude separation in hundreds of feet. If altitude trend is available, banner indicates altitude trend up <UP> for climbing and down <DN> for descending traffic.
TA X.X ± XX <UP> or <DN>	<ul style="list-style-type: none"> Caution banner displayed when system unable to determine bearing of Traffic Advisory (TA) and pilot vigilance is required. Banner indicates distance in nm and altitude separation in hundreds of feet. If altitude trend is available, banner indicates altitude trend up <UP> for climbing and down <DN> for descending traffic.

Table 10-19 TCAS II No Bearing Alert Banners

10.9.3.1 Resolution Advisories

Resolution Advisories (RAs) are TCAS II recommended vertical guidance maneuvers to be flown to resolve a traffic conflict. If the targeted threat aircraft is also TCAS II equipped, the two traffic systems use Mode S data link interrogations to generate complimentary responses to the RAs. During an RA event, the system monitors the performance and status of the aircraft response. It may command an increase/decrease vertical speed, and/or reverse climb/descend commands until the aircraft is clear of the conflict.

RAs are categorized in two resolution types: preventive and corrective:

Preventive Resolutions

Preventive RAs are issued when the aircraft's present vertical speed will resolve a traffic conflict. The system displays a range of vertical speed avoidance limits. These limits are displayed to help the pilot from climbing or descending into conflicting traffic.

Corrective Resolutions

Corrective RAs are issued when the aircraft's present vertical speed will not resolve a traffic conflict. The VSI indicates a range of vertical speeds to be avoided, while the current vertical speed appears in white with a red background. For advisory, the VSI indicates a green “fly to” vertical speed range that needs to be flown to resolve the RA conflict. In some cases, the TCAS II system logic determines it will be necessary to cross through the intruder aircraft's altitude to resolve the traffic conflict.

Foreword

Getting Started

Audio & Xpdr Ctrl

Com/Nav

FPL

Direct-To

Proc

Charts

Wpt Info

Map

Traffic

Terrain

Weather

Nearest

Services/ Music

Utilities

System

Messages

Symbols

Appendix

The following tables illustrate Preventive Advisories, Corrective Advisories, and TCAS II Voice Alerts.

Preventive RA Type	Required Vertical Speed (fpm)
Do Not Climb	< 0
Do Not Climb > 500 fpm	< 500
Do Not Climb > 1,000 fpm	< 1,000
Do Not Climb > 2,000 fpm	< 2,000
Do Not Descend	> 0
Do Not Descend > 500 fpm	> -500
Do Not Descend > 1,000 fpm	> -1,000
Do Not Descend > 2,000 fpm	> -2,000

Table 10-20 Preventative RA Types with Required Vertical Speeds

Corrective RA Type	Required Vertical Speed (fpm)
Climb	1,500 to 2,000
Crossing Climb	
Crossing Maintain Climb	1,500 to 4,400
Maintain Climb	
Reduce Descent	0
Descend	-1,500 to -2,000
Crossing Descend	
Crossing Maintain Descent	-1,500 to -4,400
Maintain Descent	
Reduce Climb	0

Table 10-21 Corrective RA Types with Required Vertical Speeds

Foreword
Getting Started
Audio & Xpdr Ctrl
Com/Nav
FPL
Direct-To
Proc
Charts
Wpt Info
Map
Traffic
Terrain
Weather
Nearest
Services/Music
Utilities
System
Messages
Symbols
Appendix
Index

Alert Type	Voice Alert
TA	"Traffic, Traffic"
Climb RA	"Climb, Climb"
Descend RA	"Descend, Descend"
Altitude Crossing Climb RA	"Climb, Crossing Climb, Climb, Crossing Climb"
Altitude Crossing Descend RA	"Descend, Crossing Descend, Descend, Crossing Descend"
Reduce Climb RA	"Level Off, Level Off"
Reduce Descend RA	"Level Off, Level Off"
RA Reversal to Climb RA	"Climb - Climb NOW, Climb - Climb NOW"
RA Reversal to Descend RA	"Descend - Descend NOW, Descend - Descend NOW"
Increase Climb RA	"Increase Climb, Increase Climb"
Increase Descent RA	"Increase Descent, Increase Descent"
Maintain Rate RA	"Maintain Vertical Speed, Maintain"
Altitude Crossing, Maintain Rate RA (Climb and Descend)	"Maintain Vertical Speed, Crossing Maintain"
Preventive RA	"Monitor Vertical Speed"
RA Removed	"Clear of Conflict"

Table 10-22 TCAS II Voice Alerts

10.9.4 TCAS II System Test

The TCAS II system test is initiated from the traffic menu. During a TCAS II system test, the system displays a traffic test pattern on the Traffic Page. A Resolution Advisory (RA) alert annunciation will be displayed with the vertical speed indicator indicating not to descend nor climb greater than 2,000 feet per minute. The system test takes approximately eight seconds to complete.

Condition	Voice Alert
System Test Passed	"TCAS Two System Passed"
System Test Failed	"TCAS Two System Failed"

Table 10-23 GTS 8000 System Test Voice Alerts

10.9.5 TCAS II Operation

To display TCAS II traffic, the system must be in TA ONLY or TA/RA Mode. These modes can be accessed from the transponder control panel or the Traffic Page Menu.

The Traffic Map is the principal map page for viewing TCAS II traffic data. Traffic data is displayed in relation to the aircraft's current position and altitude, without basemap clutter. Aircraft orientation is always heading up unless there is no valid heading. The map range is adjustable from 2 to 40 nm. Its scale is indicated by the map range rings.

The traffic operating mode and altitude display mode are annunciated in the upper left corner of the Traffic Map Page.



Figure 10-36 TCAS II Traffic Map Page

NOTE: The GTS 8000 TCAS II system automatically selects TA ONLY Mode when the aircraft is below 1,000' AGL. After landing, the GTS 8000 automatically selects STANDBY Mode. If the installed TCAS II traffic system is not a GTS 8000, refer to the applicable documentation for system-specific automatic traffic mode selections.



10.9.5.1 Altitude Display

The flight crew can select the volume of airspace in which Other Non-Threat and proximity traffic is displayed. TAs and RAs outside of these limits will always be shown. This airspace can be selected by pressing the **Altitude Filter** button on the traffic page.

Altitude Mode	Displayed Traffic Range
Below	-9,900 ft to 2,700 ft
Normal	-2,700 ft to 2,700 ft
Above	-2,700 ft to 9,900 ft
Unrestricted	-9,900 ft to 9,900 ft

Table 10-24 Displayed Traffic Range

10.9.5.2 Traffic System Status

The traffic mode is annunciated in the upper left corner of the Traffic Map pane. If the traffic system fails, or is in test mode, an annunciation is shown in the center of the Traffic Map.

Operating Mode	Traffic Page Annunciations	Traffic Page Banner
TCAS II Self-Test Initiated (TEST)	Test	Test Mode
Traffic and Resolution Advisory (TA/RA)	TA/RA	N/A
Traffic Advisory Only	TA Only	N/A
TCAS II Standby	STBY	N/A
TCAS II Failed	Fail	Failed or No Data

Table 10-25 TCAS II Modes

10.9.5.3 External Display

If an external traffic display is being controlled by the GTN, it will be commanded to match the display settings on the GTN (traffic range and altitude filter). In a dual GTN installation, GTN #1 will control the external display. The traffic range on the external display will be set to the nearest range to the selected range on the GTN.

Foreword

Getting
Started

Audio &
Xpdr Ctrl

Com/Nav

FPL

Direct-To

Proc

Charts

Wpt Info

Map

Traffic

Terrain

Weather

Nearest

Services/
Music

Utilities

System

Messages

Symbols

Appendix

This page intentionally left blank

11.1 Terrain Configurations



NOTE: Obstacles are removed from the Terrain and TAWS pages at ranges greater than 10 NM.

During power-up of the GTN 7XX, the terrain/obstacle database versions are displayed along with a disclaimer. At the same time, the Terrain system self-test begins. A failure message is issued if the terrain test fails.

Garmin provides multiple terrain awareness solutions within the GTN 7XX environment.

Alerting functions are designed to increase situational awareness and help reduce controlled flight into terrain (CFIT).

Terrain Type	Features
(H)Terrain Proximity	<ul style="list-style-type: none"> Standard terrain function displaying relative elevations on moving map Does not provide aural or visual alerts
(H)Terrain Alerting	<ul style="list-style-type: none"> Basic terrain alerting function Provides aural and visual alerts Does not meet TSO-C151c or TSO-C194 requirements for certification
HTAWS	<ul style="list-style-type: none"> Optional terrain alerting function for rotorcraft Satisfies TSO-C194 requirements for certification
TAWS-A	<ul style="list-style-type: none"> Optional TSO-C151c Class A terrain alerting system Provides aural and visual alerts when terrain and obstacles are within a given altitude threshold from the aircraft
TAWS-B	<ul style="list-style-type: none"> Optional TSO-C151c Class B terrain alerting system Provides aural and visual alerts

Table 11-1 Terrain Configurations

11.2 GPS Altitude for Terrain

GPS altitude is derived from satellite measurements. To require an accurate 3-D fix (latitude, longitude, altitude), a minimum of four operating satellites must be in view of the GPS receiver antenna.

The terrain system uses GPS altitude and position data to:

- Create a 2-D image of surrounding terrain and obstacles relative to the aircraft's position and altitude
- Calculate the aircraft's flight path in relation to surrounding terrain and obstacles
- Predict hazardous terrain conditions and issue alerts

11.2.1 GSL Altitude & Indicated Altitude

The GTN converts GPS altitude data to GSL altitude (i.e., the geometric altitude relative to MSL) for use in terrain functions. All Terrain page depictions and elevation indications are in GSL.

Variations between GSL altitude and the aircraft's corrected barometric altitude (or indicated altitude) are common. As a result, Terrain page altitude data may differ from current altimeter readings. Both GSL altitude and indicated altitude represent height above MSL, but differ in accuracy and reliability.

Altitude Type	Features
GSL	<ul style="list-style-type: none"> • Highly accurate and reliable geometric altitude source • Does not require local altimeter settings to determine height above MSL • Not subject to pressure and temperature variations • Affected primarily by satellite geometry
Indicated	<ul style="list-style-type: none"> • Barometric altitude source corrected for pressure variations • Requires frequent altimeter setting adjustment to determine height above MSL • Subject to local atmospheric conditions • Affected by variations in pressure, temperature, and lapse rate

Table 11-2 GSL and Indicated Altitude Features

11.3 General Database Information

Garmin TAWS and HTAWS use terrain and obstacle information supplied by government and private sources. The data undergoes verification by Garmin to confirm accuracy of the content. **However, the displayed information should never be understood as being all-inclusive. Pilots must familiarize themselves with the appropriate charts for safe flight.**



NOTE: The data contained in the terrain and obstacle databases comes from government and private agencies. Garmin accurately processes and cross-validates the data, but cannot guarantee its accuracy or completeness.

11.3.1 Database Versions

The version and area of coverage of each terrain/obstacle database is shown on the System-System Status page. Databases are checked for integrity at power-up. If a database is found to be missing and/or deficient, the TAWS/HTAWS system fails the self-test and displays the TAWS/HTAWS system failure message.

11.3.2 HTAWS Database Requirements

To function properly, HTAWS requires the use of databases specific to helicopters and HTAWS. The databases required are:

- 2.5 arc-second Terrain Database
- Helicopter Obstacle Database
- Helicopter Navigation Database

11.3.3 Database Updates

For information on how to update databases, refer to section 19.2.

11.3.4 Terrain Database Areas of Coverage

The fixed-wing terrain database provides worldwide coverage. The following describes the area of coverage available in each helicopter terrain database. Regional definitions may change without notice.

Database	Coverage Area
Americas - North	Latitudes: 0° to N90° Longitudes: W180° to W30°
Americas - South	Latitudes: N30° to S90° Longitudes: W180° to W30°
Atlantic - North	Latitudes: 0° to N90° Longitudes: W30° to E90°
Atlantic - South	Latitudes: N30° to S90° Longitudes: W30° to E90°
Pacific - North	Latitudes: 0° to N90° Longitudes: E60° to E180°
Pacific - South	Latitudes: N30° to S90° Longitudes: E60° to E180°

Table 11-3 Terrain Database Coverage



NOTE: Because of higher resolution helicopter terrain data, the world-wide data won't fit on the terrain database card. Therefore, data is regionalized. If you have the wrong region database for your present position, then you get the message that terrain is unavailable for the current location and a crosshatched pattern on the terrain display.

11.3.5 Obstacle Database Areas of Coverage

The following describes the area of coverage available in each database. Regional definitions may change without notice.

Database	Coverage Area
United States (US)	Limited to the United States plus some areas of Canada, Mexico, Caribbean, and the Pacific.
US/Europe	Alaska, Austria, Belgium, Canada*, Caribbean*, Czech Republic, Denmark, Estonia, Finland, France, Germany, Greece, Hawaii, Iceland, Ireland, Italy, Latvia, Lithuania, Mexico*, Netherlands, Norway, Poland, Portugal, Slovakia, Spain, Sweden, Switzerland, United Kingdom, United States
* Indicates partial coverage	

Table 11-4 Obstacle Database Coverage



NOTE: *It is very important to note that not all obstacles are necessarily charted and therefore may not be contained in the Obstacle Database.*

Obstacle databases created for GTN software v5.10 or later include all power lines or only HOT lines depending on the type of obstacle database installed. Hazardous Obstacle Transmission (HOT) Lines are those power lines that are co-located with other FAA-identified obstacles. The installed obstacle database type can be verified on the System Status page. Power line data is available for the contiguous United States as well as small parts of Canada and Mexico.

11.4 Terrain Proximity

Garmin Terrain Proximity is a non-TSO-C151c-certified terrain awareness system provided as a standard feature of GTN 7XX to increase situational awareness and help reduce controlled flight into terrain (CFIT). Terrain may be displayed on the Map and Terrain pages.

Terrain Proximity uses information provided from the GPS receiver to provide a horizontal position and altitude. GPS altitude is derived from satellite measurements. GPS altitude is converted to a Mean Sea Level (MSL)-based altitude (GSL altitude) and is used to determine Terrain alerts. GSL altitude accuracy is affected by factors such as satellite geometry, but it is not subject to variations in pressure and temperature that normally affect pressure altitude devices. GSL altitude does not require local altimeter settings to determine MSL altitude. Therefore, GPS altitude provides a highly accurate and reliable MSL altitude source to calculate terrain and obstacle alerts.

Terrain utilizes terrain and obstacle databases that are referenced to mean sea level (MSL). Using the GPS position and GSL altitude, Terrain displays a 2-D picture of the surrounding terrain and obstacles relative to the position and altitude of the aircraft. In this manner, Terrain Proximity can provide advanced alerts of predicted dangerous terrain conditions.

Terrain requires the following to operate properly:

- The system must have a valid 3-D GPS position solution.
- The system must have a valid terrain/obstacle database.

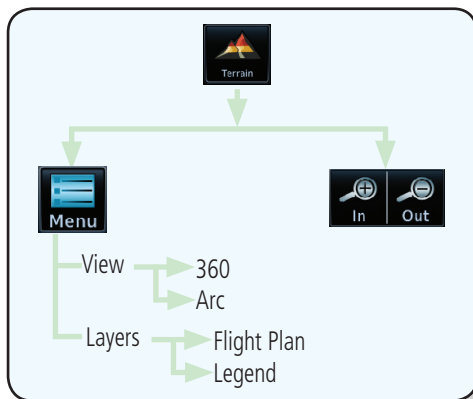

Figure 11-1 Terrain Proximity Page Functional Diagram

Foreword
Getting Started
Audio & Xpdr Ctrl
Com/Nav
FPL
Direct-To
Proc
Charts
Wpt Info
Map
Traffic
Terrain
Weather
Nearest
Services/ Music
Utilities
System
Messages
Symbols
Appendix

11.4.1 Displaying Terrain Proximity

The Terrain page is in the Terrain function.



1. Touch the **Terrain** key on the Home page.

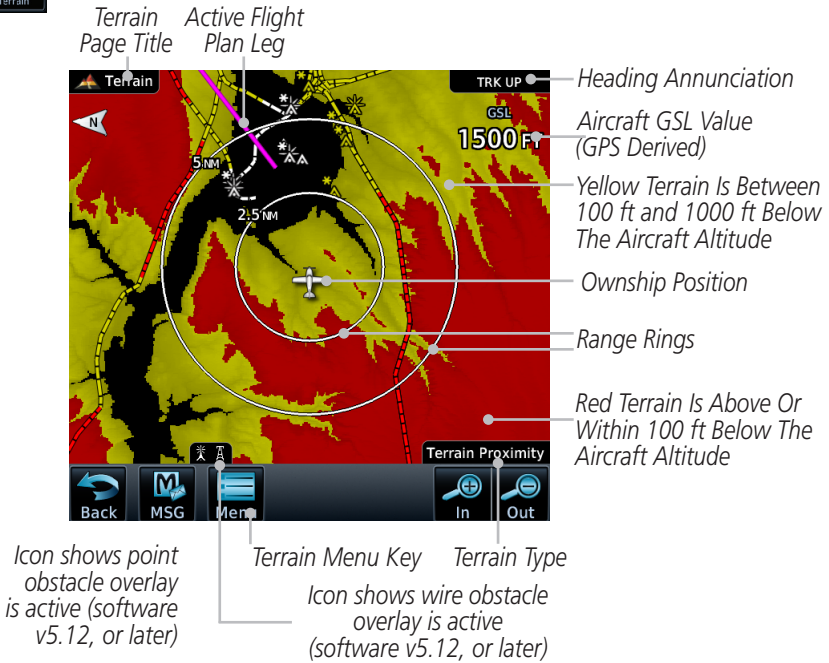

Figure 11-2 Terrain Page



2. Touch the **Menu** key for options.

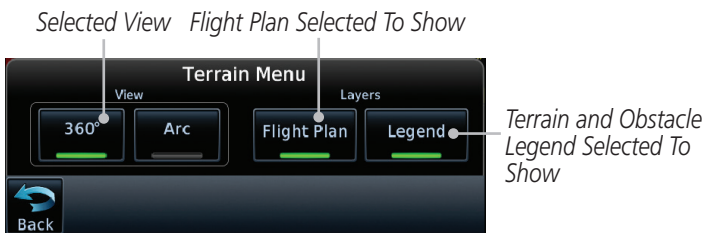

Figure 11-3 Terrain Menu Options

11.4.1.1 Terrain Page 120° Arc or 360° Rings

Select the 120° Arc or 360° rings overlay for the Terrain page with either the **360** or **Arc** keys from the Menu.



1. While viewing the Terrain page, touch the **Menu** key.

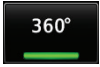

2. Touch the **360°** or **Arc** key.

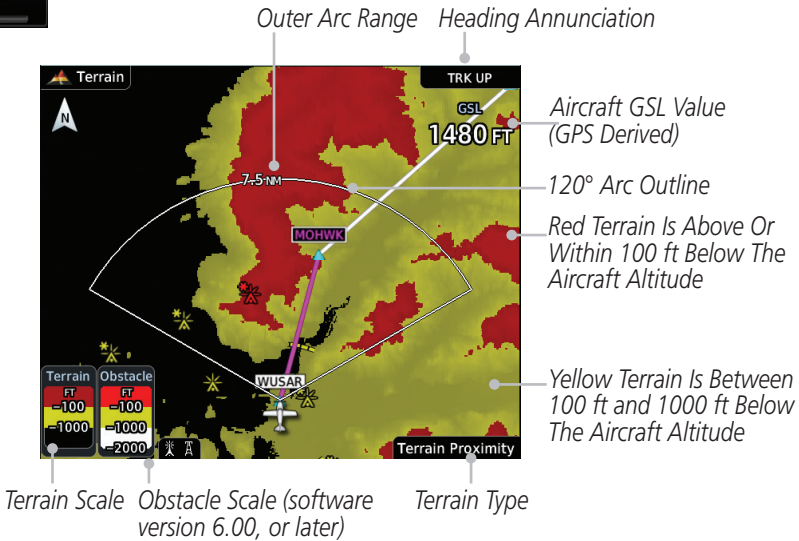
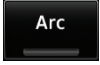
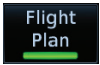

Figure 11-4 Terrain 120° Arc View

11.4.1.2 Display Flight Plan on Terrain Page

Select the display of the active flight plan on the Terrain page.



Touch the **Flight Plan** key to toggle the display of active flight plan on or off.

11.4.1.3 Display Terrain and Obstacle Legend

Select the display of the Terrain Legend on the Terrain page.

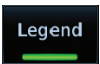

Touch the **Legend** key to toggle the display of the Terrain Legend on or off.

11.4.2 Terrain Limitations

Terrain Proximity displays terrain and obstructions relative to the altitude of the aircraft. The displayed alerts are advisory in nature only. Individual obstructions may be shown if available in the database. However, all obstructions may not be available in the database and data may be inaccurate. Terrain information should be used as an aid to situational awareness. Never use this information for navigation or to maneuver to avoid obstacles.

Terrain Proximity uses terrain and obstacle information supplied by government sources. The displayed information should never be understood as being all-inclusive.



NOTE: *The data contained in the Terrain databases comes from government agencies. Garmin accurately processes and cross-validates the data but cannot guarantee its accuracy or completeness.*



NOTE: *TERRAIN, TAWS-A, TAWS-B, HTAWS, or HTERRAIN PROXIMITY functionality will be available via the Terrain page, depending on the installed hardware and configuration. HTAWS or HTERRAIN PROXIMITY are available in software v4.00, or later. TAWS-A is available in software v5.00, or later.*

11.5 Terrain Alerting

Terrain alerting functions increase situational awareness and help reduce controlled flight into terrain (CFIT). Visual and aural annunciations alert the pilot when terrain and obstacles are within the given altitude threshold from the aircraft.

11.5.1 Terrain Alerting Requirements

- A valid terrain/obstacle database
- A valid 3-D GPS position solution

11.5.2 Terrain Alerting Limitations



NOTE: *The data contained in the databases comes from government agencies. Garmin accurately processes and cross-validates the data but cannot guarantee its accuracy or completeness.*

Terrain alerting uses terrain and obstacle information supplied by government sources. Terrain information is based on terrain elevation information in a database that may contain inaccuracies. Individual obstructions may be shown if available in the database. The data undergoes verification by Garmin to confirm accuracy of the content.

- Foreword
- Getting Started
- Audio & Xpdr Ctrl
- Com/Nav
- FPL
- Direct-To
- Proc
- Charts
- Wpt Info
- Map
- Terrain
- Traffic
- Weather
- Nearest
- Services/ Music
- Utilities
- System
- Messages
- Symbols
- Appendix
- Index

11.5.3 Using Terrain Alerting

During unit power-up, the terrain/obstacle database versions are displayed. At the same time, the terrain system self-test begins, and one of the following aural messages is generated:

- “Terrain System Test OK”
- “Terrain System Failure”

On the Map page, terrain and obstacles with heights greater than 200 feet Above Ground Level (AGL) display in yellow and red. The GTN 7XX adjusts colors automatically as the aircraft altitude changes.

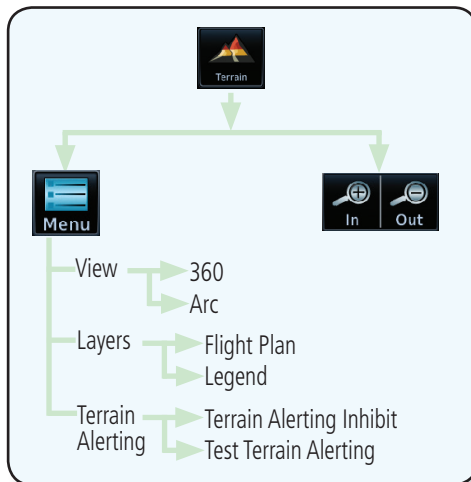

Figure 11-5 Terrain Alerting Page Functional Diagram

11.5.4 Displaying Terrain Alerting Data

Terrain uses yellow (caution) and red (warning) to depict terrain and obstacles alerts relative to aircraft altitude. Colors are adjusted automatically as the aircraft altitude changes. The colors and symbols shown below are used to represent terrain, obstacles, and threat locations. Obstacles are removed when more than 2000 ft below the aircraft.

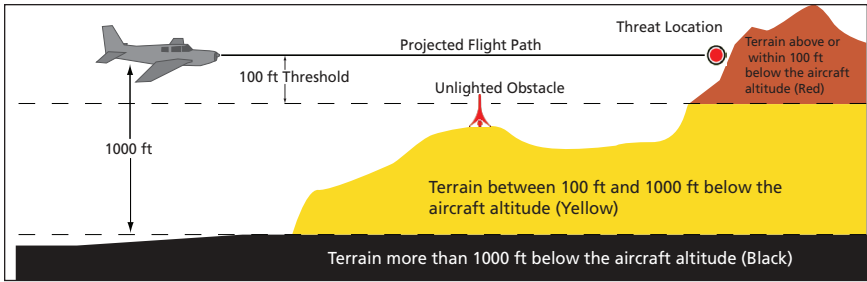

Figure 11-6 Terrain Altitude/Color Correlation

Obstacle Symbol	Unlighted Obstacle		Lighted Obstacle		Threat Location Indicator	Terrain Color	Terrain/Obstacle Location	Alert Level
	< 1000 ft AGL	> 1000 ft AGL	< 1000 ft AGL	> 1000 ft AGL				
					Red	Terrain/Obstacle at or within 100 ft below current aircraft altitude	WARNING (Red)	
					Yellow	Terrain/Obstacle between 100 ft and 1000 ft below current aircraft altitude	CAUTION (Yellow)	
					White	Terrain/Obstacle between 1000 ft and 2000 ft below current aircraft altitude		

Table 11-5 Terrain/Obstacle Colors and Symbology

Tower	Windmill	Windmill in Group	Power Line

Table 11-6 Obstacle Icon Types

Grouped obstacles are shown with an asterisk (as shown in the Windmill in Group example above). The color of the asterisks is tied to the relative altitude of the highest obstacle in the group, not other obstacles within that group. Obstacles are grouped when they would otherwise overlap.

11.5.5 Terrain Page

Terrain information is displayed on the Map and Terrain pages. The Terrain page is specialized to show terrain, obstacle, and threat location data in relation to the aircraft's current altitude, without clutter from the basemap. Flight plan information (airports, VORs, and other NAVAIDs) included in the flight plan are displayed for reference. If an obstacle and the projected flight path of the aircraft intersect, the display automatically zooms in to the closest threat location on the Terrain page.

Aircraft orientation on this map is always heading up unless there is no valid heading. If orientation is not heading up, it will be track up. Two views are available relative to the position of the aircraft: the 360° default display and the radar-like ARC (120°) display. Map range is adjustable with the **In** and **Out** keys from 1 to 200 NM, as indicated by the map range rings (or arcs).

11.5.5.1 Terrain Page Layers



1. While viewing the Terrain page, touch the **Menu** key.

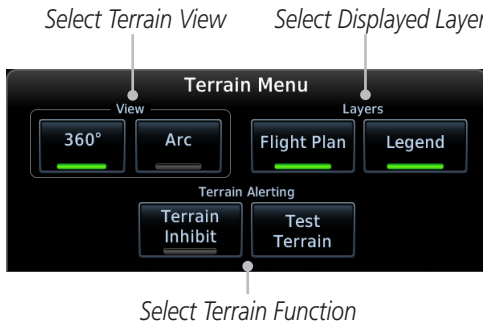
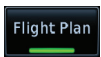

Figure 11-7 Terrain Menu



2. Touch the **Flight Plan** key to toggle the display of the active flight plan.

Foreword
Getting Started
Audio & Xpdr Ctrl
Com/Nav
FPL
Direct-To
Proc
Charts
Wpt Info
Map
Traffic
Terrain
Weather
Nearest
Services/
Music
Utilities
System
Messages
Symbols
Appendix
Index

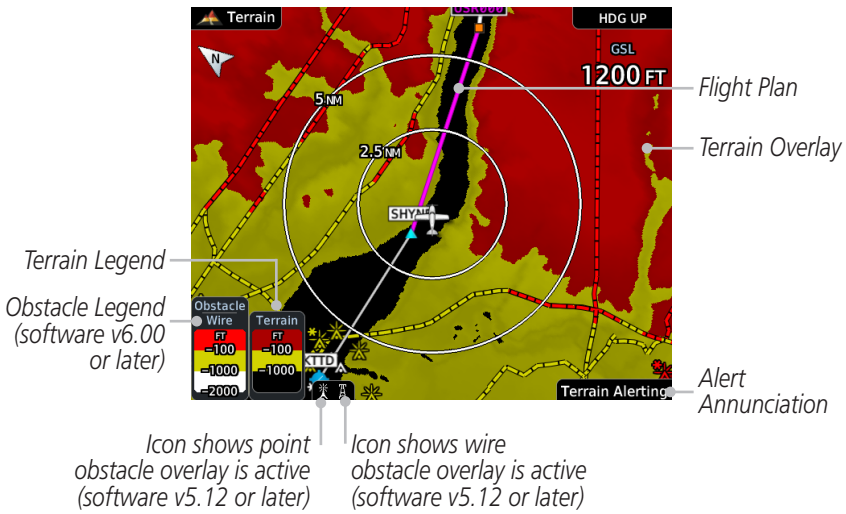

Figure 11-8 Flight Plan and Legend Shown On Terrain Page

3. Touch the **Legend** key to toggle the display of the Terrain and Obstacle legend.

11.5.5.2 Terrain Page View

Select the 120° Arc or 360° rings overlay for the Terrain page with either the **360** or **Arc** keys from the Menu.

1. While viewing the Terrain page, touch the **Menu** key.
2. Touch the **360°** or **Arc** key.

11.5.5.3 Terrain Alerting Selections

An inhibit function allows you to manually inhibit aural terrain alerts. After cycling power, terrain alerting functions will no longer be inhibited.

1. While viewing the Terrain page, touch the **Menu** key.
2. Touch the **Terrain Inhibit** key to toggle the inhibiting of terrain alerts.
3. Touch the **Test Terrain** key to perform an internal test of the terrain alerting system. This function is not available when the aircraft is in the air.

11.5.6 Terrain Alerts

Alerts are issued when flight conditions meet parameters that are set within terrain alerting software algorithms. When an alert is issued, visual annunciations are displayed and aural alerts are simultaneously issued. Alert types are shown in the Terrain Alerts Summary with corresponding annunciations and aural messages.

When an alert is issued, annunciations appear on the Terrain page. If the page is not displayed at the time, a pop-up alert appears over the page being viewed.

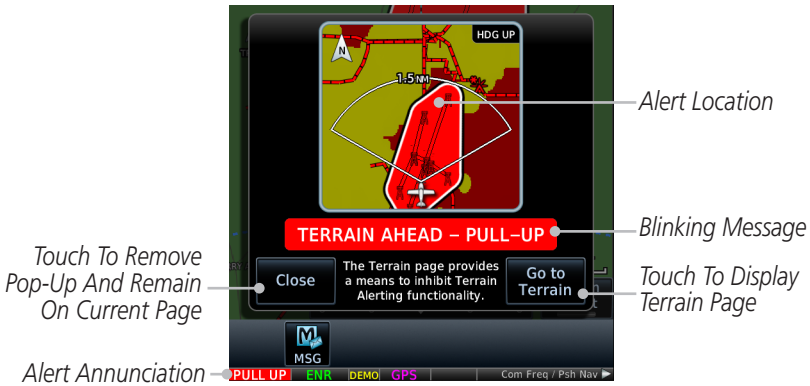
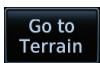

Figure 11-9 Terrain Alert Pop-Up

To acknowledge the pop-up alert:



Touch the **Go to Terrain** key (accesses the Terrain page)

OR

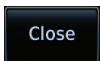

Touch the **Close** key to remove the pop-up alert

If the pilot takes no action, the pop-up will be removed when the alert is no longer active.

11.5.6.1 Terrain Alerting Colors and Symbology

Color and symbols are also associated with terrain alerts. The alert annunciations show in the bottom left corner of the display. The three alert levels and their associated text coloring as well as any associated symbology are shown in the following table.



Alert Level	Annunciator Text	Threat Location Indicator	Example Visual Annunciation
Warning	White text on red background		PULL UP
Caution	Black text on yellow background		TERRAIN
Informational	Black text on white background	Not Applicable	TER INHB

Table 11-7 Terrain Alert Colors and Symbology

Alert Type	Alert Annunciation	Aural Message
FLTA Terrain Warning (RTC-W, ITI-W)	PULL UP	"Terrain Ahead, Pull Up; Terrain Ahead, Pull Up"* or "Terrain, Terrain; Pull Up, Pull Up"
FLTA Obstacle Warning (ROC-W, IOI-W)	PULL UP	"Obstacle Ahead, Pull Up; Obstacle Ahead, Pull Up"* or "Obstacle, Obstacle; Pull Up, Pull Up"
FLTA Wire Warning (ILI-W, RLC-W)	PULL UP	"Wire Ahead Pull Up, Wire Ahead Pull Up"
FLTA Terrain Caution (RTC-C, ITI-C)	TERRAIN	"Terrain Ahead; Terrain Ahead"* or "Caution, Terrain; Caution, Terrain"
FLTA Obstacle Caution (ROC-C, IOI-C)	OBSTCL	"Obstacle Ahead; Obstacle Ahead"* or "Caution, Obstacle; Caution, Obstacle"
FLTA Wire Caution (ILI-C, RLC-C)	WIRE	"Wire Ahead"
Premature Descent Alert Caution (PDA)	TERRAIN	"Too Low, Terrain"

Alert Type	Alert Annunciation	Aural Message
Voice Call Out (VCO-500)	None	"Five-Hundred"

* Alerts with multiple messages are configurable at installation and are installation-dependent. Alerts for the default configuration are indicated with asterisks.

Table 11-8 Alerts Summary

11.5.6.2 Forward Looking Terrain Avoidance

Reduced Required Terrain Clearance (RTC), Reduced Required Line Clearance (RLC), and Reduced Required Obstacle Clearance (ROC) alerts are issued when the aircraft flight path is above terrain, yet is projected to come within the minimum clearance values in the FLTA Alert Minimum Terrain and Obstacle Clearance Values table. When an RTC, RLC, and/or a ROC alert is issued, a threat location indicator is displayed on the Terrain page.

Imminent Terrain Impact (ITI), Imminent Line Impact (ILI), and Imminent Obstacle Impact (IOI) alerts are issued when the aircraft is below the elevation of a terrain or obstacle cell in the aircraft's projected path. ITI, ILI, and IOI alerts are accompanied by a threat location indicator displayed on the Terrain page. The alert is annunciated when the projected vertical flight path is calculated to come within minimum clearance altitudes in the following table.

Flight Phase	Minimum Clearance Altitude (feet)	
	Level Flight	Descending
En Route	700	500
Terminal	350	300
Approach	150	100
Departure	100	100

Table 11-9 FLTA Alert Minimum Terrain and Obstacle Clearance Values

During final approach, FLTA alerts are automatically inhibited when the aircraft is below 200 feet AGL while within 0.5 NM of the approach runway or below 125 feet AGL while within 1.0 NM of the runway threshold.

11.5.6.3 Premature Descent Alerting

A Premature Descent Alert (PDA) is issued when the system detects that the aircraft is significantly below the normal approach path to a runway.

PDA alerting begins when the aircraft is within 15 NM of the destination airport and ends when the aircraft is either 0.5 NM from the runway threshold or is at an altitude of 125 feet AGL while within 1.0 NM of the threshold. During the final descent, algorithms set a threshold for alerting based on speed, distance, and other parameters.

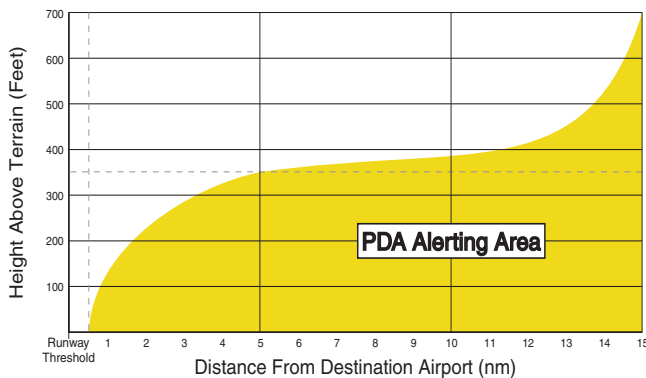

Figure 11-10 PDA Alerting Threshold

PDA and FLTA aural and visual alerts can be manually inhibited. Discretion should be used when inhibiting terrain alerts and the system should be enabled when appropriate. When terrain alerting is inhibited, the alert annunciation “TER INHB” is shown.

11.5.6.4 Inhibiting/Enabling PDA/FLTA Alerting

Inhibit mode deactivates the PDA/FLTA aural and visual alerts. Pilots should use discretion when inhibiting terrain alerts and always remember to enable the system when appropriate. Only the PDA and FLTA alerts are disabled in the inhibit mode. After cycling power, the terrain alerting function will no longer be inhibited.

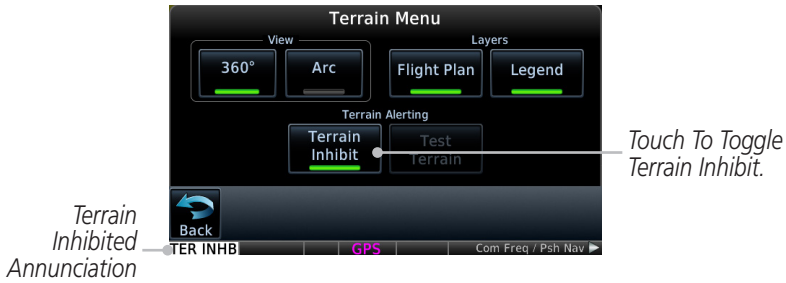

Figure 11-11 Terrain Alerting Inhibited Annunciation



1. While viewing the Terrain page, touch the **Menu** key.
2. Touch the **Terrain Inhibit** key to inhibit or enable terrain alerting (choice dependent on current state). A green bar in the key indicates the inhibit function is active.

11.5.6.5 Altitude Voice Call Out (VCO)

Terrain provides aural advisory alerts as the aircraft descends, beginning at 500 feet above the terrain, as determined by the radar altimeter (if greater than 5 NM from the nearest airport) or 500 feet above the nearest runway threshold elevation (if less than 5 NM from the nearest airport). Upon descent to this altitude, the terrain system issues the aural alert message “Five-hundred.”

11.5.6.6 Terrain Not Available Alert

Terrain requires a 3-D GPS position solution along with specific vertical accuracy minimums. Should the position solution become degraded or if the aircraft is out of the database coverage area, the annunciation “TER N/A” is generated in the annunciation window and on the Terrain page. The aural message “Terrain Not Available” is generated. When the GPS signal is re-established and the aircraft is within the database coverage area, the aural message “Terrain Available” is generated (when the aircraft is airborne).

11.5.6.7 Terrain Failure Alert

Terrain continually monitors several system-critical items such as database validity, hardware status, and GPS status. If the terrain/obstacle database is not available, the aural message “Terrain System Failure” is generated along with a “TER FAIL” annunciation.

11.5.7 Terrain System Status

During power-up, the terrain system conducts a self-test of its aural and visual annunciations. This test can also be manually initiated. An aural alert is issued at test completion. Terrain system testing is disabled when ground speed exceeds 30 knots.

Alert Type	Alert Annunciation	Aural Message
Terrain Available	None	"Terrain Available"
Terrain System Test in Progress	TER TEST	None
Terrain System Test Pass	None	"Terrain System Test OK"
Terrain N/A	TER N/A	Terrain Not Available
Terrain Alerting is Disabled	TER INHB	None
Terrain System Test Fail	TER FAIL	"Terrain System Failure"

Table 11-10 Terrain System Test Status Annunciations

11.6 TAWS-B (Optional)

TAWS (Terrain Awareness and Warning System) is an optional feature to increase situational awareness and aid in reducing controlled flight into terrain (CFIT). TAWS provides visual and aural annunciations when terrain and obstacles are within the given altitude threshold from the aircraft.

TAWS satisfies TSO-C151c Class B requirements for certification. Class B TAWS is required for all Part 91 turbine aircraft operations with six or more passenger seats and for Part 135 turbine aircraft operations with six to nine passenger seats (FAR Parts 91.223, 135.154).

11.6.1 TAWS-B Requirements

- A valid terrain/obstacle database
- A valid 3-D GPS position solution

11.6.2 TAWS-B Limitations



NOTE: *The data contained in the TAWS databases comes from government agencies. Garmin accurately processes and cross-validates the data but cannot guarantee its accuracy or completeness.*

TAWS displays terrain and obstructions relative to the altitude of the aircraft. Compliance with TAWS B alerts and warnings is MANDATORY. When a TAWS B “pull up” annunciation is issued, the pilot is required to pull up.

TAWS uses terrain and obstacle information supplied by government sources. Terrain information is based on terrain elevation information in a database that may contain inaccuracies. Individual obstructions may be shown if available in the database. The data undergoes verification by Garmin to confirm accuracy of the content, per TSO-C151c.

11.6.3 Using TAWS-B

During unit power-up, the terrain/obstacle database versions are displayed. At the same time, TAWS self-test begins, and one of the following aural messages is generated:

- “TAWS System Test OK”
- “TAWS System Failure”

TAWS information can be displayed on the Map page. Terrain and obstacles with heights greater than 200 feet Above Ground Level (AGL) are displayed in yellow and red. The GTN 7XX adjusts colors automatically as the aircraft altitude changes.

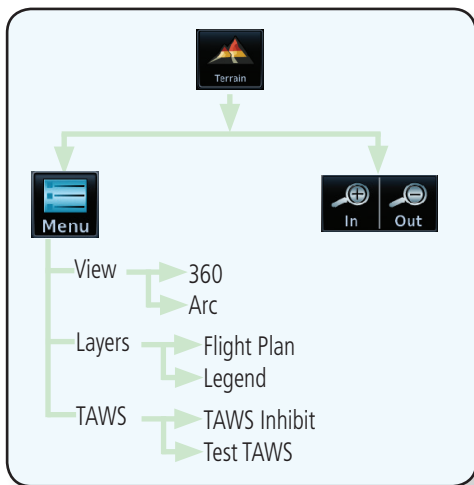

Figure 11-12 TAWS-B Page Functional Diagram

11.6.4 Displaying TAWS-B Data

TAWS uses yellow (caution) and red (warning) to depict terrain and obstacles alerts relative to aircraft altitude. Colors are adjusted automatically as the aircraft altitude changes. The colors and symbols shown below are used to represent terrain, obstacles, and threat locations. Obstacles are removed when more than 2000 ft below the aircraft.

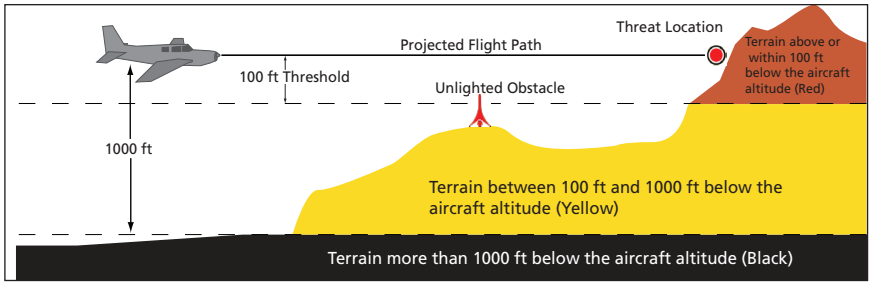

Figure 11-13 Terrain Altitude/Color Correlation for TAWS-B

Obstacle Symbol	Unlighted Obstacle		Lighted Obstacle		Threat Location Indicator	Terrain Color	Terrain/Obstacle Location	Alert Level
	< 1000 ft AGL	> 1000 ft AGL	< 1000 ft AGL	> 1000 ft AGL				
					Red	Terrain/Obstacle at or within 100 ft below current aircraft altitude	WARNING (Red)	
					Yellow	Terrain/Obstacle between 100 ft and 1000 ft below current aircraft altitude	CAUTION (Yellow)	
					White	Terrain/Obstacle between 1000 ft and 2000 ft below current aircraft altitude		

Table 11-11 TAWS-B Terrain/Obstacle Colors and Symbology

Tower	Windmill	Windmill in Group	Power Line

Table 11-12 Obstacle Icon Types

Grouped obstacles are shown with an asterisk (as shown in the Windmill in Group example above). The color of the asterisks is tied to the relative altitude of the highest obstacle in the group, not other obstacles within that group. Obstacles are grouped when they would otherwise overlap.

11.6.5 TAWS-B Page

TAWS information is displayed on the Map and Terrain pages. The TAWS Page is specialized to show terrain, obstacle, and threat location data in relation to the aircraft's current altitude, without clutter from the basemap. Flight plan information (airports, VORs, and other NAVAIDs) included in the flight plan are displayed for reference. If an obstacle and the projected flight path of the aircraft intersect, the display automatically zooms in to the closest threat location on the TAWS Page.

Aircraft orientation on this map is always heading up unless there is no valid heading. If orientation is not heading up, it will be track up. Two views are available relative to the position of the aircraft: the 360° default display and the radar-like ARC (120°) display. Map range is adjustable with the **In** and **Out** keys from 1 to 200 NM, as indicated by the map range rings (or arcs).

11.6.5.1 Terrain Page Layers

1. While viewing the Terrain page, touch the **Menu** key.

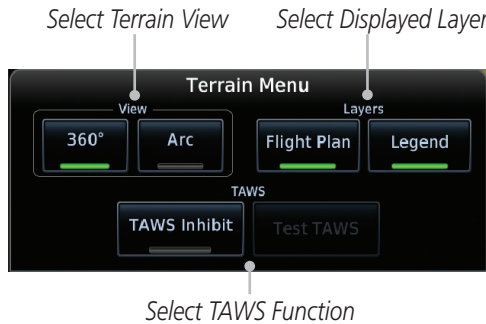
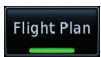

Figure 11-14 Terrain Page TAWS-B Menu

2. Touch the **Flight Plan** key to toggle the display of the active flight plan.



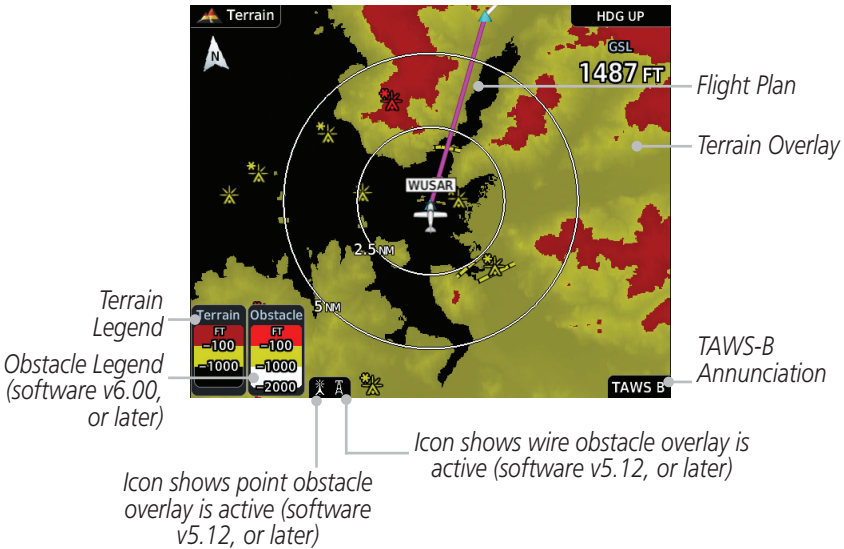
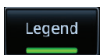

Figure 11-15 Flight Plan and Legend Shown On TAWS-B Terrain Page



3. Touch the **Legend** key to toggle the display of the Terrain and Obstacle legend.

11.6.5.2 Terrain Page View

Select the 120° Arc or 360° rings overlay for the Terrain page with either the **360** or **Arc** keys from the Menu.



1. While viewing the Terrain page, touch the **Menu** key.

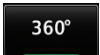

2. Touch the **360°** or **Arc** key.



11.6.5.3 Terrain Page TAWS-B Selections

The TAWS selections allow you to inhibit aural TAWS alerts and to send a request to the TAWS equipment to run its internal tests. After cycling power, TAWS will no longer be inhibited.



1. While viewing the Terrain page, touch the **Menu** key.



2. Touch the **TAWS Inhibit** key to toggle the inhibiting of TAWS alerts.

Foreword
Getting Started
Audio & Xpdr Ctrl
Com/Nav
FPL
Direct-To
Proc
Charts
Wpt Info
Map
Terrain
Weather
Nearest
Services/
Music
Utilities
System
Messages
Symbols
Appendix



Figure 11-16 TAWS-B Alerts Inhibited Selected

3. Touch the **Test TAWS** key to test the TAWS system. This function is not available when the aircraft is in the air.

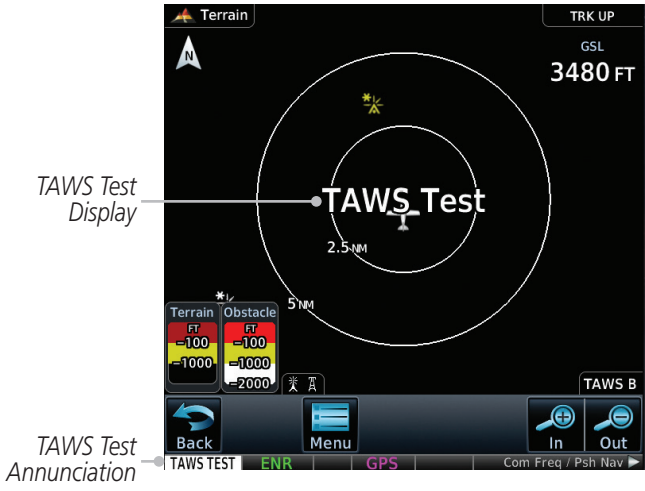

Figure 11-17 TAWS-B Test Selected

11.6.6 TAWS-B Alerts

Alerts are issued when flight conditions meet parameters that are set within TAWS software algorithms. When an alert is issued, visual annunciations are displayed and aural alerts are simultaneously issued. TAWS alert types are shown in the TAWS Alerts Summary with corresponding annunciations and aural messages.

When an alert is issued, annunciations appear on the TAWS page. If the TAWS page is not displayed at the time, a pop-up alert appears on the page being viewed.

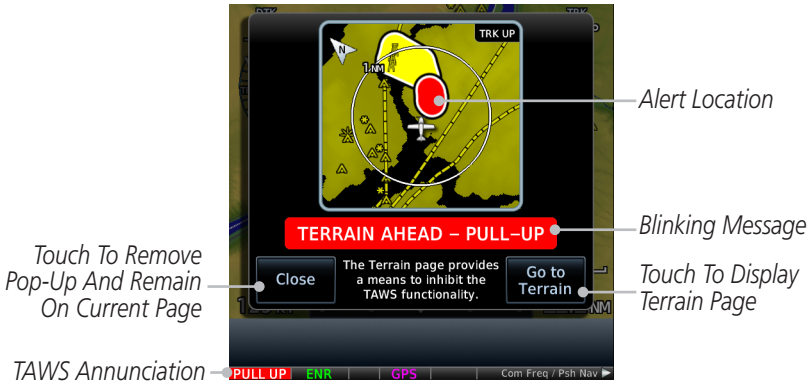
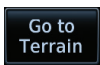

Figure 11-18 Terrain Alert Pop-Up

To acknowledge the pop-up alert:



Touch the **Go to Terrain** key (accesses the TAWS Page)

OR

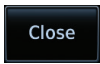

Touch the **Close** key to remove the pop-up alert

If the pilot takes no action, the pop-up will be removed when the alert is no longer active.

11.6.6.1 TAWS-B Alerting Colors and Symbology

Color and symbols are also associated with TAWS alerts. The alert annunciations show in the bottom left corner of the display. The three TAWS alert levels and their associated text coloring as well as any associated symbology are shown in the following table.

Alert Level	Annunciator Text	Threat Location Indicator	Example Visual Annunciation
Warning	White text on red background		PULL UP
Caution	Black text on yellow background		TERRAIN
Informational	Black text on white background	Not Applicable	TAWS INHB

Table 11-13 TAWS-B Alert Colors and Symbology

Foreword

Getting Started

Audio & Xpdr Ctrl

Com/Nav

FPL

Direct-To

Proc

Charts

Wpt Info

Map

Traffic

Terrain

Weather

Nearest

Services/
Music

Utilities

System

Messages

Symbols

Appendix

Alert Type	Alert Annunciation	Aural Message
Excessive Descent Rate Warning (EDR-W)	PULL UP	"Pull Up"
FLTA Terrain Warning (RTC-W, ITI-W)	PULL UP	"Terrain Ahead, Pull Up; Terrain Ahead, Pull Up"* or "Terrain, Terrain; Pull Up, Pull Up"
FLTA Obstacle Warning (ROC-W, IOI-W)	PULL UP	"Obstacle Ahead, Pull Up; Obstacle Ahead, Pull Up"* or "Obstacle, Obstacle; Pull Up, Pull Up"
FLTA Wire Warning (ILI-W, RLC-W)	PULL UP	"Wire Ahead Pull Up, Wire Ahead Pull Up"
FLTA Terrain Caution (RTC-C, ITI-C)	TERRAIN	"Terrain Ahead; Terrain Ahead"* or "Caution, Terrain; Caution, Terrain"
FLTA Obstacle Caution (ROC-C, IOI-C)	OBSTCL	"Obstacle Ahead; Obstacle Ahead"* or "Caution, Obstacle; Caution, Obstacle"
FLTA Wire Caution (ILI-C, RLC-C)	WIRE	"Wire Ahead"
Premature Descent Alert Caution (PDA)	TERRAIN	"Too Low, Terrain"
Excessive Descent Rate Caution (EDR-C)	TERRAIN	"Sink Rate"
Negative Climb Rate Caution (NCR-C)	TERRAIN	"Don't Sink"* or "Too Low, Terrain"
Voice Call Out (VCO-500)	None	"Five-Hundred"

* Alerts with multiple messages are configurable at installation and are installation-dependent. Alerts for the default configuration are indicated with asterisks.

Table 11-14 TAWS-B Alerts Summary

11.6.6.2 Excessive Descent Rate Alert

The purpose of the **Excessive Descent Rate (EDR)** alert is to provide notification when the aircraft is determined to be descending upon terrain at an excessive rate. The parameters for the alert as defined by TSO-C151c are shown below.

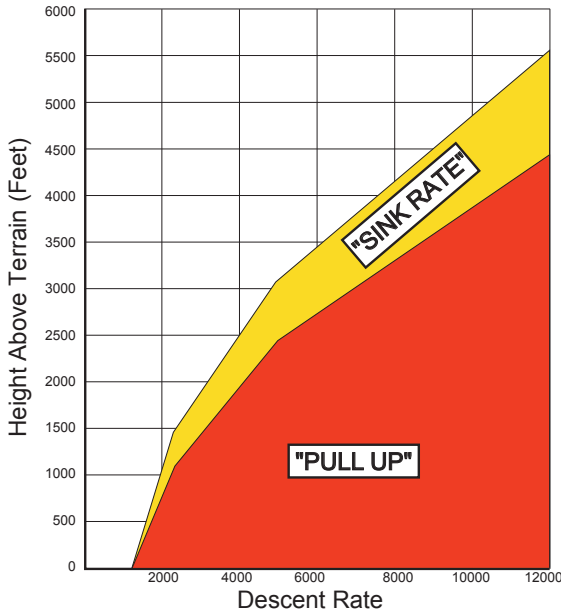

Figure 11-19 Excessive Descent Rate Alert Criteria

11.6.6.3 Forward Looking Terrain Avoidance

Reduced Required Terrain Clearance (RTC), Reduced Required Line Clearance (RLC), and Reduced Required Obstacle Clearance (ROC) alerts are issued when the aircraft flight path is above terrain, yet is projected to come within the minimum clearance values in the FLTA Alert Minimum Terrain and Obstacle Clearance Values table. When an RTC, RLC, and/or a ROC alert is issued, a threat location indicator is displayed on the TAWS Page.

Imminent Terrain Impact (ITI), Imminent Line Impact (ILI), and Imminent Obstacle Impact (IOI) alerts are issued when the aircraft is below the elevation of a terrain or obstacle cell in the aircraft's projected path. ITI, ILI, and IOI alerts are accompanied by a threat location indicator displayed on the TAWS Page. The alert is annunciated when the projected vertical flight path is calculated to come within minimum clearance altitudes in the following table.

Foreword	Flight Phase	Minimum Clearance Altitude (feet)	
		Level Flight	Descending
Getting Started	En Route	700	500
Audio & Xpdr Ctrl	Terminal	350	300
Com/Nav	Approach	150	100
	Departure	100	100

Table 11-15 FLTA Alert Minimum Terrain and Obstacle Clearance Values

During final approach, FLTA alerts are automatically inhibited when the aircraft is below 200 feet AGL while within 0.5 NM of the approach runway or below 125 feet AGL while within 1.0 NM of the runway threshold.

11.6.6.4 Premature Descent Alerting

A Premature Descent Alert (PDA) is issued when the system detects that the aircraft is significantly below the normal approach path to a runway.

PDA alerting begins when the aircraft is within 15 NM of the destination airport and ends when the aircraft is either 0.5 NM from the runway threshold or is at an altitude of 125 feet AGL while within 1.0 NM of the threshold. During the final descent, algorithms set a threshold for alerting based on speed, distance, and other parameters.

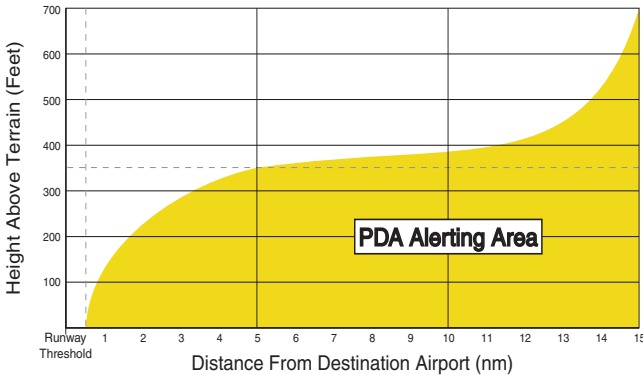

Figure 11-20 PDA Alerting Threshold

PDA and FLTA aural and visual alerts can be manually inhibited. Discretion should be used when inhibiting TAWS and the system should be enabled when appropriate. When TAWS is inhibited, the alert annunciation “TER INHB” is shown.

Foreword
Getting Started
Audio & Xpdr Ctrl
Com/Nav
FPL
Direct-To
Proc
Charts
Wpt Info
Map
Traffic
Terrain
Weather
Nearest
Services/Music
Utilities
System
Messages
Symbols
Appendix
Index

11.6.6.5 Inhibiting/Enabling TAWS-B PDA/FLTA Alerting

TAWS also has an inhibit mode that deactivates the PDA/FLTA aural and visual alerts. Pilots should use discretion when inhibiting TAWS and always remember to enable the system when appropriate. Only the PDA and FLTA alerts are disabled in the inhibit mode. After cycling power, TAWS will no longer be inhibited.

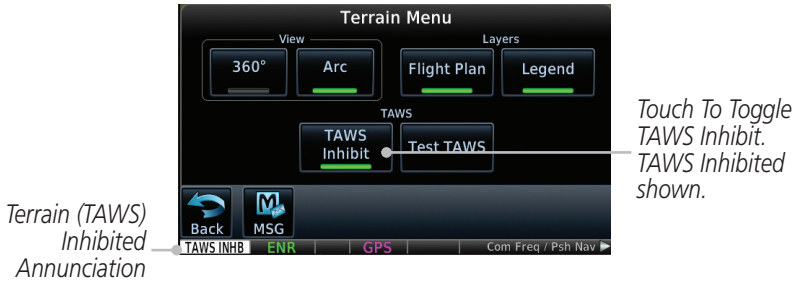

Figure 11-21 TAWS-B Alerting Disabled (TAWS Inhibited) Annunciation



1. While viewing the Terrain page, touch the **Menu** key.



2. Touch the **TAWS Inhibit** key to inhibit or enable TAWS (choice dependent on current state). A green bar in the key indicates the TAWS is inhibited.

11.6.6.6 Negative Climb Rate After Take-Off Alert (NCR)

The **Negative Climb Rate (NCR) After Take-Off** alert (also referred to as “Altitude Loss After Take-Off”) provides alerts when the system determines the aircraft is losing altitude (closing upon terrain) after takeoff. The aural message “Don’t Sink” is given for NCR alerts, accompanied by an annunciation and a pop-up terrain alert on the display. NCR alerting is only active when departing from an airport and when the following conditions are met:

- Height above the terrain is less than 700 feet
- Distance from the departure airport is 2 NM or less
- Heading change from the departure heading is less than 110°

The NCR alerting parameters as defined by TSO-C151c are shown below.

- Foreword
- Getting Started
- Audio & Xpdr Ctrl
- Com/Nav
- FPL
- Direct-To
- Proc
- Charts
- Wpt Info
- Map
- Terrain
- Weather
- Nearest
- Services/ Music
- Utilities
- System
- Messages
- Symbols
- Appendix
- Index

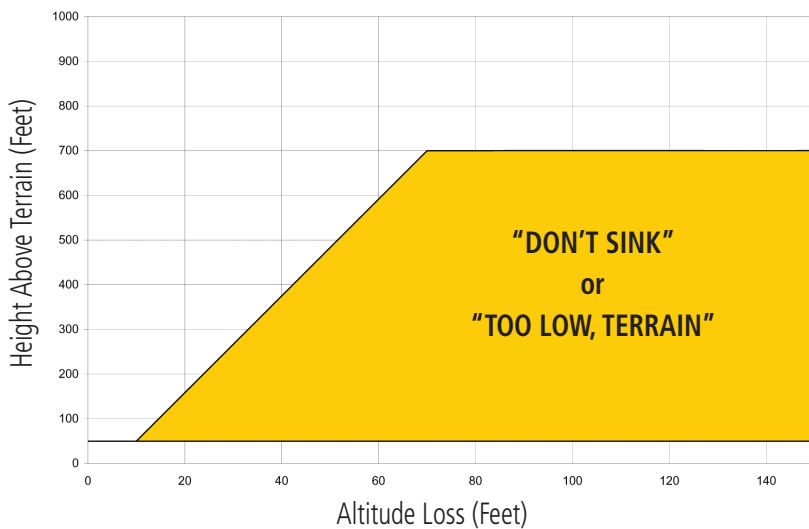

Figure 11-22 Negative Climb Rate (NCR) Altitude Loss

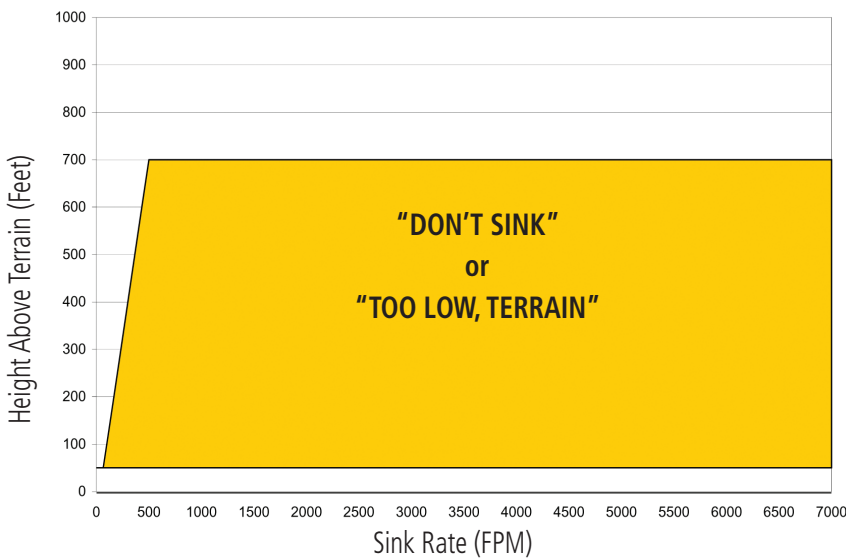

Figure 11-23 Negative Climb Rate (NCR) Sink Rate

11.6.6.7 Altitude Voice Call Out (VCO)

TAWS-B provides aural advisory alerts as the aircraft descends, beginning at 500 feet above the terrain, as determined by the radar altimeter (if greater than 5 NM from the nearest airport) or 500 feet above the nearest runway threshold elevation (if less than 5 NM from the nearest airport). Upon descent to this altitude, TAWS-B issues the aural alert message “Five-hundred.”

11.6.6.8 TAWS-B Not Available Alert

TAWS-B requires a 3-D GPS position solution along with specific vertical accuracy minimums. Should the position solution become degraded or if the aircraft is out of the database coverage area, the annunciation “TAWS N/A” is generated in the annunciation window and on the TAWS-B page. The aural message “TAWS Not Available” is generated. When the GPS signal is re-established and the aircraft is within the database coverage area, the aural message “TAWS Available” is generated (when the aircraft is airborne).

11.6.6.9 TAWS-B Failure Alert

TAWS-B continually monitors several system-critical items such as database validity, hardware status, and GPS status. If the terrain/obstacle database is not available, the aural message “TAWS System Failure” is generated along with a “TAWS FAIL” annunciation.

11.6.7 TAWS-B System Status

During power-up, TAWS-B conducts a self-test of its aural and visual annunciations. The system test can also be manually initiated. An aural alert is issued at test completion. TAWS System Testing is disabled when ground speed exceeds 30 knots.

Alert Type	Alert Annunciation	Aural Message
TAWS Available	None	“TAWS Available”
TAWS System Test in Progress	TAWS TEST	None
TAWS System Test Pass	None	“TAWS System Test OK”
TAWS N/A	TAWS N/A	TAWS Not Available
TAWS Alerting is Disabled	TAWS INHB	None
TAWS System Test Fail	TAWS FAIL	“TAWS System Failure”

Table 11-16 TAWS-B System Test Status Annunciations

11.7 HTAWS (Optional)



NOTE: *TERRAIN, TAWS, HTAWS, or HTERRAIN PROXIMITY functionality will be available via the Terrain page, depending on the installed hardware and configuration. HTAWS or HTERRAIN PROXIMITY are available in software v4.00, or later.*

Garmin's Helicopter Terrain Awareness Warning System (HTAWS) is an optional feature to increase situational awareness and aid in reducing controlled flight into terrain. Garmin HTAWS is TSO-C194 authorized. Units installed in helicopters that do not have HTAWS installed will display HTerrain Proximity. This is noted by the five color terrain scale which is appropriate to the low altitude operating environment for helicopters.

HTAWS provides visual and aural annunciations when terrain and obstacles are a hazard to the aircraft.

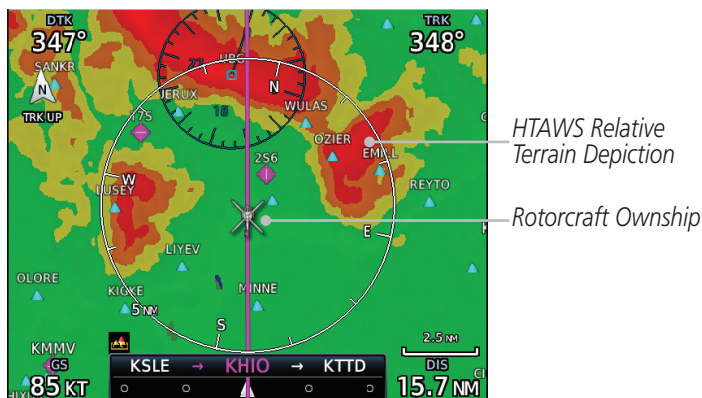

Figure 11-24 Map Page with Terrain



NOTE: *HTAWS-enabled units can be identified by going to the Terrain page and checking the lower right-corner for "HTAWS."*

11.7.1 HTAWS Requirements

- The system must have a valid 3D GPS position solution
- The system must have a valid terrain/obstacle database

11.7.2 HTAWS Limitations



NOTE: *The data contained in the terrain and obstacle databases comes from government agencies. Garmin accurately processes and cross-validates the data, but cannot guarantee its accuracy or completeness.*

HTAWS displays terrain and obstructions relative to the flight path of the aircraft. Individual obstructions may be shown if available in the database. However, all obstructions may not be available in the database and data may be inaccurate. Never use this information for navigation.



NOTE: *Terrain databases do not consistently represent foliage. Some trees may extend above HTAWS protection limits in some operating modes.*

Terrain information is based on terrain elevation data contained in a database that may contain inaccuracies. Terrain information should be used as an aid to situational awareness. Never use it for navigation or to maneuver to avoid terrain.

HTAWS uses terrain and obstacle information supplied by government sources. The data undergoes verification by Garmin to confirm accuracy of the content. However, the displayed information should never be understood as being all-inclusive.

11.7.3 Power Up

During power-up of the unit, the terrain/obstacle database versions are displayed along with a disclaimer to the pilot. At the same time, HTAWS self-test begins. HTAWS gives the following aural messages upon test completion:

- “**HTAWS System Test, OK,**” if the system passes the test
- “**HTAWS System Failure,**” if the system fails the test

A test failure is also annunciated visually for HTAWS, as shown in the HTAWS Alert Summary table.

11.7.4 HTAWS Page

HTAWS is shown on the Terrain page when HTAWS is available.

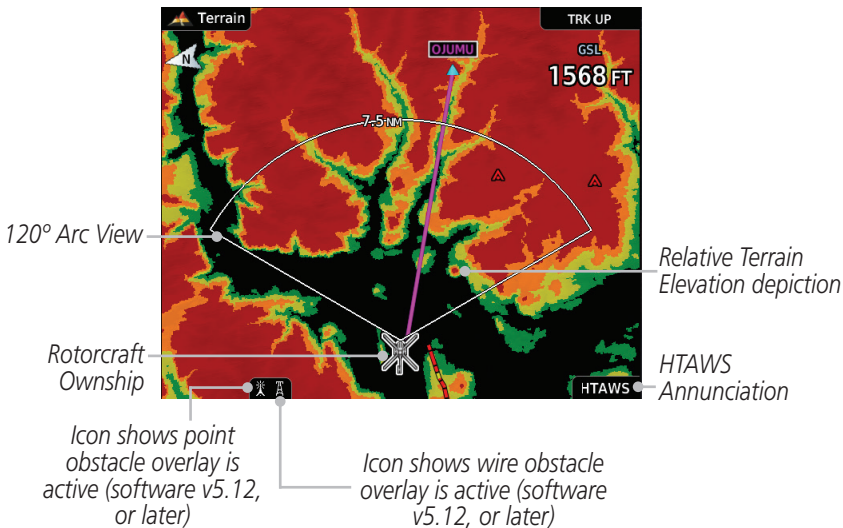

Figure 11-25 Terrain/HTAWS Page

Terrain information, aircraft ground track, and GPS-derived MSL altitude are displayed on the page. The “GSL” above altitude display in the top right corner of the display reminds the pilot that altitude is GPS-derived.

The HTAWS page menu provides options to acknowledge caution alerts, reduce protection, or inhibit alerting.



Figure 11-26 HTAWS Terrain Menu

- Foreword
- Getting Started
- Audio & Xpdr Ctrl
- Com/Nav
- FPL
- Direct-To
- Proc
- Charts
- Wpt Info
- Map
- Traffic
- Terrain**
- Weather
- Nearest
- Services/Music
- Utilities
- System
- Messages
- Symbols
- Appendix
- Index

11.7.4.1 View Selection

The HTAWS Page has two selectable view settings:



Figure 11-27 Terrain Page with HTAWS - 360° View

- 360° View—View from above aircraft depicting surrounding terrain on all sides.
- Arc (120°) View—View of terrain ahead of and 60° to either side of the aircraft flight path.



NOTE: If a heading source is available the HTAWS page will be oriented heading up. If no heading source is available the HTAWS page will be oriented track up.



1. While viewing the Terrain/HTAWS Page, touch **MENU**. Touch **Arc** or **360°**.



2. Touch **Back** to return to the Terrain/HTAWS display. The HTAWS Page displays the selected view. Repeat step 1 to select the alternate view, and touch **Back**.

11.7.4.2 HTAWS Inhibit

HTAWS provides an “inhibit mode.” This mode deactivates aural and visual alerts when they are deemed unnecessary by the aircrew. Pilots should use discretion when inhibiting the HTAWS system and always remember to enable the system when appropriate. VCO’s are not inhibited in Inhibit Mode. See section 11.5.5 for more information on HTAWS alerts. When alerting is inhibited, all FLTA aural and visual alerting is suppressed. HTAWS should only be inhibited when in visual contact with terrain and when the pilot can be assured of maintaining clearance from terrain and obstacles. When conducting en route operations and operations from published airports and heliports, HTAWS should be operated in Normal mode. HTAWS configured units will always start up with HTAWS alerts uninhibited.

To inhibit HTAWS alerts:



1. While viewing the Terrain/HTAWS page, touch **MENU**.



2. Touch **HTAWS Inhibit**. The green bar will show when HTAWS Inhibit is active.



3. Touch **Back** to return to the Terrain/HTAWS display. The HTAWS alerts are inhibited. The **HTAWS INHB** annunciation is displayed in the terrain annunciator field whenever HTAWS is inhibited.



NOTE: When the ground speed is less than 30 knots HTAWS will automatically display the “HTAWS INHB” annunciation. This indicates that HTAWS is no longer providing protection.

This automatic “TAWS INHB” cannot be removed by menu option selection. Menu selections for INHIBIT HTAWS and RP Mode remain available when HTAWS is automatically inhibited due to groundspeed. If the pilot selects a mode on the menu while HTAWS is auto inhibited because it is less than 30 knots then the unit will enter that mode once ground speed exceeds 30 knots. Hence, the presence of these selections on the Menu.

11.7.4.3 External HTAWS Inhibit Control

An optional installation is allowed for providing an external HTAWS Inhibit switch. Touching the external HTAWS Inhibit switch toggles the HTAWS inhibit on and off in the same manner as using the Terrain Menu selection.

11.7.4.4 Reduced Protection Mode

The Reduce Protection (RP) functionality allows operating with a reduction in the alerting thresholds, and suppresses visual and aural annunciation of caution alerts. Reduced protection allows low level operations and landings off airport with a minimum number of alerts while continuing to provide protection from terrain and obstacles. Reduced Protection should only be selected when operating in visual contact with the terrain as alerting times are significantly less than in normal mode. There is support for an external RP Mode switch and an external Alert Acknowledge switch.

To toggle protection:



1. While viewing the Terrain/HTAWS Page, touch **MENU**.



2. Touch the **RP Mode** key to toggle the RP mode on and off. The green bar will show when RP mode is active.



3. Touch **Back** to return to the Terrain/HTAWS display. The "RP Mode" annunciation is displayed in the terrain annunciator field and in the lower right corner of the terrain page whenever protection is reduced.

11.7.4.5 HTAWS Manual Test

Garmin HTAWS provides a manual test capability which verifies the proper operation of the aural and visual annunciations of the system prior to a flight.

To manually test the HTAWS system:



1. While viewing the Terrain/HTAWS page, touch **MENU**.



2. Touch the **Test HTAWS** key.



3. Touch **Back** to return to the Terrain/HTAWS display.

An aural message is played giving the test results:

- “**HTAWS System Test, OK**” if the system passes the test
- “**HTAWS System Failure**” if the system fails the test



NOTE: HTAWS System Testing is disabled when in the air so as not to impede HTAWS alerting.

11.7.4.6 HTAWS Legend



1. While viewing the Terrain/HTAWS page, touch **MENU**.



2. Touch the **Legend** key to toggle the legend on or off. The green bar will show when the Legend is active.



3. Touch **Back** to return to the Terrain/HTAWS display.



Figure 11-28 HTAWS Terrain and Obstacle Legend

Color	Description
Red	Terrain is more than 250 ft above the aircraft.
Orange	Terrain is between 0 ft and 250 ft above the aircraft.
Yellow	Terrain is between 250 ft and 0 ft below the aircraft.
Green	Terrain is between 250 ft and 500 ft below the aircraft.
Black	Terrain is more than 500 ft below the aircraft.

Table 11-17 HTAWS Terrain Altitude Color Description

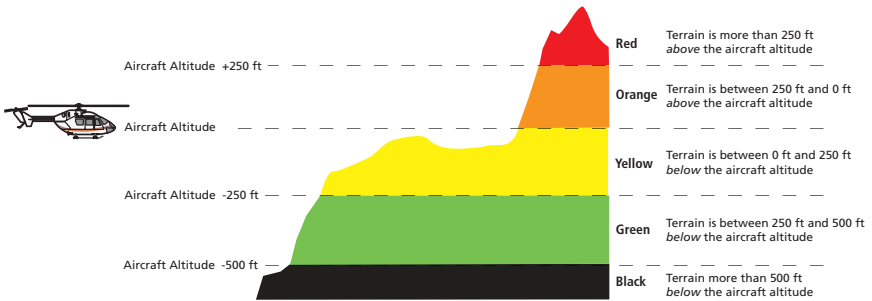

Figure 11-29 HTAWS Terrain Altitude Colors

11.7.4.7 Flight Plan Overlay



1. While viewing the Terrain/HTAWS page, touch **MENU**.
2. Touch the **Flight Plan** key to toggle the overlay of the active flight plan on or off. The green bar will show when the Flight Plan overlay is shown.
3. Touch **Back** to return to the Terrain/HTAWS display.

11.7.5 HTAWS Symbols

The symbols and colors in the following figures and table are used to represent obstacles and the location of terrain threats on the HTAWS Page. Each color is associated with a height above terrain.

Obstacles are ALWAYS shown on the TAWS page at 10 NM and below.



NOTE: *If an obstacle or terrain cell and the projected flight path of the aircraft intersect, the display automatically zooms in to the closest threat location on the HTAWS Page.*





	Tower	Windmill	Windmill in Group	Power Line
Proc				

Table 11-18 Obstacle Icon Types

Grouped obstacles are shown with an asterisk (as shown in the Windmill in Group example above). The color of the asterisks is tied to the relative altitude of the highest obstacle in the group, not other obstacles within that group. Obstacles are grouped when they would otherwise overlap.

- Foreword
- Getting Started
- Audio & Xpdr Ctrl
- Com/Nav
- FPL
- Direct-To
- Proc
- Charts
- Wpt Info
- Map
- Terrain
- Weather
- Nearest
- Services/Music
- Utilities
- System
- Messages
- Symbols
- Appendix
- Index













Obstacle Symbol	Unlighted Obstacle		Lighted Obstacle		Obstacle Color	Obstacle Location
	< 1000 ft AGL	> 1000 ft AGL	< 1000 ft AGL	> 1000 ft AGL		
					Red	Obstacle is at or above current aircraft altitude.
				Yellow	Obstacle is between 250 ft and 0 ft below current aircraft altitude.	
				White	Obstacle is 250 ft, or more, below current aircraft altitude. Obstacles are removed when more than 500 ft below the helicopter.	

Table 11-19 HTAWS Obstacle Colors and Symbology

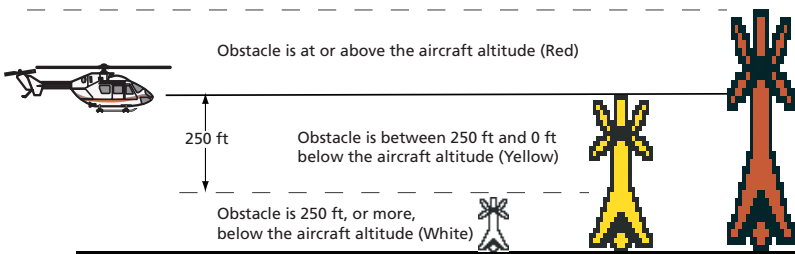

Figure 11-30 HTAWS Obstacle Altitude Colors and Symbology



Threat Location Indicator	Alert Level
	WARNING (Red)
	CAUTION (Yellow)

Table 11-20 HTAWS Alert Coloring and Symbology

11.7.6 HTAWS Alerts

Alerts are issued when flight conditions meet parameters that are set within HTAWS software algorithms. HTAWS alerts employ either a CAUTION or a WARNING alert severity level. When an alert is issued, visual annunciations are displayed. Aural alerts are simultaneously issued. Annunciations appear in a dedicated field in the lower left corner of the display.

Annunciations are color-coded according to the HTAWS Alert Summary table. Pop-up terrain alerts occur if an HTAWS alert is activated while not on the HTAWS page. There are two options when an alert is active.

To acknowledge the pop-up alert and return to the currently viewed page:

Touch the **Close** key.

To acknowledge the pop-up alert and quickly access the HTAWS Page:

Touch the **ENT** key.



NOTE: To further capture the attention of the pilot, HTAWS issues aural (voice) messages that accompany visual annunciations and pop-up alerts. For a summary of aural messages, see the HTAWS Alert Summary table.



NOTE: HTAWS Caution Alerts are displayed as constant black text on a yellow background; HTAWS Warning Alerts are displayed as constant white text on a red background.

11.7.6.1 Forward Looking Terrain Avoidance

The unit will issue terrain alerts not only when the aircraft altitude is below the terrain elevation but also when the aircraft is projected to come within minimum clearance values of the terrain. This alerting, called Forward Looking Terrain Avoidance (FLTA), is also provided for obstacles.

The FLTA functionality looks ahead of the aircraft using GPS position information and the terrain and obstacle databases to provide alerts when the predicted flight path does not clear the terrain or obstacle by the required clearance. The amount of clearance required varies depending on position relative to airports and heliports, in order to reduce the occurrence of nuisance alerting.

Any threat locations are depicted on the display. There are 2 levels of severity for FLTA alerts. They are cautionary (amber) and warning (red) in nature and are described in further detail below.

FLTA CAUTION—Estimated potential impact in approximately 30 seconds after a caution pop-up alert and annunciation. FLTA caution alerts are accompanied by the aural message “*Caution Terrain; Caution Terrain.*” Similarly, a “*Caution Obstacle; Caution Obstacle*” alert is also provided. The time to an alert can vary with conditions, therefore there is no guarantee of a 30 second caution alert being issued.

FLTA WARNING— Warning pop-up alerts are issued 15 seconds prior to an estimated potential impact in normal mode and approximately 10 seconds in RP Mode. FLTA warning alerts are accompanied by the aural message “*Warning - Terrain, Terrain.*” Similarly, a “*Warning - Obstacle, Obstacle*” alert is also provided. The time to an alert can vary with conditions, therefore there is no guarantee of a 15/10 second warning alert being issued.

The alerts are annunciated visually through the annunciator status bar, a pop-up alert box, and the red and yellow areas on the HTAWS page. The alerts are annunciated aurally through a voice message indicating the potential threat, such as “Caution - Terrain, Terrain” or “Warning - Obstacle, Obstacle.”

11.7.6.2 HTAWS Voice Call Out Aural Alert

The purpose of the Voice Call Out (VCO) aural alert messages are to provide an advisory alert to the pilot that the aircraft is between 500 feet and 100 feet above terrain in 100 foot increments. When the aircraft descends within the selected distance from the terrain, the aural message for the selected height above terrain is generated. There are no display annunciations or pop-up alerts that accompany the aural message. HTAWS allows an additional 50 foot VCO alert with radar altimeter input.

- Foreword
- Getting Started
- Audio & Xpdr Ctrl
- Com/Nav
- FPL
- Direct-To
- Proc
- Charts
- Wpt Info
- Map
- Traffic
- Terrain**
- Weather
- Nearest
- Services/ Music
- Utilities
- System
- Messages
- Symbols
- Appendix

11.7.6.3 HTAWS Voice Call Out Selection

The Voice Call Out (VCO) selection is available when HTAWS is installed. The VCO functionality provides a voice annunciation of the aircraft's height above terrain or the nearest airport, heliport, runway, or helipad when that threshold is first crossed. The available call outs include "Five Hundred" through "One Hundred" in one hundred foot intervals. The voice call outs can be enabled and disabled through the Voice Call Outs Selection option on the System - Audio page.



NOTE: VCOs are available down to 100 feet above terrain when HTAWS is installed and use GSL above terrain to generate call outs (no radar altimeter required). If a radar altimeter is interfaced to the GTN, alerts are available down to 50 feet and the height above terrain when the radar altimeter is used to generate the callouts.

To select the Voice Call Out choices in the System - Audio page, select the Voice Call Out Selection item and then select the desired value.

1. From the Main page, touch **System** and then **Audio**.



2. Touch the **Voice Callouts** key to view the Voice Call Outs page.

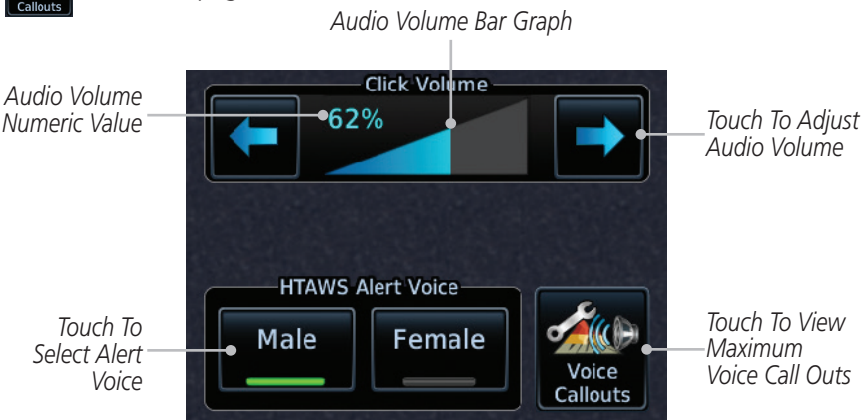

Figure 11-31 Select Voice Call Outs from the System Audio Page

MAX Voice Callout
None

3. Touch the **MAX Voice Callout** key to select the Voice Call Outs.

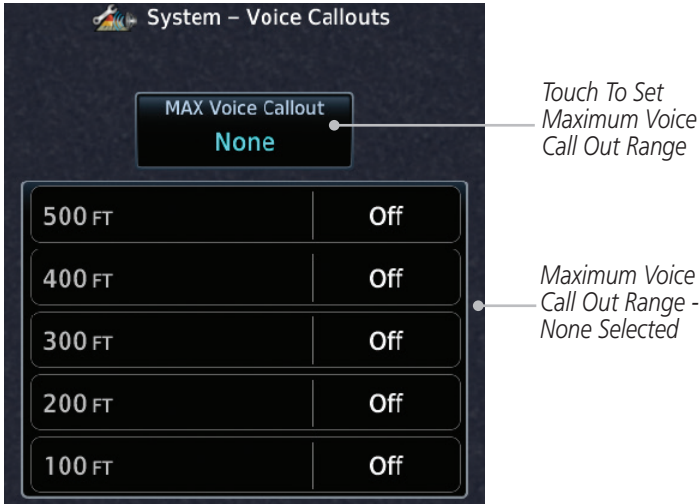

Figure 11-32 View the Maximum Voice Call Out Range (None Selected)

4. The values above the selected value will be disabled (Off).

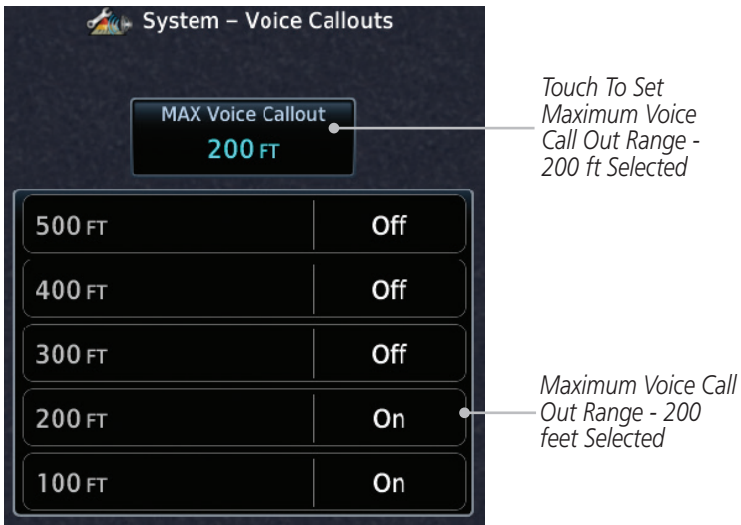

Figure 11-33 View the Maximum Voice Call Out Range (200 ft Selected)

11.7.6.4 HTAWS Not Available Alert

Garmin HTAWS requires a 3-D GPS navigation solution along with specific vertical accuracy minimums. Should the navigation solution become degraded, or if the aircraft is out of the database coverage area, the annunciation “HTAWS N/A” is shown in the annunciation window. When the GPS signal is re-established and the aircraft is within the database coverage area, the “HTAWS N/A” annunciation is removed.

11.7.6.5 HTAWS Failure Alert

HTAWS continually monitors several system-critical items, such as database validity, hardware status, and GPS status. If the terrain/obstacle database is not available, the aural message “HTAWS System Failure” is issued along with the “HTAWS FAIL” annunciation.

11.7.6.6 HTAWS Alert Summary

The aural alert voice gender is configurable to be either male or female. See your Garmin installer for further information on configuring the alert system.

HTAWS Annunciation	Pop-Up Alert	Aural Message	Description
HTAWS FAIL	None	“HTAWS System Failure”	HTAWS has failed
HTAWS INHB	None	None	HTAWS has been inhibited by the crew, or the aircraft ground-speed is below 30 knots (automatic inhibiting).
HTAWS N/A	None	“HTAWS Not Available”	HTAWS not available.
TERRAIN	CAUTION - TERRAIN	“Caution - Terrain, Terrain”	Forward Looking Terrain Avoidance Caution for Terrain.
TERRAIN	WARNING - TERRAIN	“Warning - Terrain, Terrain”	Forward Looking Terrain Avoidance Warning for Terrain.

HTAWS Annunciation	Pop-Up Alert	Aural Message	Description
OBSTACLE	CAUTION – OBSTACLE	“Caution - Obstacle, Obstacle”	Forward Looking Terrain Avoidance Caution for Obstacle.
OBSTACLE	WARNING – OBSTACLE	“Warning - Obstacle, Obstacle”	Forward Looking Terrain Avoidance Warning for Obstacle.
RP MODE	None	None	Alerting thresholds are reduced. Visual and aural annunciation of caution alerts are suppressed.
WIRE	CAUTION – WIRE	“Wire Ahead”	Forward Looking Terrain Avoidance Caution for Wire.
WIRE	WARNING – WIRE	“Wire Ahead Pull Up, Wire Ahead Pull Up”	Forward Looking Terrain Avoidance Warning for Power Lines.
None	None	“Five Hundred” “Four Hundred” “Three Hundred” “Two Hundred” “One Hundred” “Fifty”	HTAWS provides optional 500 ft through 100 ft (in 100 ft increments) altitude call out alerts. An additional value of 50 ft is available if a radar altimeter is installed.

Table 11-21 HTAWS Alert Summary



NOTE: HTAWS Caution Alerts are displayed as constant black text on a yellow background; HTAWS Warning Alerts are displayed as constant white text on a red background.

11.7.7 Pilot Actions

If an HTAWS warning and associated aural are received, the pilot should immediately maneuver the rotorcraft in response to the alert unless the terrain or obstacle is clearly identified visually and determined by the pilot not to be a factor to the safety of the operation.

A HTAWS caution alert indicates terrain or obstacle nearby. If possible visually locate the terrain or obstacle for avoidance. A HTAWS warning alert may follow a HTAWS caution unless the aircraft's path towards the terrain or obstacle is changed.



NOTE: *Display of terrain and obstacles on the display is supplemental data only. Maneuvering solely by reference to the terrain and obstacle data is not recommended or authorized.*

11.8 TAWS-A (Optional)



NOTE: *TERRAIN, TAWS-A, TAWS-B, HTAWS, or HTERRAIN PROXIMITY functionality will be available via the Terrain page, depending on the installed hardware and configuration. HTAWS or HTERRAIN PROXIMITY are available in software v4.00, or later. TAWS-A is available in software v5.00, or later.*



NOTE: *The data contained in the TAWS databases comes from government agencies. Garmin accurately processes and cross-validates the data but cannot guarantee its accuracy or completeness.*

TAWS-A (Terrain Awareness and Warning System - Class A) is an optional feature to increase situational awareness and aid in reducing controlled flight into terrain (CFIT). TAWS-A provides visual and aural annunciations when terrain and obstacles are within the given altitude threshold from the aircraft.

TAWS-A satisfies TSO-C151c Class A and TSO-92c requirements for certification.

11.8.1 TAWS-A Requirements

- A valid terrain/obstacle/airport terrain database
- A valid 3-D GPS position solution
- Valid flap and landing gear status inputs
- A valid radar altimeter

11.8.2 TAWS-A Limitations

TAWS-A uses terrain and obstacle information supplied by government sources. Terrain information is based on terrain elevation information in a database that may contain inaccuracies. Individual obstructions may be shown if available in the database. The data undergoes verification by Garmin to confirm accuracy of the content, per TSO-C151c. However, the displayed information should never be understood as being all-inclusive and data may be inaccurate.

Class A TAWS incorporates radar altimeter input with the GSL altitude to provide a more accurate position reference when at lower altitudes for certain alert types, and to retain a level of ground proximity warning capability in the unlikely event of an airport, terrain or obstacle database failure.

11.8.3 Displaying TAWS-A Data

TAWS-A uses yellow (caution) and red (warning) to depict terrain and obstacle (with a height greater than 200 feet above ground level, AGL) alerts relative to aircraft altitude. Depictions of obstacles more than 200 feet below the aircraft are removed. Colors are adjusted automatically as the aircraft altitude changes. The colors and symbols in Figure 11-28 and Tables 11-11 and 11-12 are used to represent terrain, obstacles, and threat locations.

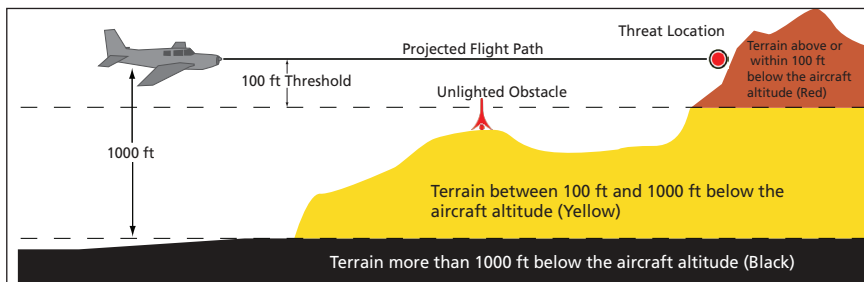

Figure 11-34 Terrain Altitude/Color Correlation for TAWS-A





Alert Level	Annunciator Text	Threat Location Indicator	Example Visual Annunciation
Warning	White text on red background		
Caution	Black text on yellow background		
Informational	Black text on white background	Not Applicable	

Table 11-22 TAWS-A Alert Colors and Symbology





Tower	Windmill	Windmill in Group	Power Line
			

Table 11-23 Obstacle Icon Types

Grouped obstacles are shown with an asterisk (as shown in the Windmill in Group example above). The color of the asterisks is tied to the relative altitude of the highest obstacle in the group, not other obstacles within that group. Obstacles are grouped when they would otherwise overlap.

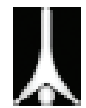







Obstacle Symbol	Unlighted Obstacle		Lighted Obstacle		Threat Location Indicator	Terrain Color	Terrain/Obstacle Location	Alert Level
	< 1000 ft AGL	> 1000 ft AGL	< 1000 ft AGL	> 1000 ft AGL				
								
					Yellow	Terrain/Obstacle between 100 ft and 1000 ft below current aircraft altitude	CAUTION (Yellow)	

Table 11-24 TAWS-A Terrain/Obstacle Colors and Symbology

11.8.4 TAWS-A Page

The TAWS-A page shows terrain, obstacle, and threat location data in relation to the aircraft's current altitude, without clutter from the basemap. Aviation data (airports, VORs, and other NAVAIDs) can be displayed for reference. If an obstacle and the projected flight path of the aircraft intersect, the display automatically zooms in to the closest potential point of impact on the TAWS-A page.

Aircraft orientation on this map is always heading up unless there is no valid heading. Two views are available relative to the position of the aircraft: the 360° default display and the radar-like ARC (120°) display. Map range is adjustable with the **In** and **Out** keys from 1 to 200 NM, as indicated by the map range rings (or arcs).

Terrain Page Title

Track Annunciation

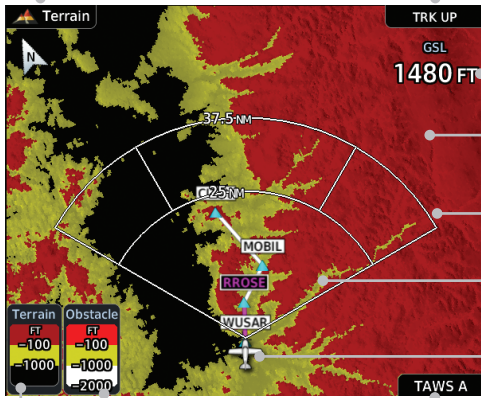

Aircraft GSL Value (GPS Derived)

Red Terrain Is Above Or Within 100 ft Below The Aircraft Altitude

Range Arc

Yellow Terrain Is Between 100 ft and 1000 ft Below The Aircraft Altitude

Ownship Position

Terrain Legend

Obstacle Legend (software v6.00, or later)

Terrain Type

Figure 11-35 TAWS-A Page with Arc View

Terrain Page Title

Heading Annunciation



Aircraft GSL Value (GPS Derived)

Red Terrain Is Above Or Within 100 ft Below The Aircraft Altitude

Ownship Position

Yellow Terrain Is Between 100 ft and 1000 ft Below The Aircraft Altitude

TAWS Annunciations (all annunciations shown on Terrain page)

Lighted Tower Obstacle

An Asterisk Indicates Grouped Obstacles

Lighted Windmill Obstacle

TAWS Annunciations (shown on all displays) (+ indicates there are more annunciations and will show each one for five seconds)

Range Arcs

Terrain Type

Figure 11-36 TAWS-A Page with 360° View



1. While viewing the Terrain page, touch the **Menu** key.
2. Selections are grouped by function: View, Layers, and TAWS.

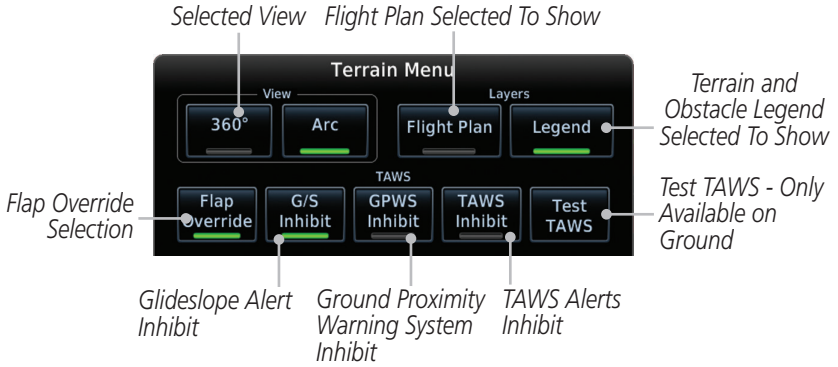

Figure 11-37 TAWS-A Menu

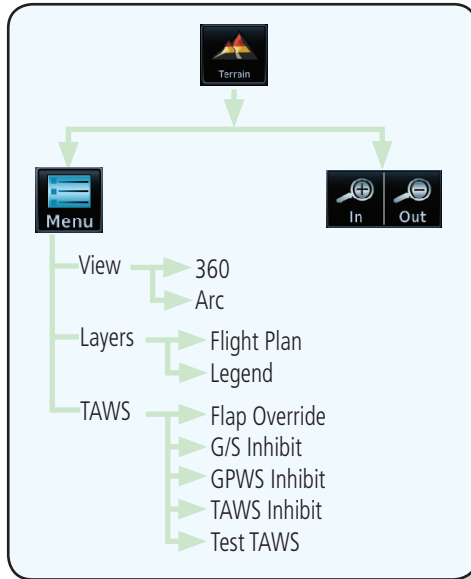

Figure 11-38 TAWS-A Page Functional Diagram

11.8.5 TAWS-A Alerts

Alerts are issued when flight conditions meet parameters that are set within TAWS-A software algorithms. TAWS-A alerts employ a CAUTION or a WARNING alert severity level. When an alert is issued, visual annunciations are displayed and aural alerts are simultaneously issued. TAWS-A alert types with corresponding annunciations and aural messages are shown in Table 11-13.

When an alert is issued, annunciations appear on the display. The TAWS-A Alert Annunciation is shown on the lower left part of the display. If the TAWS-A Page is not already displayed, a pop-up alert appears while an alert is active.

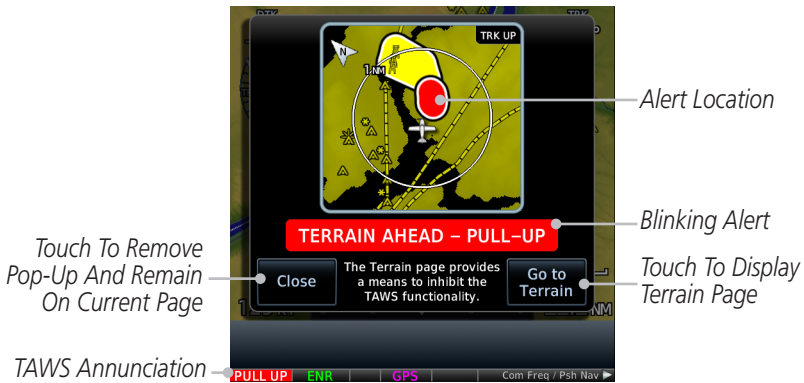

Figure 11-39 Terrain Alert Pop-Up

To acknowledge the pop-up alert:

Close

Touch the **Close** key (returns to the currently viewed page), or

Go to Terrain

Touch the **Go to Terrain** key (accesses the TAWS-A Page)

11.8.5.1 TAWS-A Alert Types

TAWS-A provides the following alert types:

- Forward Looking Terrain Avoidance (FLTA) Alerting, which consists of:
 - Required Terrain Clearance (RTC) / Required Line Clearance (RLC) / Required Obstacle Clearance (ROC) Alerting
 - Imminent Terrain Impact (ITI) / Imminent Line Impact (ILI) / Imminent Obstacle Impact (IOI) Alerting

- Premature Descent Alerting (PDA)
- Ground Proximity Warning System (GPWS) Alerting, which consists of:
 - Excessive Descent Rate (EDR) Alerting
 - Excessive Closure Rate (ECR) to Terrain Alerting
 - Flight Into Terrain (FIT) Alerting
 - Negative Climb Rate (NCR) after takeoff Alerting
 - Excessive below Glideslope/Glidepath Deviation (GSD) Alerting
 - Altitude Voice Call Out (VCO) Alerting

11.8.5.2 TAWS-A Alerts Summary

Alert Type	Alert Annunciation	Pop-Up Alert (Except TAWS-A Page)	Aural Message
Reduced Required Terrain Clearance Warning (RTC)	PULL UP	TERRAIN – PULL-UP * or TERRAIN AHEAD – PULL-UP	“Terrain, Terrain; Pull Up, Pull Up” * or “Terrain Ahead, Pull Up; Terrain Ahead, Pull Up”
Imminent Terrain Impact Warning (ITI)	PULL UP	TERRAIN – PULL-UP * or TERRAIN AHEAD – PULL-UP	“Terrain, Terrain; Pull Up, Pull Up” * or “Terrain Ahead, Pull Up; Terrain Ahead, Pull Up”
Reduced Required Obstacle Clearance Warning (ROC)	PULL UP	OBSTACLE – PULL-UP * or OBSTACLE AHEAD – PULL-UP	“Obstacle, Obstacle; Pull Up, Pull Up” * or “Obstacle Ahead, Pull Up; Obstacle Ahead, Pull Up”
Imminent Obstacle Impact Warning (IOI)	PULL UP	OBSTACLE – PULL-UP * or OBSTACLE AHEAD – PULL-UP	“Obstacle, Obstacle; Pull Up, Pull Up” * or “Obstacle Ahead, Pull Up; Obstacle Ahead, Pull Up”

Foreword

Getting Started

Audio & Xpdr Ctrl

Com/Nav

FPL

Direct-To

Proc

Charts

Wpt Info

Map

Traffic

Terrain

Weather

Nearest

Services/
Music

Utilities

System

Messages

Symbols

Appendix

	Alert Type	Alert Annunciation	Pop-Up Alert (Except TAWS-A Page)	Aural Message
	Excessive Descent Rate Warning (EDR)	PULL UP	PULL-UP	"<whoop> <whoop> Pull Up"
	Excessive Closure Rate Warning (ECR)	PULL UP	PULL-UP	"<whoop> <whoop> Pull Up"
	Imminent Line Impact Warning (ILI)	PULL UP	WIRE AHEAD – PULL-UP	"Wire Ahead, Pull Up; Wire Ahead, Pull Up" or "Wire, Wire; Pull Up, Pull Up"
	Reduced Line Clearance Warning (RLC)	PULL UP	WIRE AHEAD – PULL-UP	"Wire Ahead, Pull Up; Wire Ahead, Pull Up" or "Wire, Wire; Pull Up, Pull Up"
	Reduced Required Terrain Clearance Caution (RTC)	TERRAIN	CAUTION – TERRAIN * or TERRAIN AHEAD	"Caution, Terrain; Caution, Terrain" * or "Terrain Ahead; Terrain Ahead"
	Imminent Terrain Impact Caution (ITI)	TERRAIN	CAUTION – TERRAIN * or TERRAIN AHEAD	"Caution, Terrain; Caution, Terrain" or "Terrain Ahead; Terrain Ahead"
	Reduced Required Obstacle Clearance Caution (ROC)	OBSTCL	CAUTION – OBSTACLE * or OBSTACLE AHEAD	"Caution, Obstacle; Caution, Obstacle" * or "Obstacle Ahead; Obstacle Ahead"
	Imminent Obstacle Impact Caution (IOI)	OBSTCL	CAUTION – OBSTACLE * or OBSTACLE AHEAD	"Obstacle Ahead; Obstacle Ahead" * or "Caution, Obstacle; Caution, Obstacle"

Alert Type	Alert Annunciation	Pop-Up Alert (Except TAWS-A Page)	Aural Message
Imminent Line Impact Caution (ILI)	WIRE	WIRE AHEAD	"Wire Ahead; Wire Ahead"* or "Caution, Wire; Caution, Wire"
Reduced Line Clearance Caution (RLC)	WIRE	WIRE AHEAD	"Wire Ahead; Wire Ahead"* or "Caution, Wire; Caution, Wire"
Premature Descent Alert Caution (PDA)	TERRAIN	TOO LOW - TERRAIN	"Too Low, Terrain"
Excessive Descent Rate Caution (EDR)	TERRAIN	SINK RATE	"Sink Rate"
Excessive Closure Rate Caution (ECR)	TERRAIN	TERRAIN	"Terrain, Terrain"
Negative Climb Rate Caution (NCR)	TERRAIN	DON'T SINK * or TOO LOW - TERRAIN	"Don't Sink"* or "Too Low, Terrain"
Flight Into Terrain High Speed Caution (FIT)	TERRAIN	TOO LOW - TERRAIN	"Too Low, Terrain"
Flight Into Terrain Gear Caution (FIT)	TERRAIN	TOO LOW - GEAR	"Too Low, Gear"
Flight Into Terrain Flaps Caution (FIT)	TERRAIN	TOO LOW - FLAPS	"Too Low, Flaps"
Flight Into Terrain Takeoff Caution (FIT)	TERRAIN	TOO LOW - TERRAIN	"Too Low, Terrain"
Glide Slope Deviation Caution (GSD)	GLIDESLOPE	GLIDESLOPE	"Glideslope"
Altitude Voice Call Out (VCO)	None	None	"Five-Hundred," "Four-Hundred,"* "Three-Hundred,"* "Two-Hundred,"* "One-Hundred"*
TAWS Available	None	N/A	"TAWS Available"

Foreword

Getting Started

Audio & Xpdr Ctrl

Com/Nav

FPL

Direct-To

Proc

Charts

Wpt Info

Map

Traffic

Terrain

Weather

Nearest

Services/Music

Utilities

System

Messages

Symbols

Appendix

Foreword
Getting Started
Audio & Xpdr Ctrl
Com/Nav
FPL
Direct-To
Proc
Charts
Wpt Info
Map
Traffic
Terrain
Weather
Nearest
Services/Music
Utilities
System
Messages
Symbols

Alert Type	Alert Annunciation	Pop-Up Alert (Except TAWS-A Page)	Aural Message
TAWS System Test in Progress	TAWS TEST	N/A	None
TAWS System Test Pass	None	N/A	"TAWS System Test OK"
TAWS N/A	TAWS N/A	N/A	TAWS Not Available
TAWS Alerting is Disabled	TAWS INHB	N/A	None
TAWS System Test Fail	TAWS FAIL	N/A	"TAWS System Failure"
Incorrect TAWS configuration, invalid/missing terrain, airport, or obstacle database, or TAWS audio fault.	TAWS FAIL **	N/A	"TAWS System Failure"
No GPS position	TAWS N/A	N/A	"TAWS Not Available"
GPS position unavailable/ degraded, outside of terrain database coverage	TAWS N/A	N/A	"TAWS Not Available"
Sufficient GPS signal reception restored	None	N/A	"TAWS Available" (aural message only in flight)
Incorrect TAWS configuration, radar altimeter unavailable, GPS position unavailable/ degraded, TAWS audio fault	GPWS FAIL *	N/A	"GPWS System Failure"
GPWS Inhibit	GPWS INHB	N/A	"GPWS System Failure"

Appendix

Alert Type	Alert Annunciation	Pop-Up Alert (Except TAWS-A Page)	Aural Message
GPWS Not Available. Incorrect TAWS configuration, radar altimeter unavailable, GPS position unavailable/degraded, TAWS audio fault.	GPWS N/A	N/A	None
Glideslope Inhibit	G/S INHB	N/A	None
FLAP Override	FLAP OVRD	N/A	None

* Alerts with multiple messages are configurable. Alerts for the default configuration are indicated with asterisks.

** VCO alerts are not issued if both TAWS and GPWS systems have failed or are not available

† GSD alert will be available if a valid ILS is being used for navigation, even in no valid GPS signal is being received.

Table 11-25 TAWS-A Alerts Summary

11.8.5.3 Excessive Descent Rate Alert

The purpose of the **Excessive Descent Rate (EDR)** alert is to provide notification when the aircraft is determined to be descending upon terrain at an excessive rate. The parameters for the alert as defined by TSO-C151c are shown below.

Foreword

Getting Started

Audio & Xpdr Ctrl

Com/Nav

FPL

Direct-To

Proc

Charts

Wpt Info

Map

Traffic

Terrain

Weather

Nearest

Services/ Music

Utilities

System

Messages

Symbols

Appendix

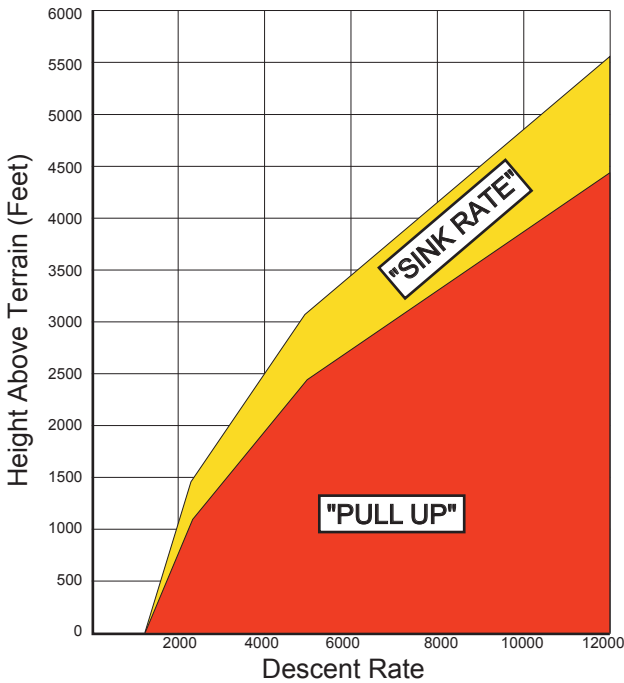

Figure 11-40 Excessive Descent Rate Alert Criteria

11.8.5.4 Forward Looking Terrain Avoidance

Reduced Required Terrain Clearance (RTC), Reduced Required Line Clearance (RLC), and Reduced Required Obstacle Clearance (ROC) alerts are issued when the aircraft flight path is above terrain, yet is projected to come within the minimum clearance values in the FLTA Alert Minimum Terrain and Obstacle Clearance Values table. When an RTC, RLC, and/or a ROC alert is issued, a threat location indicator is displayed on the TAWS Page.

Imminent Terrain Impact (ITI), Imminent Line Impact (ILI), and Imminent Obstacle Impact (IOI) alerts are issued when the aircraft is below the elevation of a terrain or obstacle cell in the aircraft's projected path. ITI, ILI, and IOI alerts are accompanied by a threat location indicator displayed on the TAWS Page. The alert is annunciated when the projected vertical flight path is calculated to come within minimum clearance altitudes in the following table.

Flight Phase	Minimum Clearance Altitude (feet)	
	Level Flight	Descending
En Route	700	500
Terminal	350	300
Approach	150	100
Departure	100	100

Table 11-26 FLTA Alert Minimum Terrain and Obstacle Clearance Values

During final approach, FLTA alerts are automatically inhibited when the aircraft is below 200 feet AGL while within 0.5 NM of the approach runway or below 125 feet AGL while within 1.0 NM of the runway threshold.

11.8.5.5 Premature Descent Alerting

A Premature Descent Alert (PDA) is issued when the system detects that the aircraft is significantly below the normal approach path to a runway.

PDA alerting begins when the aircraft is within 15 NM of the destination airport and ends when the aircraft is either 0.5 NM from the runway threshold or is at an altitude of 125 feet AGL while within 1.0 NM of the threshold. During the final descent, algorithms set a threshold for alerting based on speed, distance, and other parameters.

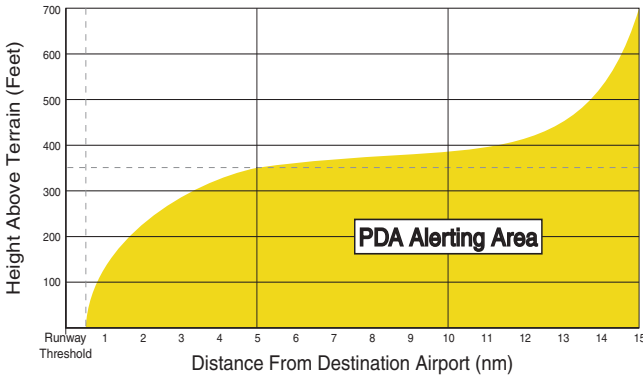

Figure 11-41 PDA Alerting Threshold

PDA and FLTA aural and visual alerts can be manually inhibited. Discretion should be used when inhibiting TAWS and the system should be enabled when appropriate. When TAWS is inhibited, the alert annunciation “TER INHB” is shown.

11.8.5.6 Inhibiting/Enabling TAWS-A PDA/FLTA Alerting

TAWS-A also has an inhibit mode that deactivates the PDA/FLTA aural and visual alerts. Pilots should use discretion when inhibiting TAWS-A and always remember to enable the system when appropriate. Only the PDA and FLTA alerts are disabled in the inhibit mode. After cycling power, TAWS-A will no longer be inhibited.

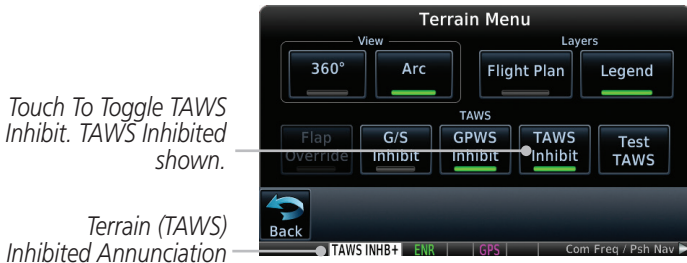

Figure 11-42 TAWS-A Alerting Disabled (TAWS Inhibited) Annunciation

1. While viewing the Terrain page, touch the **Menu** key.
2. Touch the **TAWS Inhibit** key to inhibit or enable TAWS (choice is dependent on current state). A green bar in the key indicates the TAWS is inhibited.



11.8.5.7 Excessive Closure Rate Alert

The **Excessive Closure Rate (ECR)** alert provides suitable notification when the aircraft is determined to be closing upon terrain at an excessive speed for a given aircraft gear and flap configuration.

The following figures show the ECR alerting criteria for flaps in the landing configuration and for all other flight phases respectively.

ECR alerts are automatically inhibited when the aircraft is 5 NM from the nearest airport, except when FLTA is not available (causing the TAWS N/A or TAWS FAIL annunciation to be displayed), in which case ECR alerting will remain active until landing.

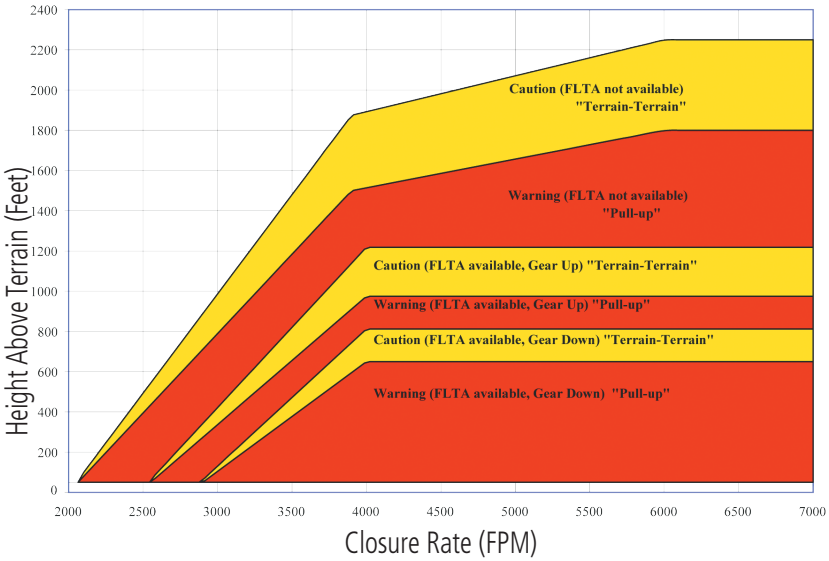

Figure 11-43 Excessive Closure Rate Alert Criteria (Flaps Up or Takeoff Configuration)

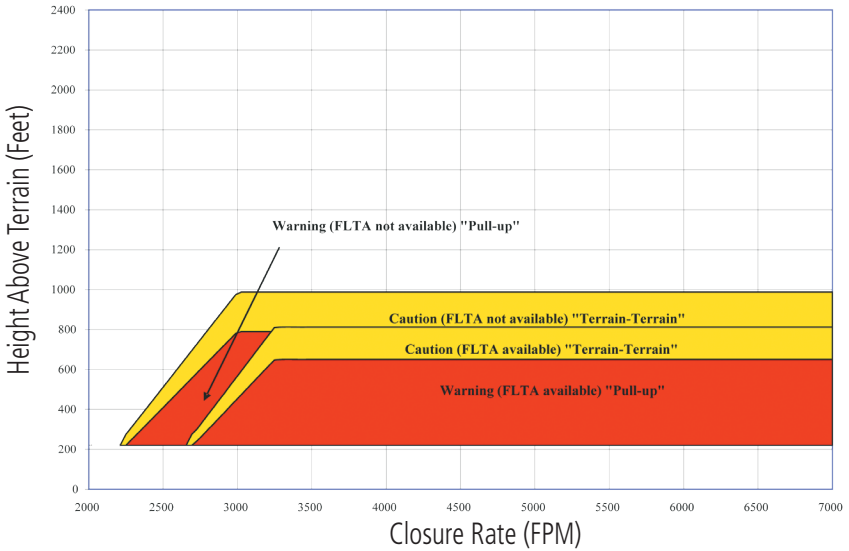
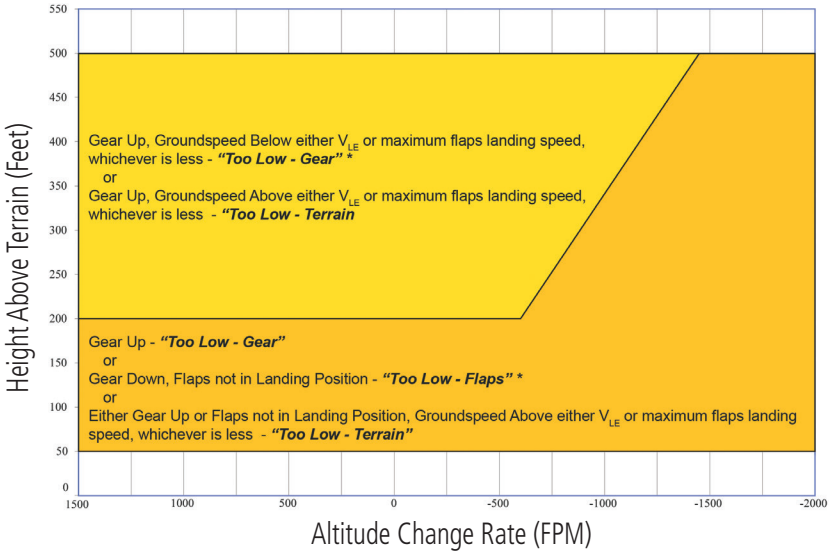

Figure 11-44 Excessive Closure Rate Alert Criteria (Flaps in Landing Configuration)

- Foreword
- Getting Started
- Audio & Xpdr Ctrl
- Com/Nav
- FPL
- Direct-To
- Proc
- Charts
- Wpt Info
- Map
- Terrain
- Traffic
- Weather
- Nearest
- Services/Music
- Utilities
- System
- Messages
- Symbols
- Appendix

11.8.5.8 Flight Into Terrain Alert

Flight Into Terrain (FIT) alerts occur when the aircraft is too low with respect to terrain based on landing gear status, flap position, and groundspeed. FIT caution alerts are issued when flight conditions meet the criteria shown below.



* Flap position will not trigger alert if Flap Override option is enabled; see discussion below.

Figure 11-45 Flight Into Terrain Caution Alert Criteria

To reduce nuisance FIT alerts on approaches where flap extension is not desired (or is intentionally delayed), the pilot may override FIT alerting based on the flap position, while all other FIT alerting remains in effect.



Figure 11-46 TAWS-A Page Menu and FIT Flap Override Annunciation

11.8.5.8.1 Overriding Flaps-based FIT alerting



1. While viewing the TAWS-A Page, touch the **MENU** key.



2. Touch the **Flap Override** key to toggle the override state.

When the Flaps Override option is enabled, the annunciation “FLAP O/R” is annunciated on the TAWS-A Page. If GPWS alerts are also inhibited (which include FIT), the “FLAP O/R” annunciation is not shown.



NOTE: *The FLAP O/R (Flap Override) should be activated when an approach without flaps is going to be performed.*

FIT alerts also occur during takeoff or go-around if the aircraft’s height above ground level (as determined by the radar altimeter) is too close to rising terrain. TAWS-A will issue the aural message “**Too Low - Terrain**” and visual annunciations when conditions enter the caution alert area.

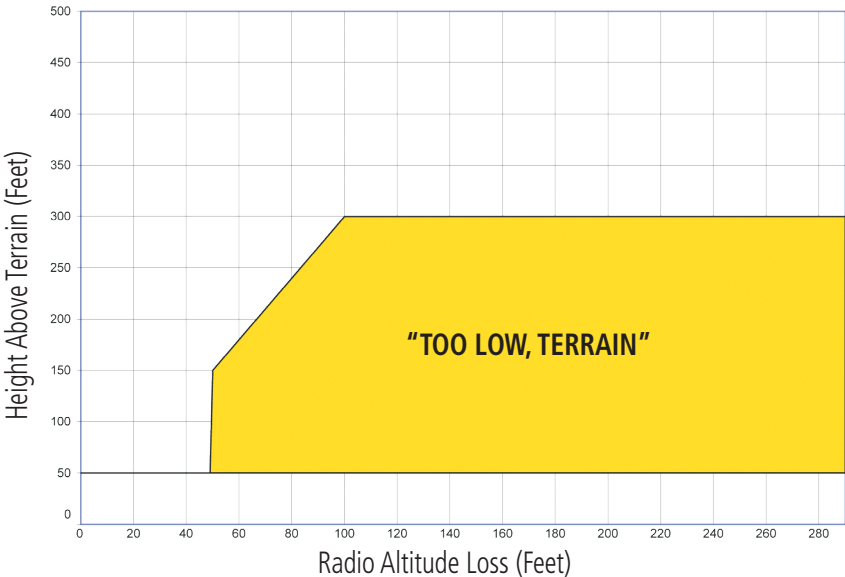

Figure 11-47 FIT Alerting After Takeoff

11.8.5.9 Negative Climb Rate After Take-Off Alert (NCR)

The **Negative Climb Rate (NCR) After Take-Off** alert (also referred to as “Altitude Loss After Take-Off”) provides alerts when the system determines the aircraft is losing altitude (closing upon terrain) after takeoff. The aural message “Don’t Sink” is given for NCR alerts, accompanied by an annunciation and a pop-up terrain alert on the display. NCR alerting is only active when departing from an airport and when the following conditions are met:

- Height above the terrain is less than 700 feet
- Distance from the departure airport is 2 NM or less
- Heading change from the departure heading is less than 110°

The NCR alerting parameters as defined by TSO-C151c are shown below.

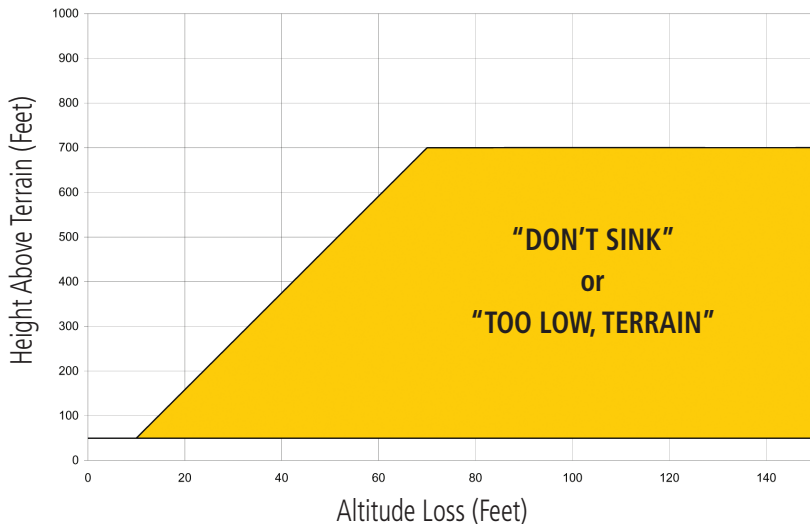

Figure 11-48 Negative Climb Rate (NCR) Altitude Loss

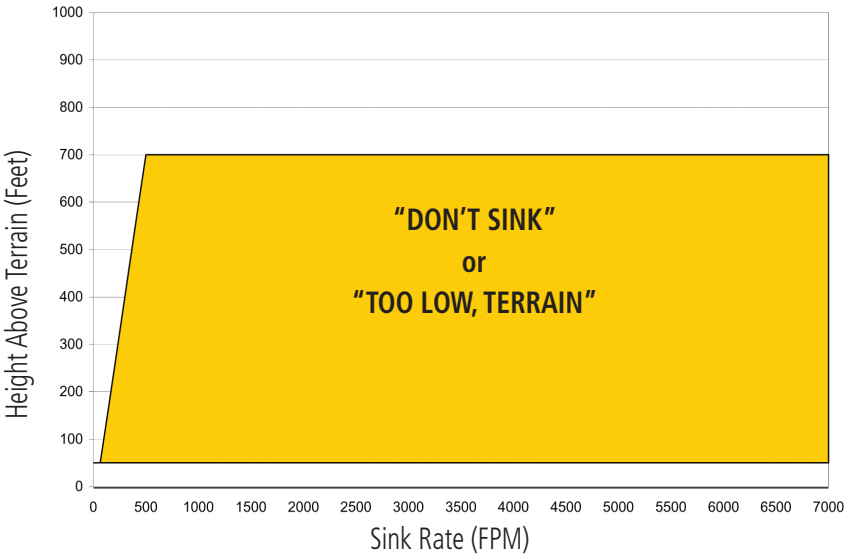

Figure 11-49 Negative Climb Rate (NCR) Sink Rate

11.8.5.10 Excessive Below Glideslope/Glidepath Deviation Alert

A **Glideslope Deviation** or **Glidepath Deviation (GSD)** caution alert is issued when the system detects that the aircraft is significantly below the glidepath for the selected approach.

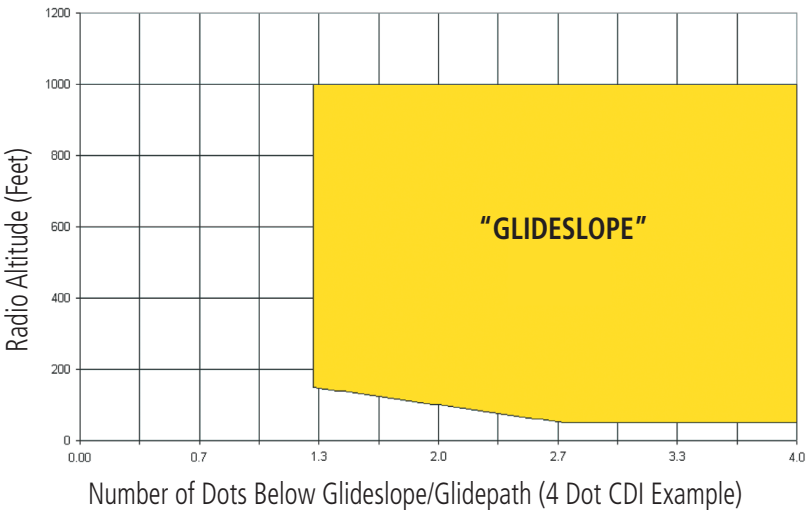

Figure 11-50 Excessive Below Glideslope/Glidepath Deviation Alert Criteria

- Foreword
- Getting Started
- Audio & Xpdr Ctrl
- Com/Nav
- FPL
- Direct-To
- Proc
- Charts
- Wpt Info
- Map
- Traffic
- Terrain**
- Weather
- Nearest
- Services/ Music
- Utilities
- System
- Messages
- Symbols
- Appendix

GSD alerting is only active after departure and the following conditions are met:

- An ILS, LPV, LNAV/VNAV, or LNAV+V approach is active and vertical navigation indications are being displayed.
- Aircraft is below 1000 feet AGL.
- Gear is configured for landing.

When a GSD caution alert occurs, the aural and visual annunciation “GLIDESLOPE” is issued. If a GSD caution alert occurs on an LPV, LNAV/VNAV, or LNAV+V approach, the aural and visual annunciation “GLIDESLOPE” is issued.

11.8.5.10.1 Inhibiting Glideslope Deviation (GSD) Alerts



NOTE: The Glideslope (G/S) Inhibit function should be activated when flying a localizer backcourse approach to prevent nuisance GSD alerts. GSD alerts are inhibited independent from all other FLTA, PDA, and GPWS alerts.



1. While viewing the TAWS-A Page, touch the **MENU** key.



2. Touch the **G/S Inhibit** key to inhibit or enable glideslope or glidepath alerts (choice dependent on current state).



NOTE: The G/S Inhibit function will only be active for a single approach and the inhibit function will not remain active for subsequent approaches. When G/S alerts are inhibited, they are only inhibited for a single approach. To inhibit G/S alerts on the next approach, the G/S Inhibit function must be activated again between the first and second approaches.



NOTE: Glideslope Deviation alerts will not be available if the G/S INHB function is activated.

11.8.5.11 Inhibiting GPWS Alerts (EDR, ECR, FIT, and NCR)



NOTE: The "Inhibit GPWS" function only affects GPWS alerts (EDR, ECR, NCR, and FIT). Alerting for FLTA, PDA, and GSD is controlled independently from the GPWS alerts listed below.

EDR, ECR, FIT, and NCR aural and visual alerts can be manually inhibited as a group. Discretion should be used when inhibiting alerts and the GPWS system should be enabled when appropriate. When these alerts are inhibited, the alert annunciation "GPWS INH" is shown on the TAWS-A Page annunciation window.



1. While viewing the TAWS-A Page, touch the **MENU** key.



2. Touch the **GPWS Inhibit** key to inhibit or enable GPWS alerts (choice dependent on current state).



Figure 11-51 GPWS Inhibit Annunciation

11.8.6 Altitude Voice Call Out (VCO)

TAWS-A provides aural advisory alerts as the aircraft descends, beginning at 500 feet above the terrain, as determined by the radar altimeter (if greater than 5 NM from the nearest airport) or 500 feet above the nearest runway threshold elevation (if less than 5 NM from the nearest airport). Upon descent to this altitude, TAWS-A issues the aural alert message "Five-hundred."

11.8.7 TAWS-A System Status

During power-up, TAWS-A conducts a self-test of its aural and visual annunciations. The system test can also be manually initiated. An aural alert is issued at test completion. TAWS-A System Testing is disabled when ground speed exceeds 30 knots.

11.8.8 TAWS-A Abnormal Operations

TAWS-A continually monitors several system-critical items such as database validity, flap and landing gear position, radar altimeter input, and GPS status.

If the GTN does not contain Terrain, Airport Terrain, and Obstacle databases (or the databases are invalid), the aural message “*TAWS System Failure*” is generated along with the “TAWS FAIL” alert annunciation.

TAWS-A requires a 3-D GPS navigation solution along with specific vertical accuracy minimums. Should the navigation solution become degraded or if the aircraft is out of the database coverage area, the annunciation “TAWS N/A” is generated in the annunciation window and on the TAWS-A page, the aural message “*TAWS Not Available*” is generated if airborne, some TAWS-A terrain alerts will not be issued, and GPWS alerting (which are not dependent on GPS position) will continue to operate. When the GPS signal is re-established and the aircraft is within the database coverage area, the aural message “TAWS Available” is generated.

TAWS-A also requires radar altimeter input. Should the radar altimeter input fail or become degraded, the annunciation “GPWS FAIL” is generated in the annunciation window and on the TAWS-A Page. The aural message “*GPWS System Failure*” is also generated. The “GPWS FAIL” annunciation will also occur if both GPS altitude and barometric altitude are unavailable. If only the GPWS system has failed, GPWS-based alerts will not be available, while other TAWS-A alerting remains unaffected.

Multiple TAWS or GPWS annunciations cannot be displayed at the same time. When multiple annunciations exist, an asterisk will be present next to the annunciation. The display of each annunciation will alternate with each being displayed for approximately five seconds.

- Foreword
- Getting Started
- Audio & Xpdr Ctrl
- Com/Nav
- FPL
- Direct-To
- Proc
- Charts
- Wpt Info
- Map
- Traffic
- Terrain**
- Weather
- Nearest
- Services/ Music
- Utilities
- System
- Messages
- Symbols
- Appendix

12 WEATHER

Weather data are displayed by the Weather function when an optional weather source is installed. The Wx Weather pages may be oriented to Track Up, Heading Up, or North Up.

When more weather products are installed, a key for each product will be shown. Touch the key for the desired weather product. When a single weather product is installed, touching the **Weather** key will go directly to the Weather page.

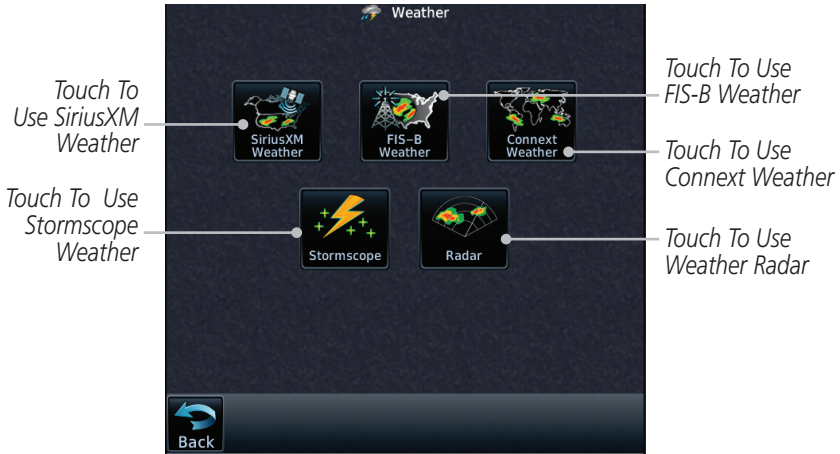

Figure 12-1 Weather Product Selection

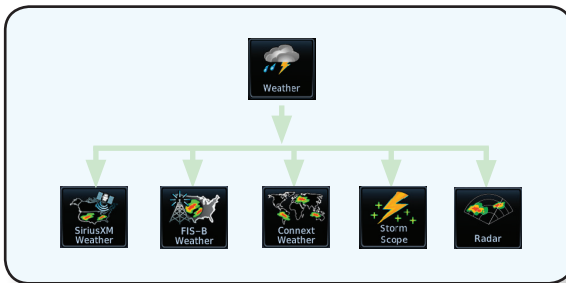

Figure 12-2 Weather Page Functional Diagram



NOTE: In data link weather, Temporary Flight Restrictions (TFRs) and Notices to Airmen (NOTAMS) that do not have geographical locations cannot be viewed on the GTN.



NOTE: Stormscope and XM Lightning are mutually exclusive.



WARNING: Do not use data link weather information for maneuvering in, near, or around areas of hazardous weather. Information contained within data link weather products may not accurately depict current weather conditions.



NOTE: Do not rely solely upon data link services to provide Temporary Flight Restriction (TFR) information. Always confirm TFR information through official sources such as Flight Service Stations or Air Traffic Control.

12.1 SiriusXM Weather Products (Optional)

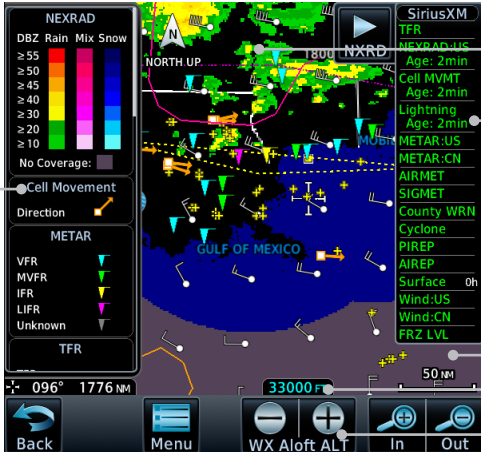
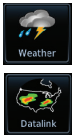

Figure 12-3 SiriusXM Weather Functional Diagram

12.1.1 Displaying SiriusXM Weather

To display SiriusXM Weather information:

1. Touch the **Weather** key on the Home page and then touch the **SiriusXM** key.



Weather Product Legends

NEXRAD Weather

Age Of Selected Weather Products

Out Of Coverage Area

Selected Altitude

Touch + or - To Select Altitude

Figure 12-4 SiriusXM Weather Page

2. While viewing the Data Link weather page, touch the **Menu** key to configure the Data Link Weather page.



Touch NEXRAD Key To Select Off, Composite (CONUS), or Base

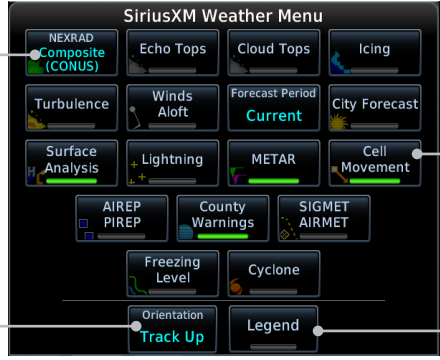

Touch Keys To Select Weather Product. Green Bar Indicates Selected Product.

Weather Overlay Map Orientation

Touch Legend Key To Display Legend

Figure 12-5 SiriusXM Weather Menu

3. Once you selected what items you want to display, touch **BACK** to return to the Data Link Weather page.



Foreword
Getting Started
Audio & Xpdr Ctrl
Com/Nav
FPL
Direct-To
Proc
Charts
Wpt Info
Map
Traffic
Terrain
Weather
Nearest
Services/Music
Utilities
System
Messages
Symbols
Appendix
Index

4. Touch the SiriusXM timestamp to view the age of all selected weather products.

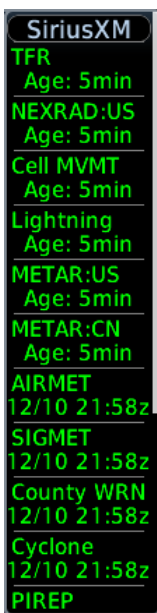

Figure 12-6 Timestamp Display



NOTE: The Timestamp is collapsed when all weather products are current (software v6.30 and later).

12.1.2 Weather Legend

The **Legend** key displays a pop-up legend of the currently displayed weather products.

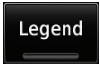

1. While viewing the Data Link Weather menu, touch the **Legend** key.

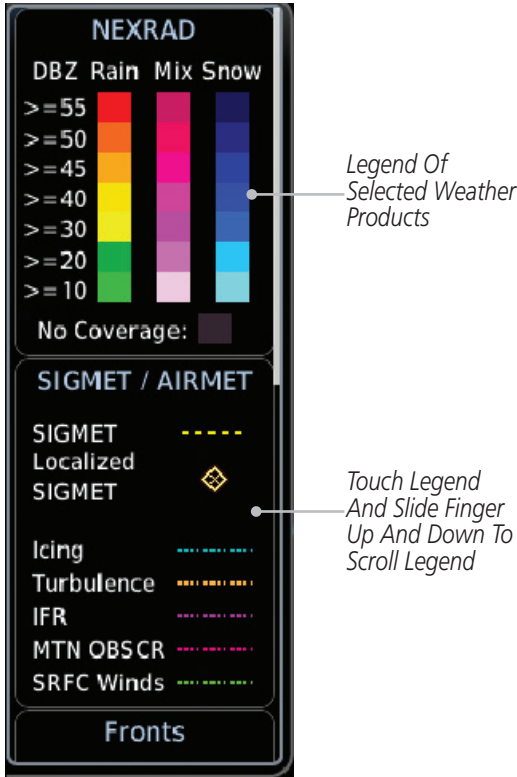
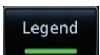

Figure 12-7 Weather Legend Display

2. Touch the Legend area of the display and while maintaining light pressure against the display, drag your finger up or down to scroll through the legend display for the selected weather products, or use the **Up/Down** keys.
3. Touch the **Legend** key again to remove the Legend.



Foreword
Getting Started
Audio & Xpdr Ctrl
Com/Nav
FPL
Direct-To
Proc
Charts
Wpt Info
Map
Traffic
Terrain
Weather
Nearest
Services/
Music
Utilities
System



Figure 12-8 Available Weather Legends

12.1.3 Weather Map Orientation

1. While viewing the Weather Data Link function, touch the **Menu** key.
2. Touch the **Orientation** key to toggle the map view orientation choices of North Up, Track Up, and Heading Up.



Messages
Symbols
Appendix
Index

12.1.4 SiriusXM Product Age

When a weather product is active on the Map function or the Weather Data Link function is selected, the age of the data is displayed on the screen. The age of the data may not indicate the time between the current GPS time and the time when the data is assembled, but rather a general indication of the time elapsed from when the data is received by the GTN.

Updated weather data may or may not contain new weather data. Weather data is refreshed at intervals that are defined and controlled by SiriusXM Satellite Radio and its data vendors.

If for any reason, a weather product is not refreshed within the designated intervals, the data is considered expired and is removed from the display. This ensures that the displayed data is consistent with what is currently being broadcast by SiriusXM Satellite Radio services. If more than half of the designated time has elapsed from the time the data is received, the color of the product age displayed changes to yellow.



WARNING: Do not use the indicated data link weather product age to determine the age of the weather information shown by the data link weather product. Due to time delays inherent in gathering and processing weather data for data link transmission, the weather information shown by the data link weather product may be significantly older than the indicated weather product age.

The expiration time is an elapsed time after which the data is considered expired and is removed from the display. This ensures that the displayed data is consistent with what is currently being broadcast by SiriusXM Satellite Radio services. If more than half of the expiration time has elapsed from the time the data is received, the color of the product age displayed changes to yellow.

The SiriusXM Weather broadcast interval is the time interval when SiriusXM Satellite Radio broadcasts new signals that may or may not contain new weather data. Weather data is broadcast at intervals that are defined and controlled by SiriusXM Satellite Radio.



NOTE: SiriusXM Weather does not provide a timestamp for AIRMETS, SIGMETs, City Forecasts, County Warnings, Cell Movement and TFR products. Therefore, the unit does not display a product age indication for these products.

Foreword



NOTE: The unit displays valid times on the weather map in lieu of product age indications for SiriusXM Weather Icing Potential, Winds Aloft, and Turbulence weather products.

Getting Started

Audio & Xpdr Ctrl



NOTE: The unit displays product age for SiriusXM Weather Freezing Level and Canada Winds Aloft weather products. The product age indication represents the number of minutes that have elapsed since the weather product was provided by SiriusXM Weather. The unit does not display the valid times assigned to the information within these products.

Com/Nav

FPL

Direct-To

Proc

Charts

Wpt Info

Map

Traffic

Terrain

Weather

Nearest

Services/
Music

Utilities

System

Messages

Symbols

Appendix

Index

12.1.5 NEXRAD

WSR-88D, or NEXRAD (NEXt-generation RADar), is a network of 158 high-resolution Doppler radar systems that are operated by the National Weather Service (NWS). NEXRAD data provides centralized meteorological information for the continental United States and selected overseas locations. The maximum range of a single NEXRAD radar site is 250 NM. The NEXRAD network provides important information about severe weather for air traffic safety.

NEXRAD data is not real-time. The lapsed time between collection, processing, and dissemination of NEXRAD images can be significant and may not reflect the current radar synopsis. Due to the inherent delays and the relative age of the data, it should be used for long-range planning purposes only. Never use NEXRAD data for maneuvering in, near, or around areas of hazardous weather. Instead, use it in an early-warning capacity of pre-departure and en route evaluation.

NEXRAD weather radar displays a mosaic of precipitation data, colored according to reflectivity. Composite reflectivity images depict the highest radar energy received from multiple antenna tilt angles at various altitudes. Base reflectivity images depict returns from the lowest antenna tilt angle.



NOTE: Due to similarities in color schemes, the display of Echo Tops cannot be shown with Cloud Tops and NEXRAD.



1. While viewing the SiriusXM Weather menu, touch the **NEXRAD** key to display the NEXRAD selections.

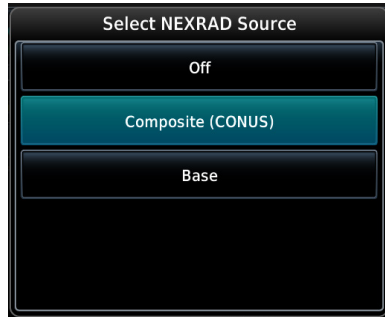

Figure 12-9 SiriusXM NEXRAD Weather Selection



NOTE: Depending on the SXM service and installed GDL hardware, radar base reflectivity imaging may have broader coverage within North America or be limited to only Canada.

2. Touch the desired **NEXRAD** source selection and then the **Back** key to view the weather information.



Figure 12-10 SiriusXM NEXRAD Weather

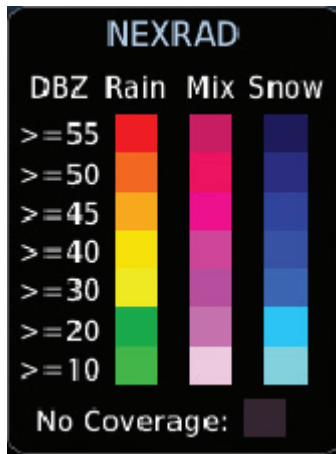

Figure 12-11 NEXRAD Weather Legend

12.1.5.1 Reflectivity

Reflectivity is the amount of transmitted power returned to the radar receiver. Colors on the NEXRAD display directly correlate to the level of detected reflectivity. Reflectivity as it relates to hazardous weather can be very complex.

The role of radar is essentially to detect moisture in the atmosphere. Simply put, certain types of weather reflect radar better than others. The intensity of a radar reflection is not necessarily an indication of the weather hazard level. For instance, wet hail returns a strong radar reflection, while dry hail does not. Both wet and dry hail can be extremely hazardous.

The different NEXRAD echo intensities are measured in decibels (dB) relative to reflectivity (Z). NEXRAD measures the radar reflectivity ratio, or the energy reflected back to the radar receiver (designated by the letter Z). The value of Z increases as the returned signal strength increases.

- Foreword
- Getting Started
- Audio & Xpdr Ctrl
- Com/Nav
- FPL
- Direct-To
- Proc
- Charts
- Wpt Info
- Map
- Traffic
- Terrain
- Weather**
- Nearest
- Services/ Music
- Utilities
- System
- Messages
- Symbols
- Appendix
- Index

12.1.5.2 NEXRAD Limitations

NEXRAD radar images may have certain limitations:

- NEXRAD base reflectivity does not provide sufficient information to determine cloud layers or precipitation characteristics. For example, it is not possible to distinguish between wet snow, wet hail, and rain.
- NEXRAD base reflectivity is sampled at the minimum antenna elevation angle. An individual NEXRAD site cannot depict high altitude storms at close ranges. It has no information about storms directly over the site.
- In the Cell Movement function, “Base” height is actually the height of maximum radar reflection and that the “Base” and “Top” heights are based on radar height and not MSL or AGL.
- Each square block on the display represents an area of four square kilometers (2.15 NM²). The intensity level reflected by each square represents the highest level of NEXRAD data sampled within the area.

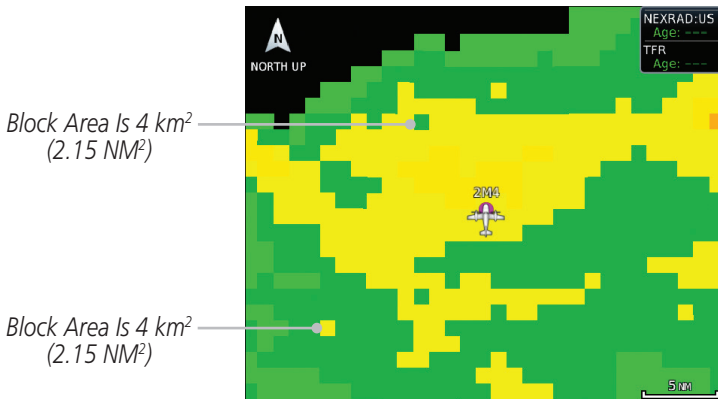

Figure 12-12 NEXRAD Data Blocks

The following may cause abnormalities in displayed NEXRAD radar images:

- Ground clutter
- Strokes and spurious radar data
- Sun strokes (when the radar antenna points directly at the sun)
- Interference from buildings or mountains, which may cause shadows
- Metallic dust from military aircraft, which can cause alterations in radar scans

NEXRAD Limitations (Canada)

- Radar coverage extends to 55°N.
- Any precipitation displayed between 52°N and 55°N is displayed as mixed because it is unknown.

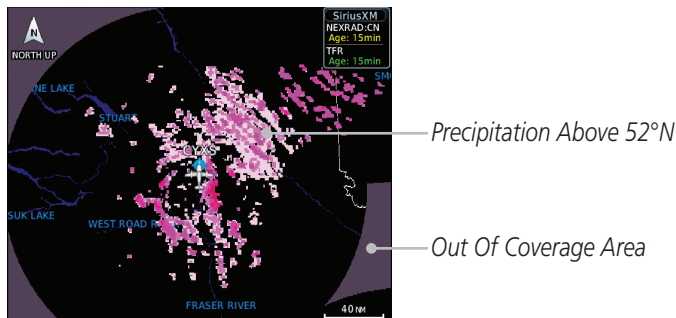

Figure 12-13 NEXRAD Data - Canada

12.1.5.3 Animating NEXRAD



NOTE: Animated NEXRAD functionality is available in software v6.00 and later.

When US or Canada NEXRAD is enabled for display and more than two NEXRAD images have been received by the GTN, the NEXRAD display can be animated on the SiriusXM Weather page. As new NEXRAD images are received, the GTN will automatically store them for future animation. The GTN can animate up to six NEXRAD images from oldest to newest, showing each for one second and the newest for two seconds.

Touch To Start NEXRAD Animation

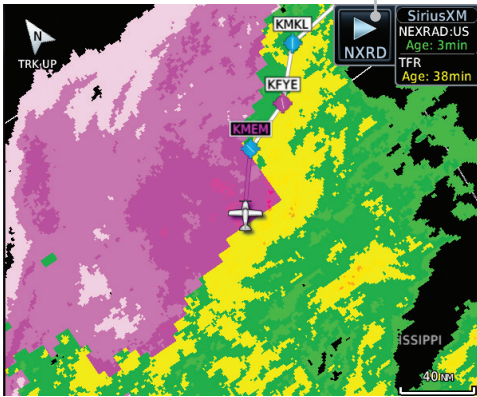

Product Age

Figure 12-14 Start NEXRAD Animation



1. While viewing the SiriusXM Weather page with NEXRAD enabled for display, touch the **NEXRD** key to start the NEXRAD animation.



NOTE: Weather Forecast, Cloud Tops, and Cell Movement will automatically be turned off while NEXRAD is animating.



2. Touch the **NEXRD** key to stop the NEXRAD animation. The animation will also stop when leaving the page or turning off NEXRAD on the SiriusXM weather page.

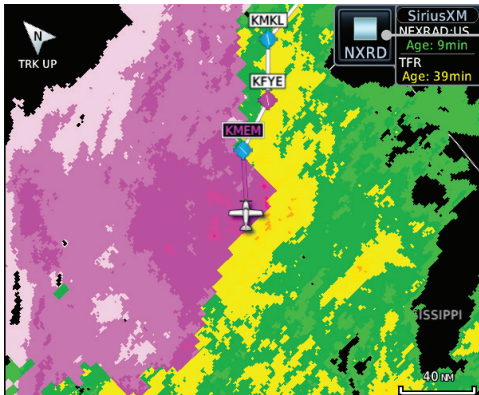

Touch To Stop NEXRAD Animation

Figure 12-15 Start NEXRAD Animation

Foreword

Getting Started

Audio & Xpdr Ctrl

Com/Nav

FPL

Direct-To

Proc

Charts

Wpt Info

Map

Traffic

Terrain

Weather

Nearest

Services/ Music

Utilities

System

Messages

Symbols

Appendix

12.1.6 Echo Tops

Echo Tops data shows the location, elevation, and direction of the highest radar echo. The highest radar echo does not indicate the top of a storm or clouds; rather it indicates the highest altitude at which precipitation is detected. This information is determined from NEXRAD data.



NOTE: Due to similarities in color schemes, the display of Echo Tops cannot be shown with Cloud Tops and NEXRAD.

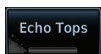

1. While viewing the Data Link Weather menu, touch the **Echo Tops** key.

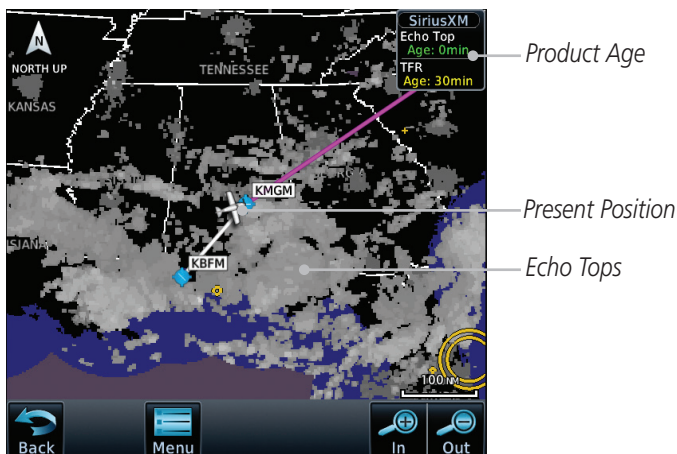
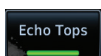

Figure 12-16 Echo Tops



2. Touch the **Echo Tops** key again to turn it off.

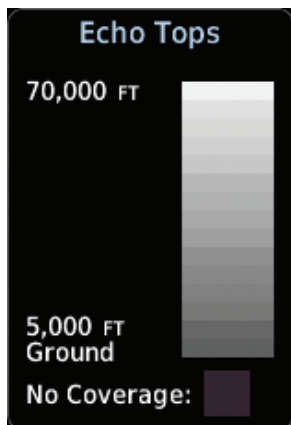

Figure 12-17 Echo Tops Legend

12.1.7 Cloud Tops



NOTE: Due to similarities in color schemes, it is not possible to display Echo Tops and Cloud Tops at the same time.

Cloud tops data depicts cloud top altitudes as determined from satellite imagery.



1. While viewing the Data Link Weather menu, touch the **Cloud Tops** key.

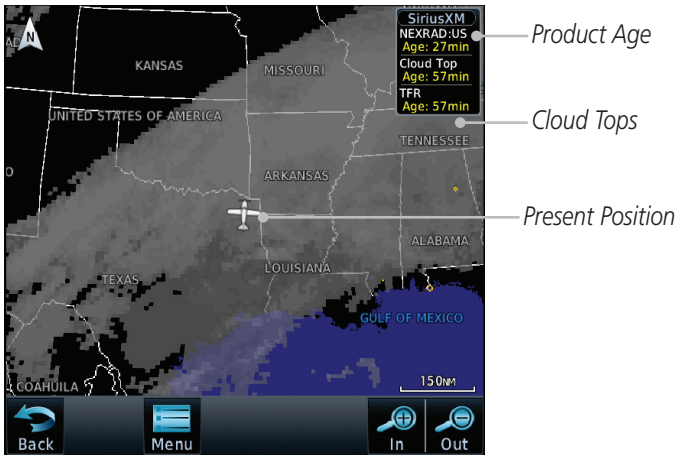
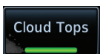

Figure 12-18 Cloud Tops



2. Touch the **Cloud Tops** key again to turn it off.

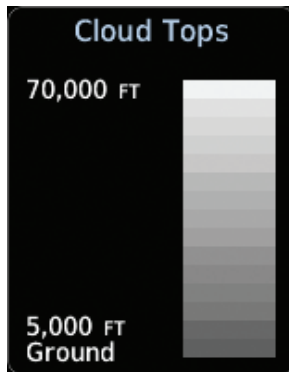

Figure 12-19 Cloud Tops Legend

12.1.8 Cell Movement

Cell Movement data shows the location and movement of storm cells as identified by a ground-based system. Cells are represented by yellow squares, with direction of movement indicated with short, orange arrows.



NOTE: In the Cell Movement function, “Base” height is actually the height of maximum radar reflection and that the “Base” and “Top” heights are based on radar height and not MSL or AGL.



1. While viewing the Data Link Weather menu, touch the **Cell Movement** key.

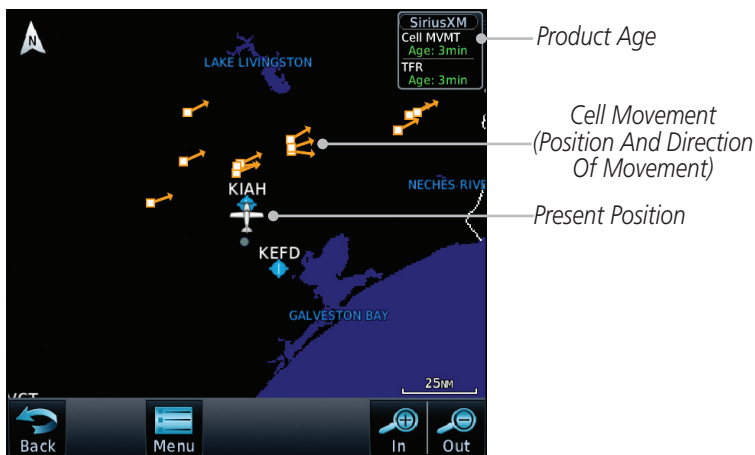

Figure 12-20 Cell Movement



2. Touch a Cell Movement icon to view cell details.



Figure 12-21 Cell Movement Detail



3. In the Menu, Touch the **Cell Movement** key again to turn it off.

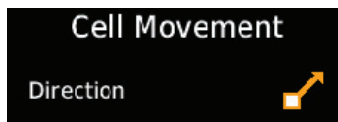

Figure 12-22 Cell Movement Legend

12.1.9 SIGMETs and AIRMETs

SIGMETs (SIGnificant METeological Information) and AIRMETs (AIRmen's METeological Information) are broadcast for potentially hazardous weather considered of importance to aircraft.



1. While viewing the Data Link Weather menu, touch the **SIGMET/AIRMET** key.

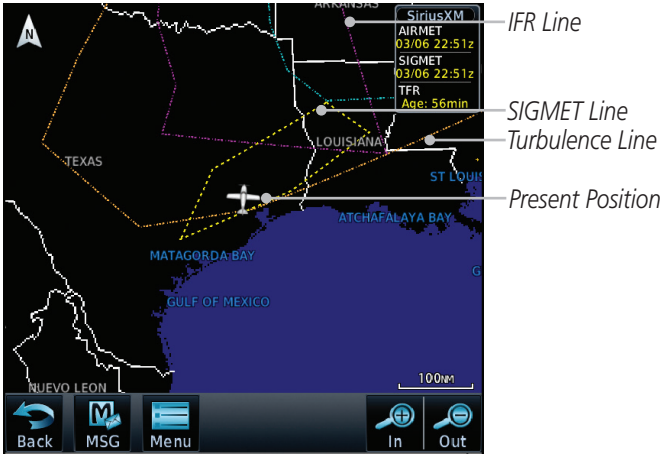

Figure 12-23 SIGMETs and AIRMETs



2. Touch the **SIGMET/AIRMET** key again to turn it off.



Figure 12-24 SIGMET/AIRMET Legend

12.1.10 County Warnings

County Warnings data provides specific public awareness and protection weather warnings from the National Weather Service. This can include information on fires, tornadoes, severe thunderstorms, flood conditions, and other natural disasters.



1. While viewing the Data Link Weather menu, touch the **County Warnings** key. Touch the County Warnings symbol for detailed information.

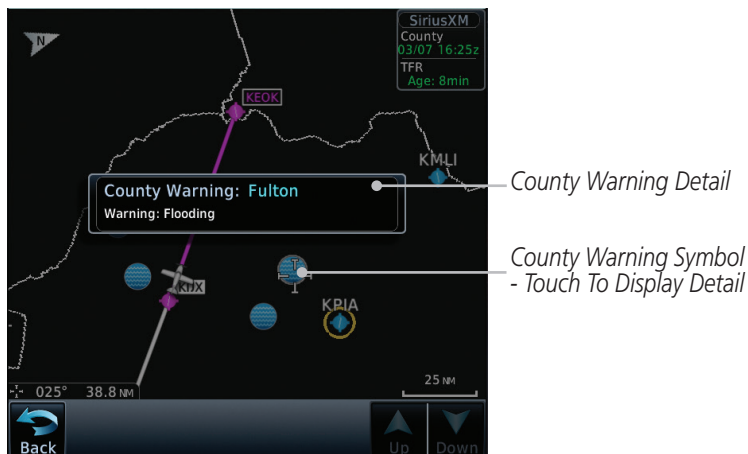

Figure 12-25 County Warnings Data



2. Touch the **County Warnings** key again to turn it off.

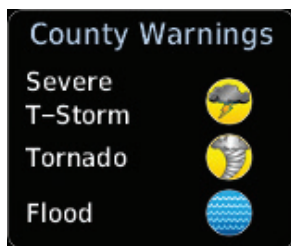

Figure 12-26 County Warnings Legend

12.1.11 Freezing Level

Freezing Level data shows the color-coded contour lines for the altitude and location at which the Freezing Level is found. When no data is displayed for a given altitude, the data for that altitude has not been received, or is out of date and has been removed from the display. New data appears on the next update.



1. While viewing the Data Link Weather menu, touch the **Freezing Level** key.



Figure 12-27 Freezing Level



2. Touch the **Freezing Level** key again to turn it off.



Figure 12-28 Freezing Level Legend

12.1.12 METARs

METAR (METeorological Aerodrome Report), known as an Aviation Routine Weather Report, is the standard format for current weather observations. METARs are updated hourly and are considered current. METARs typically contain information about the temperature, dew point, wind, precipitation, cloud cover, cloud heights, visibility, and barometric pressure. They can also contain information on precipitation amounts, lightning, and other critical data. METARs are shown as colored flags at airports that provide them.

1. While viewing the Data Link Weather menu, touch the **METAR** key. Touch an airport symbol for more METAR detail.

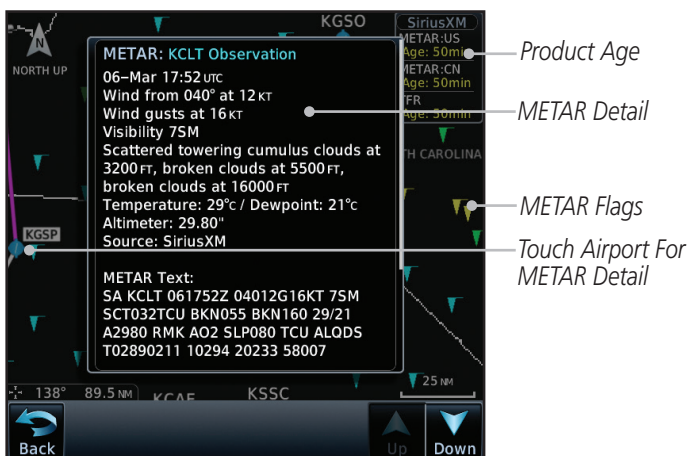

Figure 12-29 METARs

2. Touch the **METAR** key in the Menu again to turn it off.

METAR Symbol	Description
	VFR (ceiling greater than 3000 ft. AGL and visibility greater than five miles)
	Marginal VFR (ceiling 1000–3000 ft. AGL and/or visibility three to five miles)
	IFR (ceiling 500 to below 1000 ft. AGL and/or visibility one mile to less than three miles)
	Low IFR (ceiling below 500 ft. AGL or visibility less than one mile)
	Unknown

Table 12-27 METAR Symbols

12.1.13 Cyclone

The current location of the cyclone is shown along with its projected path with the date and time.



1. While viewing the Data Link Weather menu, touch the **Cyclone** key.



Projected Path With Date And Time

Current Position Of Cyclone

Figure 12-30 Cyclone



2. Touch the **Cyclone** key again to turn it off.

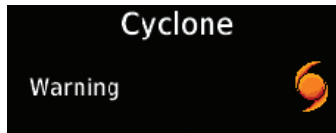

Figure 12-31 Cyclone Legend

12.1.14 Lightning

Lightning data shows the approximate location of cloud-to-ground lightning strikes. A yellow cross icon represents a strike that has occurred within a 2 kilometer (approx. 1 NM) region. The exact location of the lightning is not displayed.



1. While viewing the Data Link Weather menu, touch the **Lightning** key.

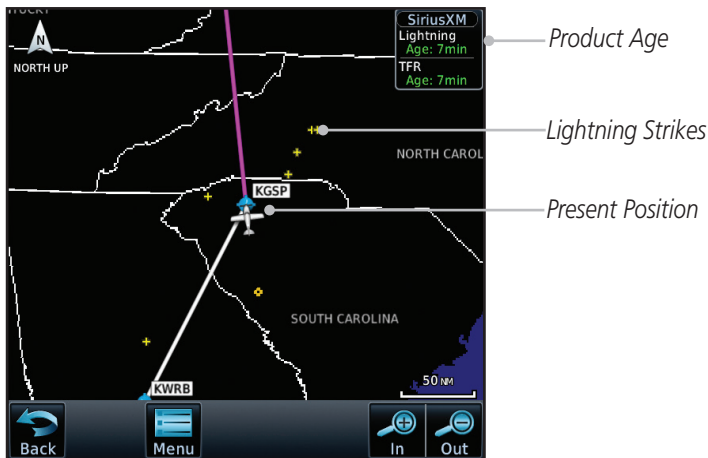

Figure 12-32 Lightning



2. Touch the **Lightning** key again to turn it off.

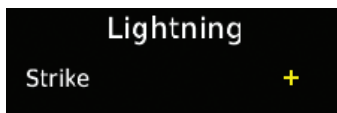

Figure 12-33 Lightning Legend

12.1.15 City Forecast

City Forecast shows current and future weather conditions for various cities.



1. While viewing the Data Link Weather menu, touch the **City Forecast** key.



2. Touch the **Forecast Period** key and select the desired time increment.

3. Touch any City Forecast symbol for weather details.

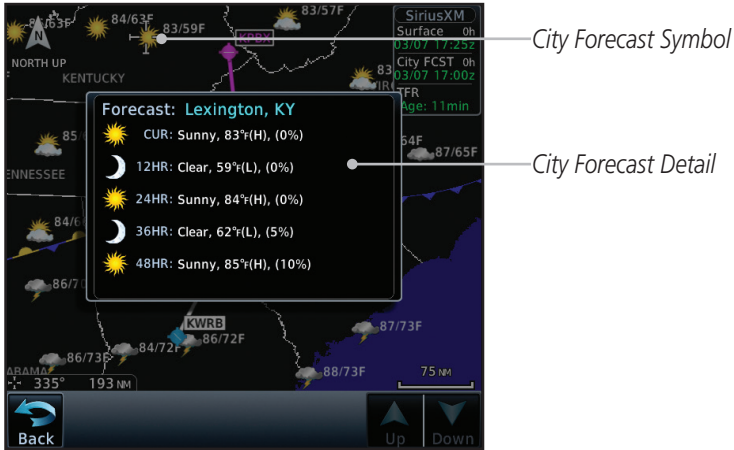

Figure 12-34 City Forecast



Figure 12-35 City Forecast Legend

Foreword

Getting Started

Audio & Xpdr Ctrl

Com/Nav

FPL

Direct-To

Proc

Charts

Wpt Info

Map

Traffic

Terrain

Weather

Nearest

Services/ Music

Utilities

System

Messages

Symbols

Appendix

12.1.16 Surface Analysis



NOTE: In software v6.21 and earlier, Surface Analysis and City Forecast are combined features of the Weather Forecast product.

The Surface Analysis map shows regional weather forecasts for a selected time period. The map shows high and low pressure centers and their associated frontal movement.

1. While viewing the SiriusXM Weather menu, touch the **Surface Analysis** key.

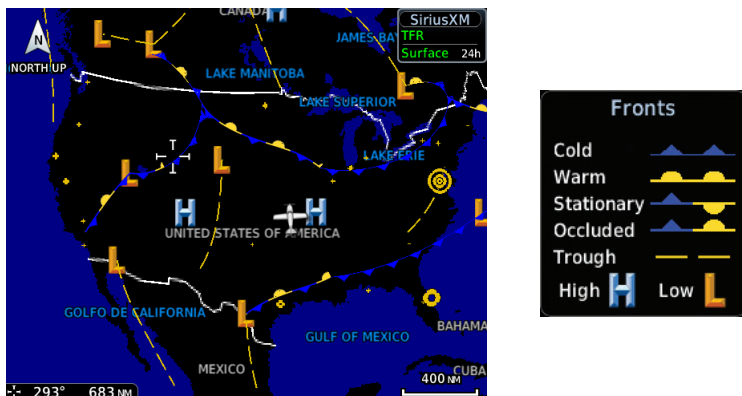

Figure 12-36 Surface Analysis and Fronts Legend

2. Touch the **Forecast Period** key and select the desired time increment.

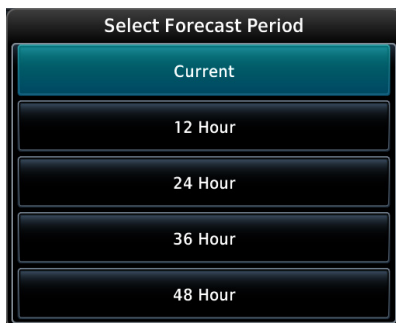

Figure 12-37 Select Forecast Time Period

Forecast Period
Current

12.1.17 Winds Aloft

Winds Aloft data shows the forecast wind speed and direction at the surface and at selected altitudes. Altitudes can be selected in 3,000 foot increments from the surface up to 45,000 feet.



1. While viewing the Data Link Weather menu, touch the **Winds Aloft** key.

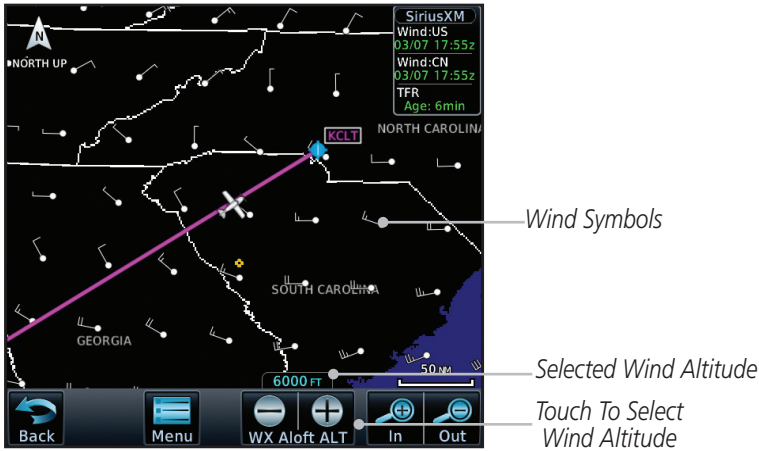

Figure 12-38 Winds Aloft



2. Touch the **WX Aloft ALT** **−** or **+** keys to increase or decrease the reporting altitude of the winds aloft in 3,000 foot increments. The selected altitude is shown in a window above the altitude keys.



3. Touch the **Winds Aloft** key again to turn it off.

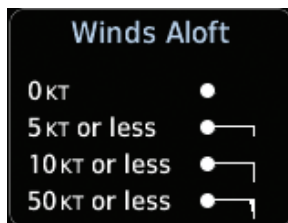
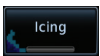

Figure 12-39 Winds Aloft Legend

12.1.18 Icing

The Icing product shows a graphic view of the current icing environment in four categories: light, moderate, severe, and extreme (not specific to aircraft type). The Icing product is not a forecast, but a presentation of the current conditions at the time of the analysis. Supercooled Large Droplet (SLD) icing conditions are characterized by the presence of relatively large, super cooled water droplets indicative of freezing drizzle and freezing rain aloft. SLD threat areas are depicted as black and red blocks over the Icing colors. Icing and SLD data are shown between 1,000 feet and 30,000 feet in 3,000 foot increments.



1. While viewing the Data Link Weather menu, touch the **Icing** key.

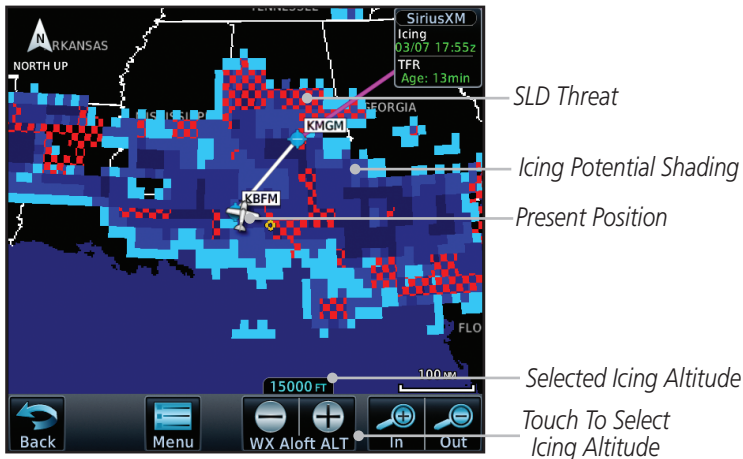
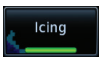

Figure 12-40 Icing and SLD



2. Touch the **WX Aloft ALT** $-$ or $+$ keys to increase or decrease the reporting altitude of icing in 3,000 foot increments. The selected altitude is shown in a window above the altitude keys.



3. Touch the **Icing** key again to turn it off.

G3 SiriusXM

G4 SiriusXM



Figure 12-41 Icing Legend

12.1.19 Turbulence

Turbulence data identifies the potential for erratic movement of high-altitude air mass associated winds. Turbulence is classified as light, moderate, severe or extreme, at altitudes between 21,000 and 45,000 feet. Turbulence data is intended to supplement AIRMETs and SIGMETs.

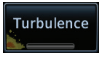

1. While viewing the Weather Data Link menu, touch the **Turbulence** key.

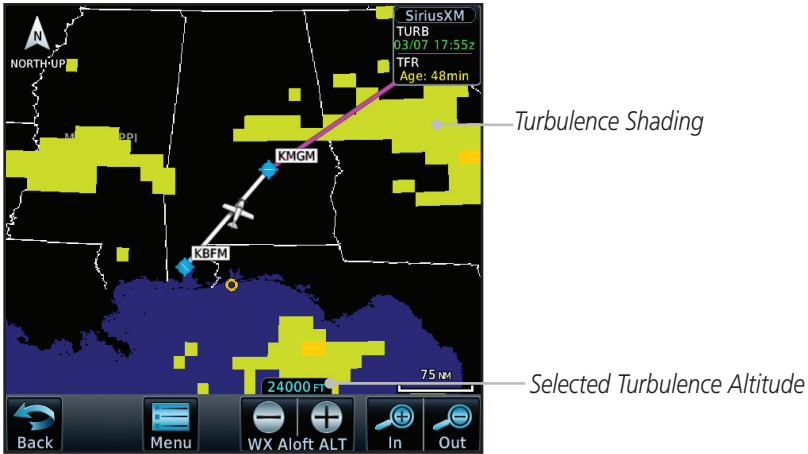
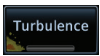

Figure 12-42 Turbulence



2. Touch the **WX Aloft ALT** **−** or **+** keys to increase or decrease the reporting altitude for turbulence in 3,000 foot increments. The selected altitude is shown in a window above the altitude keys.



3. Touch the **Turbulence** key again to turn it off.

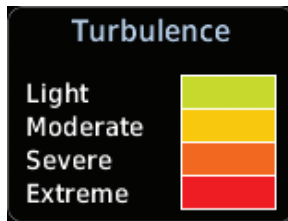

Figure 12-43 Turbulence Legend

12.1.20 AIREP/PIREP

Pilot Weather Reports (PIREPs) provide timely weather information for a particular route of flight. When significant weather conditions are reported or forecast, Air Traffic Control (ATC) facilities are required to solicit PIREPs. A PIREP may contain non-forecast adverse weather conditions, such as low in-flight visibility, icing conditions, wind shear, and turbulence. PIREPs are issued as either Routine (UA) or Urgent (UUA).



1. While viewing the Data Link Weather menu, touch the **AIREP/PIREP** key.



Figure 12-44 Weather Display With AIREP/PIREP Information Active

2. Touch a weather information symbol to view details for that item.

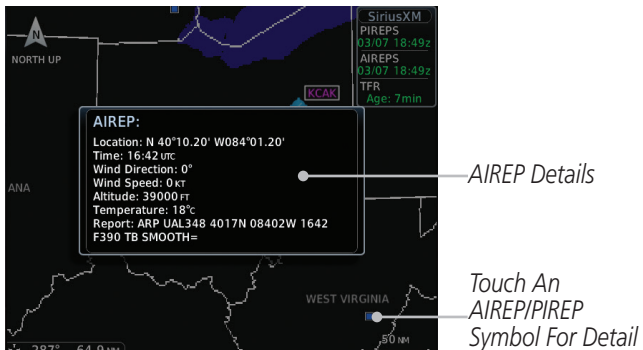

Figure 12-45 AIREP/PIREP Information Detail



3. Touch the **Back** key to remove the detailed information.



4. Touch the **AIREP/PIREP** key again to turn it off.

Foreword
Getting Started
Audio & Xpdr Ctrl
Com/Nav
FPL
Direct-To
Proc
Charts
Wpt Info
Map
Traffic
Terrain
Weather
Nearest
Services/Music
Utilities
System
Messages
Symbols
Appendix
Index

12.2 StormScope® Weather

12.2.1 StormScope® (Optional)



NOTE: Refer to the WX-500 Pilot's Guide for a detailed description of the WX-500 StormScope.

The WX-500 StormScope Weather Mapping Sensor is a passive weather avoidance system that detects electrical discharges associated with thunderstorms within a 200 NM radius of the aircraft. The StormScope measures relative bearing and distance of thunderstorm-related electrical activity and reports the information to the display. **Interfaces are currently only available for the WX-500 StormScope System.**

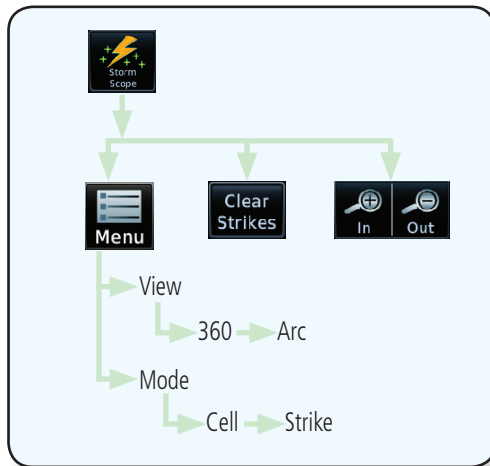

Figure 12-46 StormScope Functional Diagram

For lightning display interpretation, study the examples in the WX-500 Pilot's Guide that are designed to help you relate the cell or strike patterns shown on the display to the size and location of thunderstorms that may be near your aircraft.





Symbol	Description
	6
	60
	120
	180

Table 12-28 StormScope Symbols

- From the Home page, touch the **Weather** key (and then the **StormScope** key if present) to reach the StormScope function.

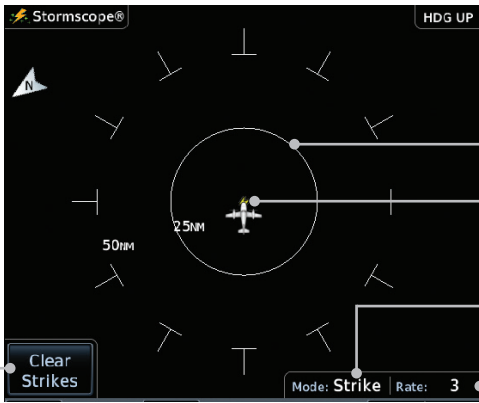

Orientation
Annunciation.
HDG N/A - Heading Is
Not Available.

Range Ring

Lightning Strikes

Lightning
Display Mode
(Cell or Strike)

Lightning
Strike Rate

Touch
To Clear
Lightning
Strikes

Figure 12-47 StormScope Display (360° Display View Shown)

- Touch the **Menu** key to setup the StormScope display.



Arc View
Selected

Lightning
Display Mode
(Strike Selected)

Figure 12-48 StormScope Menu

- Touch the **360°** or **Arc** to select the display view.

12.2.2 Clearing the StormScope® Page

Routinely clearing the StormScope Page of all discharge points is a good way to determine if a storm is building or dissipating. In a building storm discharge points reappear faster and in larger numbers. In a dissipating storm discharge points appear slower and in smaller numbers.



1. While viewing the Weather StormScope page, touch the **Clear Strikes** key to clear lightning strikes.
2. Lightning strikes will be cleared from the display and the Rate value will be reset.



NOTE: The GTN displays StormScope data with or without a heading source. If no heading source is available, the "HDG N/A" annunciation appears in the upper right corner of the page. When flying without a heading source, the pilot must clear all strikes following each heading change.

12.2.3 Changing the StormScope® Display View

The Lightning Page displays either a 360° or a 120° viewing angle.



1. While viewing the Weather StormScope page, touch **MENU**.
2. Touch the **360°** or **Arc** to select the display view.

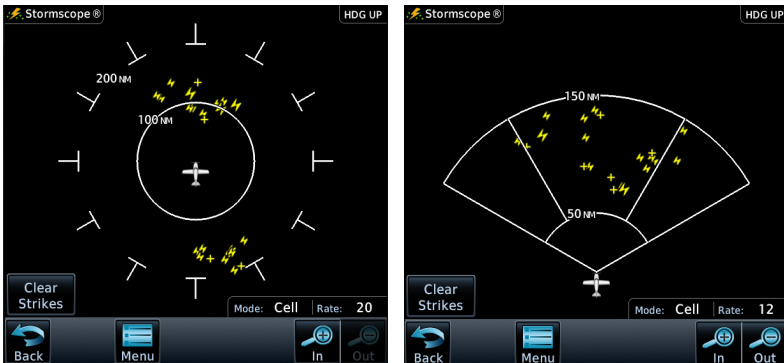

Figure 12-49 StormScope 360° and Arc Display Views

12.2.4 Changing the StormScope® Data Mode

Cell display mode uses a clustering program to locate storm cells instead of individual discharge points. This mode is most useful during periods of heavy storm activity. Strike display mode is used during periods of light electrical activity. It is useful in plotting initial lightning discharges associated with a building thunderstorm.



1. While viewing the Weather StormScope page, touch **MENU**.



2. Touch **Cell** or **Strike** to select the display mode.



12.2.5 Changing the StormScope® Data Display Range

StormScope data can be displayed on the Map page 2,000 NM zoom scale, but the data only goes out as far as the StormScope can report (200 NM). The 500 NM zoom scale will display all lightning data. Scales greater than 500 NM do not display any additional StormScope data.



While viewing the StormScope page touch the **In** and **Out** keys to display a larger or smaller area.

12.2.6 Displaying StormScope® Data on the Map Page

The Map Page displays cell or strike information using yellow lightning strike symbology overlaid on a moving map. This added capability improves situational awareness, which in turn makes it much easier for the pilot to relate storm activity to airports, NAVAIDs, obstacles and other ground references. For details about viewing Stormscope data on the Map page, refer to section 9.1.1.7.



NOTE: The selected lightning display type, cell or strike, will be shown the same on both the StormScope and the Map pages.

12.3 Weather Radar

The GTN 7XX can display weather radar from a Garmin GWX system or from selected 3rd party radars. Only one weather radar system may be interfaced to the system. For detailed information on the operation of 3rd party radars, refer to their specific documentation.

12.3.1 Garmin GWX Radar Description

The Garmin GWX Airborne Color Weather Radars combine excellent range and adjustable scanning profiles with a high-definition target display.

To focus radar scanning on specific areas, Sector Scanning offers pilot-adjustable horizontal scan angles of 20°, 40°, 60°, or 90° (up to 120° with GWX 70/75/80). A vertical scanning function helps to analyze storm tops, gradients, and cell buildup activity at various altitudes.

See the documentation of each radar for specific features.

12.3.1.1 Principles of Pulsed Airborne Weather Radar

The term RADAR is an acronym for RAdio Detecting and Ranging. Pulsed radar locates targets by transmitting a microwave pulse beam that, upon encountering a target, is then reflected back to the radar receiver as a return “echo.” The microwave pulses are focused and radiated by the antenna, with the most intense energy in the center of the beam and decreasing intensity near the edge. The same antenna is used for both transmitting and receiving. The returned signal is then processed and displayed on the GTN 7XX.

Radar detection is a two-way process that requires 12.36 micro-seconds for the transmitted microwave pulses to travel out and back for each nautical mile of target range. It takes 123.6 micro-seconds for a transmitted pulse to make the round trip if a target is 10 NM away.

The GWX weather radar should be used to avoid severe weather, not for penetrating severe weather. The decision to fly into an area of radar targets depends on target intensity, spacing between the targets, aircraft capabilities and pilot experience. Pulse type weather radar detects only precipitation, not clouds or turbulence. The display may indicate clear areas between intense returns, but this does not necessarily mean it is safe to fly between them. Only Doppler radar can detect turbulence.

Foreword

Getting Started

Audio & Xpdr Ctrl

Com/Nav

FPL

Direct-To

Proc

Charts

Wpt Info

Map

Traffic

Terrain

Weather

Nearest

Services/ Music

Utilities

System

Messages

Symbols

Appendix

Airborne weather radar has other capabilities beyond weather detection. It also has the ability to detect and provide distance to objects on the ground, such as, cities, mountains, coastlines, rivers, lakes, and oceans.

12.3.1.2 Antenna Beam Illumination

It is important to understand the concept of the antenna beam illumination. The radar beam is much like the beam of a spotlight. The farther the beam travels, the wider it gets. The radar is only capable of “seeing” what is inside the boundaries of the beam.

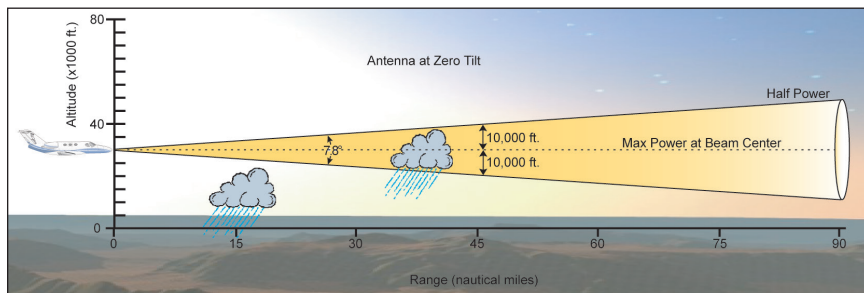

Figure 12-50 Radar Beam from 12 inch Antenna

The vertical dimensions of the radar beam are shown in the figure above and the same holds true for the horizontal dimensions. In other words, the beam will be as wide as it is tall. Note that it is possible not to see areas of precipitation on the radar display because of the antenna tilt setting. With the antenna tilt set to zero in this illustration, the beam overshoots the precipitation at 15 NM. The curvature of the earth can also be a factor, especially at range settings of 150 NM or more.

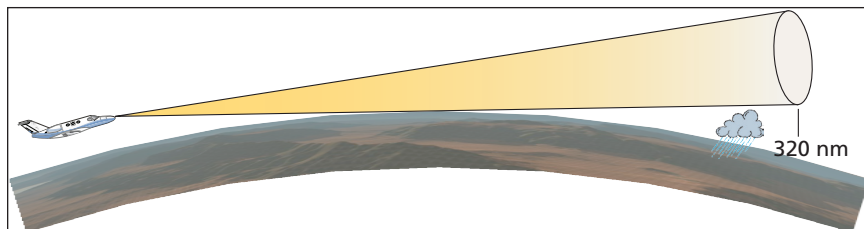

Figure 12-51 Radar Beam in Relation to the Curvature of the Earth

- Foreword
- Getting Started
- Audio & Xpdr Ctrl
- Com/Nav
- FPL
- Direct-To
- Proc
- Charts
- Wpt Info
- Map
- Traffic
- Terrain
- Weather
- Nearest
- Services/ Music
- Utilities
- System
- Messages
- Symbols
- Appendix

12.3.1.3 Radar Signal Attenuation

The phenomena of weather attenuation needs to be kept in mind whenever operating the weather radar. When the radar signal is transmitted, it is progressively absorbed and scattered, making the signal weaker. This weakening, or attenuation, is caused by two primary sources, distance and precipitation.

Attenuation because of distance is due to the fact that the amount of radar energy at a distance from the antenna is inversely proportional to the square of the distance. The reflected radar energy from a target 40 miles away that fills the radar beam will be one fourth the energy reflected from an equivalent target 20 miles away. This would appear to the operator that the storm is gaining intensity as the aircraft gets closer. Internal circuitry within the GWX system compensates for much of this distance attenuation.

Attenuation due to precipitation is not as predictable as distance attenuation. It is also more intense. As the radar signal passes through moisture, a portion of the radar energy is reflected back to the antenna. However, much of the energy is absorbed. If precipitation is very heavy, or covers a large area, the signal may not reach completely through the area of precipitation. The weather radar system cannot distinguish between an attenuated signal and area of no precipitation. If the signal has been fully attenuated, the radar will display a “radar shadow.” This appears as an end to the precipitation when, in fact, the heavy rain may extend much further. A cell containing heavy precipitation may block another cell located behind the first, preventing it from being displayed on the radar. Never fly into these shadowed areas and never assume that all of the heavy precipitation is being displayed unless another cell or a ground target can be seen beyond the heavy cell. The WATCH™ feature of the GWX Weather Radar system can help in identifying these shadowed areas. Areas in question will appear as “shadowed” or gray area on the radar display. Proper use of the antenna tilt control can also help detect radar shadows.

Attenuation can also be due to poor maintenance or degradation of the radome. Even the smallest amount of wear and tear, pitting, and pinholes on the radome surface can cause damage and system inefficiency.

Foreword

Getting Started

Audio & Xpdr Ctrl

Com/Nav

FPL

Direct-To

Proc

Charts

Wpt Info

Map

Traffic

Terrain

Weather

Nearest

Services/ Music

Utilities

System

Messages

Symbols

Appendix

12.3.2 Radar Signal Reflectivity

12.3.2.1 Precipitation

Precipitation or objects more dense than water, such as earth or solid structures, will be detected by the weather radar. The weather radar will not detect clouds, thunderstorms or turbulence directly. It detects precipitation associated with clouds, thunderstorms, and turbulence. The best radar signal reflectors are raindrops, wet snow or wet hail. The larger the raindrop the better it reflects. The size of the precipitation droplet is the most important factor in radar reflectivity. Because large drops in a small concentrated area are characteristic of a severe thunderstorm, the radar displays the storm as a strong return. Ice, dry snow, and dry hail have low reflective levels and often will not be displayed by the radar. A cloud that contains only small raindrops, such as fog or drizzle, will not reflect enough radar energy to produce a measurable target return.

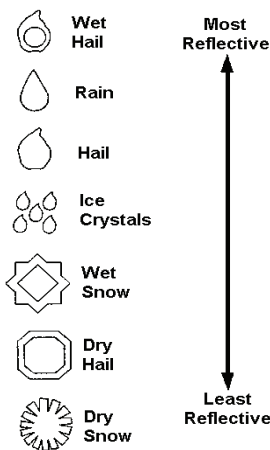

Figure 12-52 Precipitation Type and Reflectivity

- Foreword
- Getting Started
- Audio & Xpdr Ctrl
- Com/Nav
- FPL
- Direct-To
- Proc
- Charts
- Wpt Info
- Map
- Traffic
- Terrain
- Weather
- Nearest
- Services/ Music
- Utilities
- System
- Messages
- Symbols
- Appendix

12.3.2.2 Ground Returns

The intensity of ground target returns depends upon the angle at which the radar beam strikes the ground target (Angle of Incidence) and the reflective properties of that target. The gain can be adjusted so shorelines, rivers, lakes, and cities are well defined. Increasing gain too much causes the display to fill in between targets, thus obscuring some landmarks.

Cities normally provide a strong return signal. While large buildings and structures provide good returns, small buildings can be shadowed from the radar beam by the taller buildings. As the aircraft approaches, and shorter ranges are selected, details become more noticeable as the highly reflective regular lines and edges of the city become more defined.

Bodies of water such as lakes, rivers, and oceans are not good reflectors, and normally do not provide good returns. The energy is reflected in a forward scatter angle with inadequate energy being returned. They can appear as dark areas on the display. However, rough or choppy water is a better reflector and will provide stronger returns from the downwind sides of the waves.

Mountains also provide strong return signals to the antenna, but also block the areas behind. However, over mountainous terrain, the radar beam can be reflected back and forth in the mountain passes or off canyon walls using up all or most of the radar energy. **In this case, no return signal is received from this area causing the display to show a dark spot which could indicate a pass where no pass exists.**

12.3.2.3 Angle of Incidence

The angle at which the radar beam strikes the target is called the Angle of Incidence. Incident angle (“A”) is illustrated below. This directly affects the detectable range, the area of illumination, and the intensity of the displayed target returns. A large incident angle gives the radar system a smaller detectable range and lower display intensity due to minimized reflection of the radar energy.

Foreword

Getting Started

Audio & Xpdr Ctrl

Com/Nav

FPL

Direct-To

Proc

Charts

Wpt Info

Map

Traffic

Terrain

Weather

Nearest

Services/ Music

Utilities

System

Messages

Symbols

Appendix

- Foreword
- Getting Started
- Audio & Xpdr Ctrl
- Com/Nav
- FPL
- Direct-To
- Proc
- Charts
- Wpt Info
- Map
- Traffic
- Terrain
- Weather
- Nearest
- Services/
Music
- Utilities
- System
- Messages
- Symbols
- Appendix
- Index

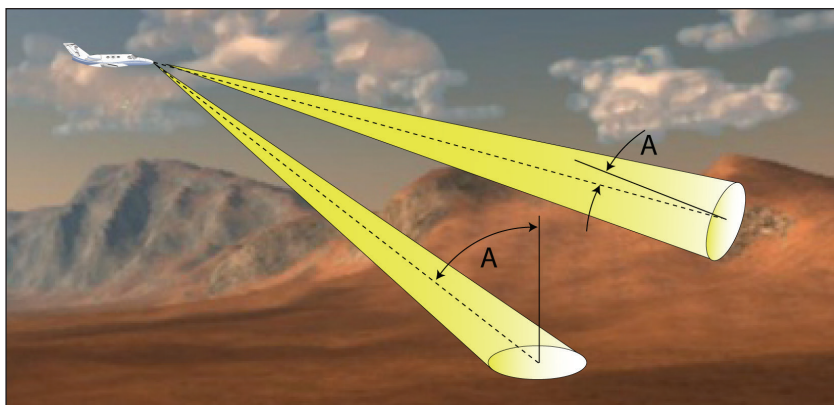

Figure 12-53 Angle of Incidence

A smaller incident angle gives the radar a larger detectable range of operation and the target display will show a higher intensity. Since more radar energy is reflected back to the antenna with a low incident angle, the resulting detectable range is increased for mountainous terrain.

12.3.3 Operating Distance

The following information establishes a minimum safe distance from the antenna for personnel near an operating airborne weather radar. The minimum safe distance is based upon the FCC's exposure limit at 9.3 to 9.5 GHz for general population/uncontrolled environments which is 1 mW/cm². See Advisory Circular 20-68B for more information on safe distance determination.

12.3.3.1 Maximum Permissible Exposure Level (MPEL) (GWX 68)

The zone in which the radiation level exceeds the US Government standard of 1 mW/cm², is the semicircular area of at least 11 feet from the 12 inch antenna as indicated in the illustration below. All personnel must remain outside of this zone. With a scanning or rotating beam, the averaged power density at the MPEL boundary is significantly reduced.

12.3.3.2 Maximum Permissible Exposure Level (MPEL) (Other Radars)

See the appropriate documentation for MPEL.

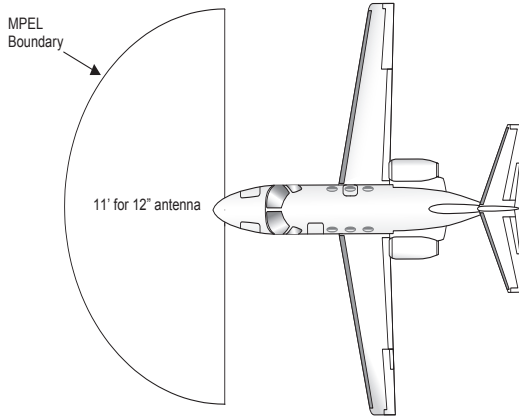

Figure 12-54 MPEL Boundary

- Foreword
- Getting Started
- Audio & Xpdr Ctrl
- Com/Nav
- FPL
- Direct-To
- Proc
- Charts
- Wpt Info
- Map
- Traffic
- Terrain
- Weather**
- Nearest
- Services/Music
- Utilities
- System
- Messages
- Symbols
- Appendix

12.3.4 Basic Antenna Tilt Setup

The following discussion is a simple method for setting up the weather radar antenna tilt for most situations. It is not to be considered an all encompassing setup that will work in all situations, but this method does provide good overall parameters for the monitoring of threats. Ultimately, it is desired to have the antenna tilted so that the bottom of the radar beam is four degrees below parallel with the ground. The following discussion explains one way of achieving this.

With the aircraft flying level, adjust the antenna tilt so ground returns are displayed at a distance that equals the aircraft's current altitude (AGL) divided by 1,000. For example, if the aircraft is at 14,000 feet, adjust the tilt so the front edge of ground returns are displayed at 14 NM. Note this antenna tilt angle setting. Now, raise the antenna tilt 6° above this setting. The bottom of the radar beam is now angled down 4° from parallel with the ground.

Practical Application Using the Basic Tilt Setup

At this point, when flying at altitudes between 2,000 and 30,000 feet AGL, any displayed target return should scrutinized. If the displayed target advances on the screen to 5 NM of the aircraft, avoid it. This may be either weather or ground returns that are 2,000 feet or less below the aircraft. Raising the antenna tilt 4° can help separate ground returns from weather returns in relatively flat terrain. This will place the bottom of the radar beam level with the ground. Return the antenna tilt to the previous setting after a few sweeps.

If the aircraft is above 29,000 feet, be cautious of any target return that gets to 30 NM or closer. This is likely a thunderstorm that has a top high enough that the aircraft cannot fly over it safely.

If the aircraft altitude is 15,000 feet or lower, set the displayed range to 60 NM. Closely monitor anything that enters the display.

Also, after setting up the antenna tilt angle as described previously, ground returns can be monitored for possible threats. The relationship between antenna tilt angle, altitude, and distance is one degree of tilt equals 100 feet of altitude for every one nautical mile.

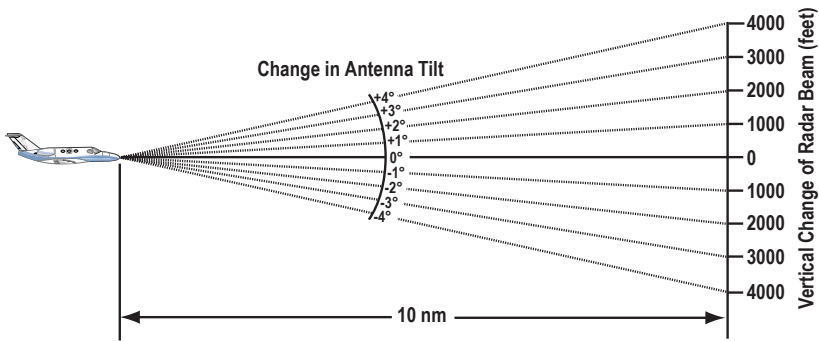

Figure 12-55 Vertical Change in Radar Beam per Nautical Mile

Therefore, with the antenna tilt set so that the bottom of the beam is four degrees below parallel with the ground, a target return at 10 NM is approximately 4,000 feet below the aircraft; at 20 NM, 8,000 feet; at 50 NM, 20,000 feet. In other words, at this tilt setting, a ground return (such as a mountain peak) being displayed at 10 NM would have a maximum distance below the aircraft of 4,000 feet. If that ground target return moves to 5 NM, maximum distance below the aircraft will be 2,000 feet.

This setup will provide a good starting point for practical use of the GWX radar. There are many other factors to consider in order to become proficient at using weather radar in all situations.

12.3.5 Weather Mapping and Interpretation

12.3.5.1 Weather display Interpretation

When evaluating various target returns on the weather radar display, the colors denote approximate rainfall intensity and rates as shown in the table below.

Weather Mode Color	GWX 68 Radars		GWX 70 Radars	3rd Party Radars
	Approximate Intensity	Approximate Rainfall Rate (in/hr)	Approximate Intensity	Radar Return Level (see radar documentation for details)
BLACK	< 23 dBZ	< .01	< 23 dBZ	0
GREEN	23 dBZ to < 33 dBZ	.01 - 0.1	23 dBZ to < 33 dBZ	1
YELLOW	33 dBZ to < 41 dBZ	0.1 - 0.5	33 dBZ to < 41 dBZ	2
RED	41 dBZ to < 50 dBZ	0.5 - 2	41 dBZ to < 49 dBZ	3
MAGENTA	50 dBZ and greater	> 2	> 49 dBZ	4

Table 12-29 Precipitation Intensity Levels

12.3.5.2 Thunderstorms

Updrafts and downdrafts in thunderstorms carry water through the cloud. The more severe the drafts, the greater the number and size of the precipitation droplets. With this in mind, the following interpretations can be made from what is displayed on the weather radar. Avoid these areas by an extra wide margin.

- In areas where the displayed target intensity is red or magenta (indicating large amounts of precipitation), the turbulence is considered severe.
- Areas that show steep color gradients (intense color changes) over thin bands or short distances suggest irregular rainfall rate and strong turbulence.
- Areas that show red or magenta are associated with hail or turbulence, as well as heavy precipitation. Vertical scanning and antenna tilt management may be necessary to identify areas of maximum intensity.

Along squall lines (multiple cells or clusters of cells in a line), individual cells may be in different stages of development. Areas between closely spaced, intense targets may contain developing clouds not having enough moisture to produce a

return. However, these areas could have strong updrafts or downdrafts. Targets showing wide areas of green are generally precipitation without severe turbulence.

Irregularities in the target return may also indicate turbulence, appearing as “hooks,” “fingers,” or “scalloped” edges. These irregularities may be present in green areas with no yellow, red, or magenta areas and should be treated as highly dangerous areas. Avoid these areas as if they were red or magenta areas.

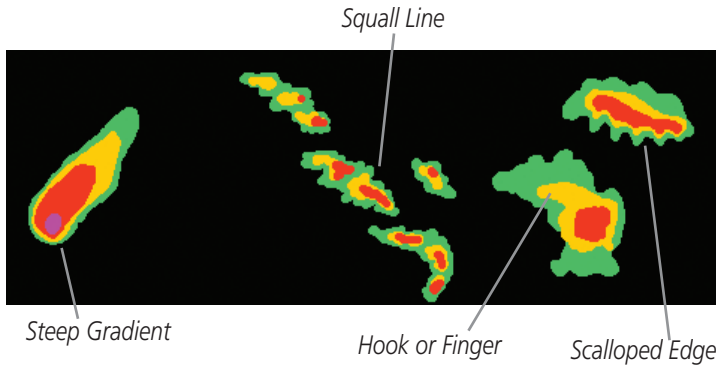

Figure 12-56 Cell Irregularities

Thunderstorm development is rapid. A course may become blocked within a short time. When displaying shorter ranges, periodically select a longer range to see if problems are developing further out. That can help prevent getting trapped in a “blind alley” or an area that is closed at one end by convective weather.

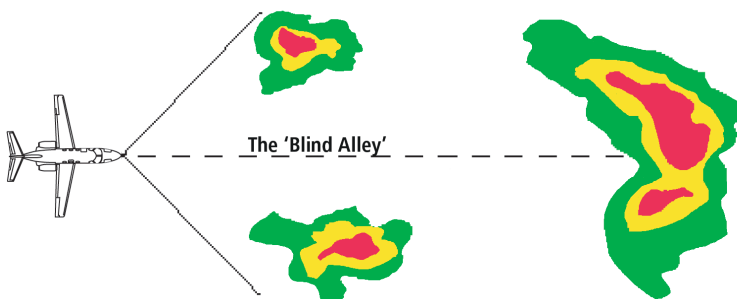

Figure 12-57 The “Blind Alley” Overhead View

In areas of multiple heavy cells, use the Vertical Scan feature along with antenna tilt management to examine the areas. Remember to avoid shadowed areas behind targets.

- Foreword
- Getting Started
- Audio & Xpdr Ctrl
- Com/Nav
- FPL
- Direct-To
- Proc
- Charts
- Wpt Info
- Map
- Traffic
- Terrain
- Weather**
- Nearest
- Services/Music
- Utilities
- System
- Messages
- Symbols
- Appendix

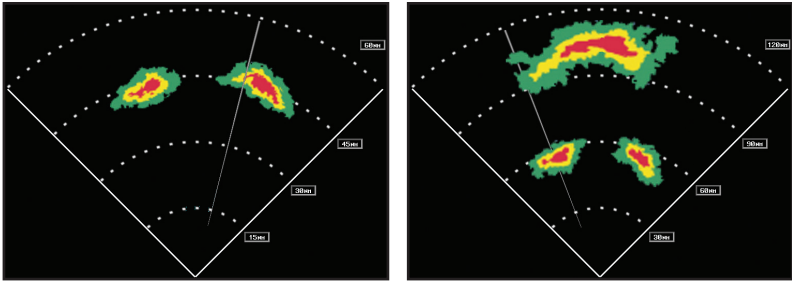

Figure 12-58 The “Blind Alley” Vertical Scan

12.3.5.3 Tornadoes

There is no conclusive radar target return characteristics which will identify a tornado, however, tornadoes may be present if the following characteristics are observed:

- A narrow, finger-like portion, as shown on the previous page, extends and, in a short time, curls into a hook and closes on itself.
- A “hook” which may be in the general shape of the numeral “6,” especially if bright and projecting from the southwest quadrant (northeast quadrant in the southern hemisphere) of a major thunderstorm.
- V-shaped notches.
- Doughnut shapes.

These shapes do not always indicate tornadoes, nor are tornado returns limited to these characteristics. Confirmed radar observations of tornadoes most often have not shown shapes different from those of a normal thunderstorm display.

12.3.5.4 Hail

Hail results from updrafts carrying water high enough to freeze. Therefore, the higher the top of a thunderstorm, the greater the probability that it contains hail. Vertically scanning the target return can give the radar top of a thunderstorm that contains hail. Radar top is the top of a storm cell *as detected by radar*. It is not the actual top, or true top of the storm. The actual top of a storm cell is seen with the eyes in clear air and may be much higher than the radar top. The actual top does not indicate the top of the hazardous area.

Hail can fall below the minimum reflectivity threshold for radar detection. It can have a film of water on its surface, making its reflective characteristics similar to a very large water droplet. Because of this film of water, and because hail stones usually are larger than water droplets, thunderstorms with large amounts of wet hail return stronger signals than those with rain. Some hail shafts are extremely narrow (100 yards or less) and make poor radar targets. In the upper regions of a cell where ice particles are “dry” (no liquid coating), target returns are less intense.

Hail shafts are associated with the same radar target return characteristics as tornadoes. U-shaped cloud edges 3 to 7 miles across can also indicate hail. These target returns appear quite suddenly along any edge of the cell outline. They also change in intensity and shape in a matter of seconds, making vigilant monitoring essential.

- Foreword
- Getting Started
- Audio & Xpdr Ctrl
- Com/Nav
- FPL
- Direct-To
- Proc
- Charts
- Wpt Info
- Map
- Traffic
- Terrain
- Weather**
- Nearest
- Services/ Music
- Utilities
- System
- Messages
- Symbols
- Appendix

12.4 GWX Radar Operation in Weather Mode



WARNING: Begin transmitting only when it is safe to do so. When transmitting while the aircraft is on the ground, no personnel or objects should be within 11 feet of the antenna.



CAUTION: In Standby mode, the antenna is parked at the center line. It is always a good idea to put the radar in Standby mode before taxiing the aircraft to prevent the antenna from bouncing on the bottom stop and possibly causing damage to the radar assembly.

When the weather radar system is in the Weather or Ground Map mode, the system automatically switches to Standby mode on landing.

The GWX 68 synchronizes the controls from all connected displays. All other GWX radars take commands from each display independently and perform a separate sweep for each.

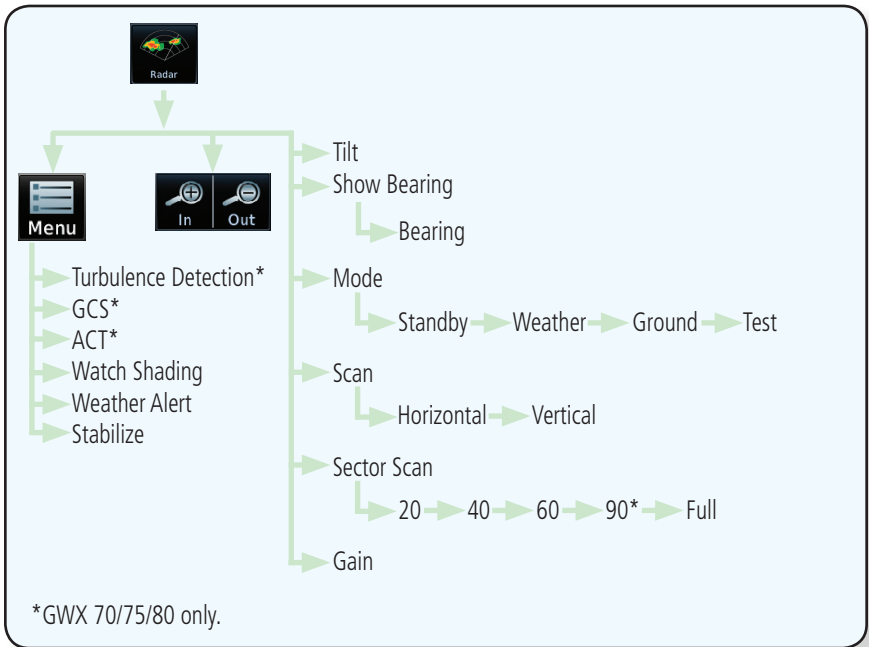

Figure 12-59 Weather Radar Functional Diagram

12.4.1 Viewing Weather on the Weather Radar Page

- From the Home page, touch **Weather** and then **Radar** (if necessary).

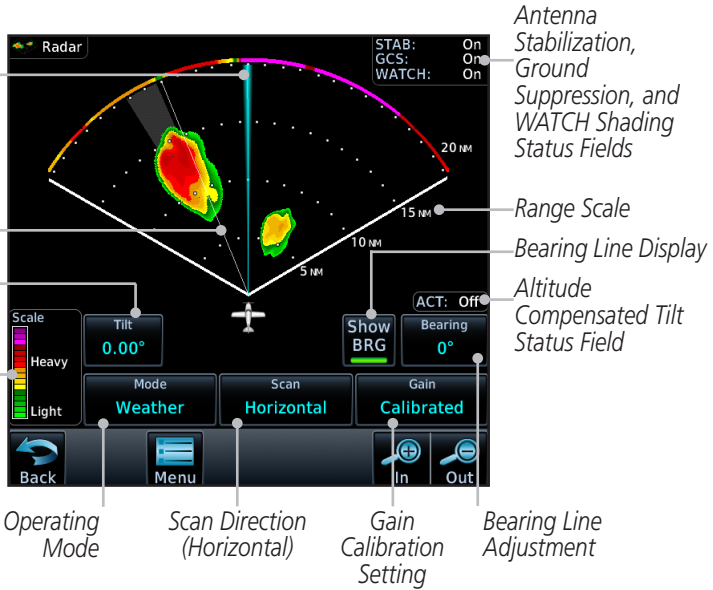

Figure 12-60 Weather Radar Page (Horizontal Scan)

- Touch the **MODE** key and then touch the function desired.
- The color-coded precipitation scale is shown on the left side of the display. A table describing the precipitation intensity levels is in section 12.3.5.1.

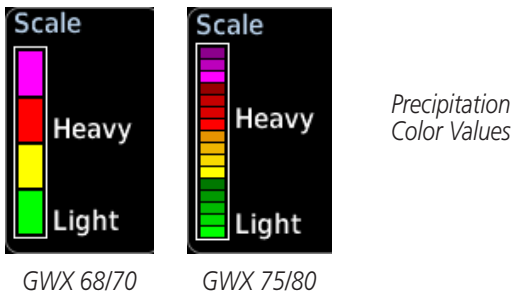

Figure 12-61 Weather Radar Precipitation Scale

- Touch the **IN** and **OUT** keys to select the desired range. Touch the desired keys to set any required values as described below.



12.4.2 Weather Radar Modes

Selecting Ground, Weather, or Test mode initiates a warm-up period (a countdown timer displays on the screen). The selected mode is available once warm-up is complete.

Mode
Off

1. While on the ground, touch **MODE**.

Mode
Standby

2. In the Weather Radar Mode window, touch **STANDBY**.

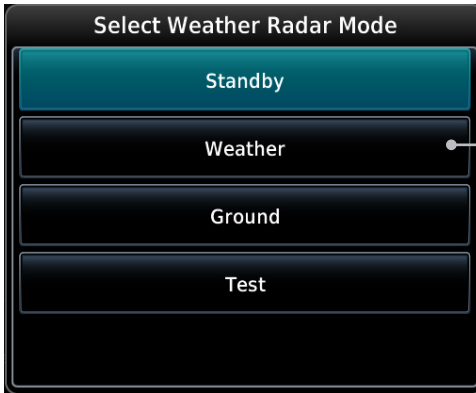

Figure 12-62 Weather Radar Mode Selection

Mode
Weather

3. Touch **MODE** and select Weather, Ground, or Test. A caution window is displayed.



Figure 12-63 Caution for Radar Activation Confirmation

OK

4. Touch **OK** to acknowledge the selected mode will be activated.

If Weather or Ground is selected, a warm-up period is initiated (countdown is displayed on the screen). After the warm-up is complete, the radar begins transmitting.

12.4.3 Vertically Scanning a Storm Cell

When vertically scanning with stabilization ON, the actual physical area that the radar is sweeping may not match the vertical scan display. This occurs whenever the aircraft pitch is not at 0 degrees. To compensate for this, the vertical display will “erase” the portion of the vertical display that is no longer being scanned. It will appear that the vertical sweep “wraps around” when reaching the end of the GTN vertical display. The radar is simply “erasing” the portion of the vertical display that is not currently being scanned.



NOTE: Vertical scanning of a storm cell should be done with the aircraft wings level to avoid constant adjustment of the Bearing Line.

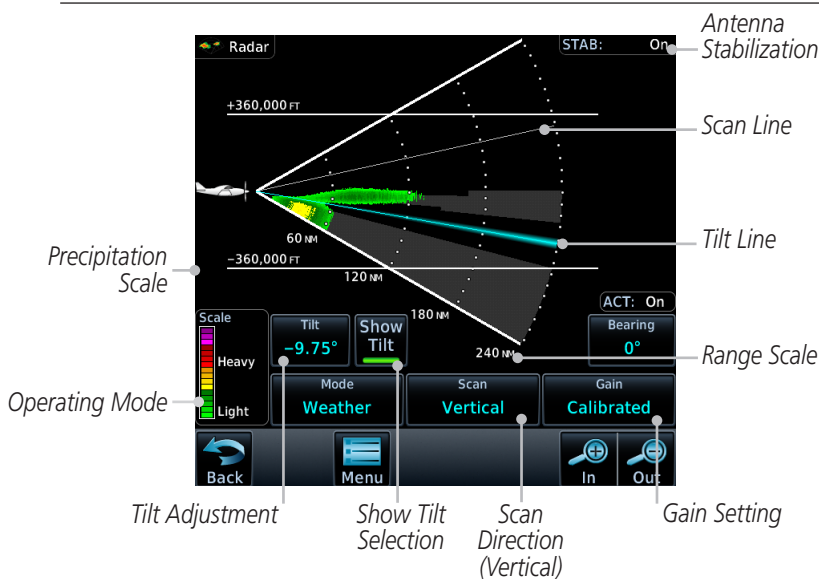

Figure 12-64 Weather Radar Page (Vertical Scan)

12.4.4 Adjusting the Antenna Tilt Angle

In order to make an accurate interpretation of a storm cell, the radar beam should be pointed at the wet part of the weather cell to record the proper rainfall intensity (color level). The ideal aiming point is just below the freezing level of the storm. The best way to find this point is to use the Vertical Scan feature. The antenna tilt angle can be centered on the strongest return area in the vertical scan to get a more accurate view of the coverage and intensity of the target in the horizontal scan.



1. While viewing the WX Radar page, touch the **TILT** key. An adjustment window will be displayed.

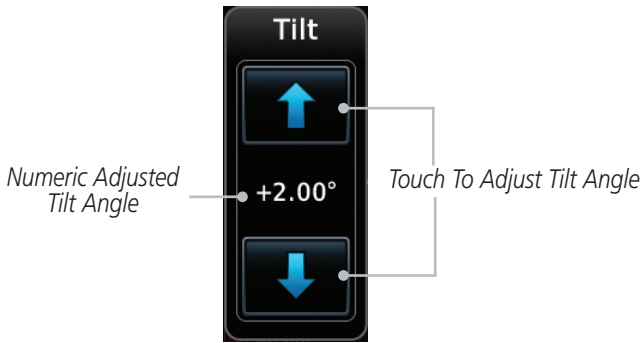

Figure 12-65 Adjusting Tilt



2. Touch the **Up and Down Arrow** keys to adjust the Tilt. The range is DN 15° to UP 15°.



3. Touch **Back** to save the values and return to the Radar display.

12.4.5 Adjusting the Bearing Line



1. Touch the **SHOW BRG** key. This displays the Bearing Line in Horizontal Scanning mode.
2. To adjust the Bearing Line, touch the **BEARING** key. An adjustment window will be displayed.

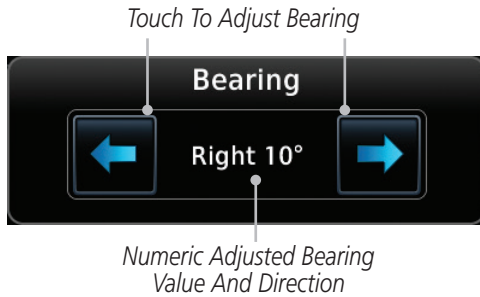

Figure 12-66 Bearing Line Adjustment

3. Touch the Bearing Adjustment arrow keys to change the gain.
4. Touch **Back** to save the values and return to the Radar display.



12.4.6 Adjusting Gain

Gain is used to adjust the sensitivity of the radar receiver. It can be used to adjust the characteristics of the returns from the surface.



WARNING: Changing the gain in weather mode will cause precipitation intensity to be displayed as a color not representative of the true intensity. Remember to return the gain setting to "Calibrated" for viewing the actual intensity of precipitation.

Set to Calibrated

1. While viewing the WX Radar page, touch the **GAIN** key. The Gain Adjustment Bar will be displayed.

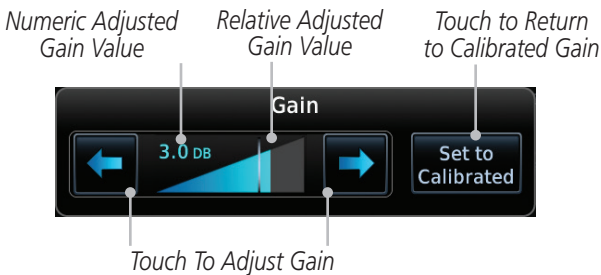

Figure 12-67 Gain Adjustment



2. Touch the Gain Adjustment arrow keys to change the gain.



3. Touch **Back** to save the values and return to the Radar display.

Restore Calibrated Gain



1. While viewing the WX Radar page, touch **GAIN** to display the Gain adjustment window.



2. Touch the **SET TO CALIBRATED** key. This will restore the calibrated gain.

12.4.7 Weather Radar Menu



Touching **Menu** opens the Weather Radar menu. With the exception of Sector Scan, all selections are on/off only.

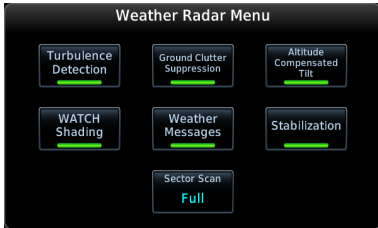

GWX 70

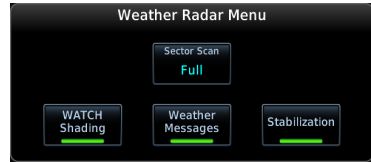

GWX 68

Figure 12-68 Weather Radar Menu Selections



NOTE: In software prior to v6.50, Ground Clutter Suppression (GCS) and Turbulence Detection are only supported for 12" or larger RADAR antennas. Turbulence Detection is only supported out to a range of 40 NM and is disabled at display ranges greater than 160 NM.

12.4.7.1 Weather Attenuated Color Highlight (WATCH™)

While in horizontal scan mode, this feature can be used as a tool to determine areas of possible inaccuracies in displayed intensity due to weakening of the radar energy. This weakening is known as “attenuation.” The radar energy weakens as it passes through areas of intense precipitation, large areas of lesser precipitation, and distance. Issues with the radome will also attenuate the radar energy. All these factors have an effect on the return intensity. The more energy that dissipates, the lesser the displayed intensity of the return. Accuracy of the displayed intensity of returns located in the shaded areas are suspect. Make maneuvering decisions with this information in mind. Proper antenna tilt management should still be employed to determine the extent of attenuation in a shaded area.



1. While viewing the Weather Radar menu, touch **WATCH Shading** to toggle WATCH Shading.

To deactivate WATCH mode, touch the key again.

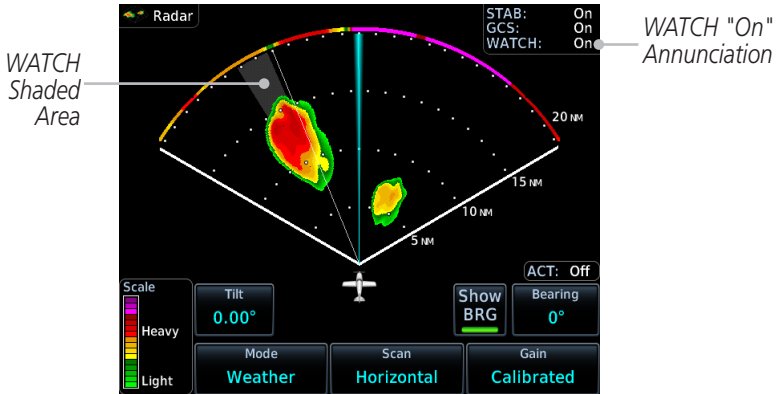

Figure 12-69 Horizontal Scan with WATCH

12.4.7.2 Weather Messages

The weather alert feature may be used to indicate the presence of heavy precipitation beyond the currently displayed range and 80 to 320 NM from the aircraft's present position. Weather alert targets appear as colored bands along the outer range ring at the approximate azimuth of the detected returns.

If a weather alert is detected within $\pm 10^\circ$ of the aircraft heading, a message will be displayed in the Messages page. Touch the **MSG** key to view messages.

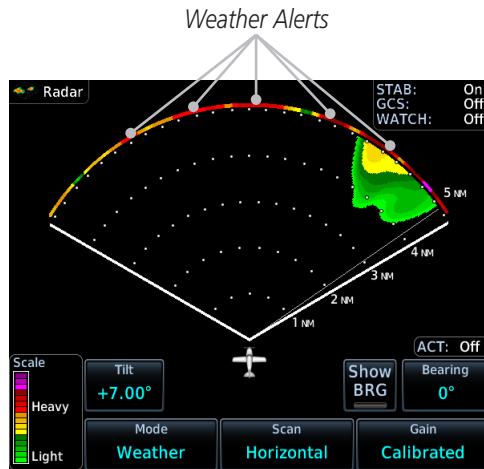

Figure 12-70 Weather Alert Display

If the antenna tilt is adjusted too low, a weather message can be generated by ground returns. To avoid this issue, set the display range to less than 80 NM in the terminal area.

Foreword
Getting Started
Audio & Xpdr Ctrl
Com/Nav
FPL
Direct-To
Proc
Charts
Wpt Info
Map
Traffic
Terrain
Weather
Nearest
Services/ Music
Utilities
System
Messages
Symbols
Appendix
Index



1. While viewing the Weather Radar menu, touch **Weather Alert** to toggle weather alerts.
2. To deactivate weather alerts, repeat sequence.

12.4.7.3 Antenna Stabilization

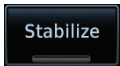

1. While viewing the Weather Radar menu, touch **Stabilize** to toggle Antenna Stabilization.
2. To deactivate Antenna Stabilization, repeat sequence. The current stabilization condition is shown in the top right of the weather radar display.

12.4.7.4 Altitude Compensated Tilt (GWX 70/75/80 Only)

Altitude Compensated Tilt (ACT) automatically adjusts the tilt to compensate for altitude changes as you climb or descend.



1. While viewing the Weather Radar menu, touch **ACT** to toggle ACT.
2. To deactivate ACT, repeat sequence.

12.4.7.5 Turbulence Detection (GWX 70/75/80 Only)

Turbulence Detection activates a feature that detects and displays severe turbulence. Turbulence Detection is inactive at ranges greater than 160 NM. If Turbulence Detection is enabled and available, Turbulence Detection will be reported as Inactive in any of the following conditions:

- Scan orientation is not Horizontal
- Scan range is greater than 160 NM
- Radar mode is not Weather

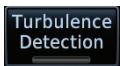

1. While viewing the Weather Radar menu, touch **Turbulence Detection** to toggle Turbulence Detection.
2. To deactivate Turbulence Detection, repeat sequence.

12.4.7.6 Ground Clutter Suppression (GWX 70 Only)

Ground Clutter Suppression (GCS) reduces the amount of returns as a result of highly reflective objects on the ground, such as buildings or cities, while maintaining the intensity and size of weather returns.



1. While viewing the Weather Radar menu, touch **GCS** to toggle Ground Clutter Suppression.
2. To deactivate Ground Clutter Suppression, repeat sequence.

12.4.7.7 Sector Scan

Adjusting the Sector Scan reduces the scan angle from Full in increments of $\pm 20^\circ$, $\pm 40^\circ$, and $\pm 60^\circ$ in horizontal or vertical scanning.

1. While viewing the Weather Radar menu, touch **Sector Scan** to display the Sector Scan Mode window.

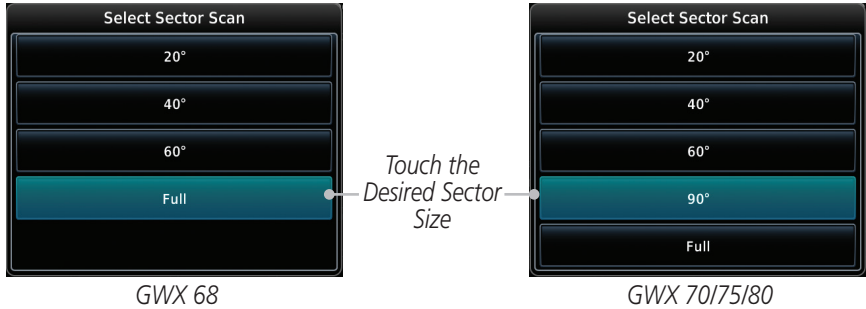

Figure 12-71 Sector Scan Mode

2. Touch the desired mode. After selection, you are returned to the Weather Radar menu.
3. Touch **Back** to exit the menu.

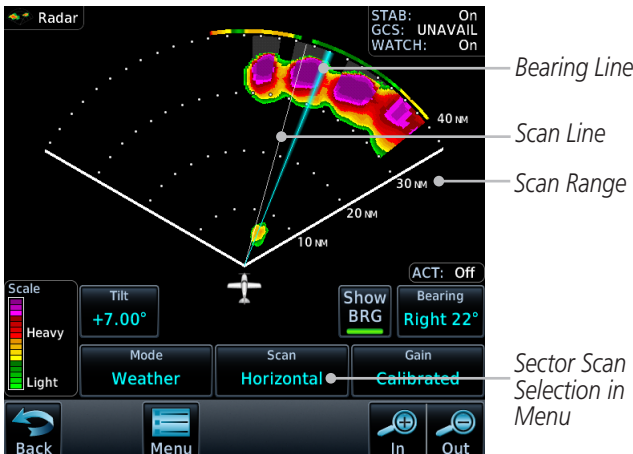

Figure 12-72 Selected Sector Scan Range

12.5 Connex Weather

Connex Weather is an optional feature available with the Iridium® satellite system that is interfaced through the optional Garmin GSR 56. Connex Weather may be viewed in the Weather and Map functions. The Weather pages may be oriented to either Track Up, Heading, or North Up. Both Connex and XM Weather may be installed and selected individually.

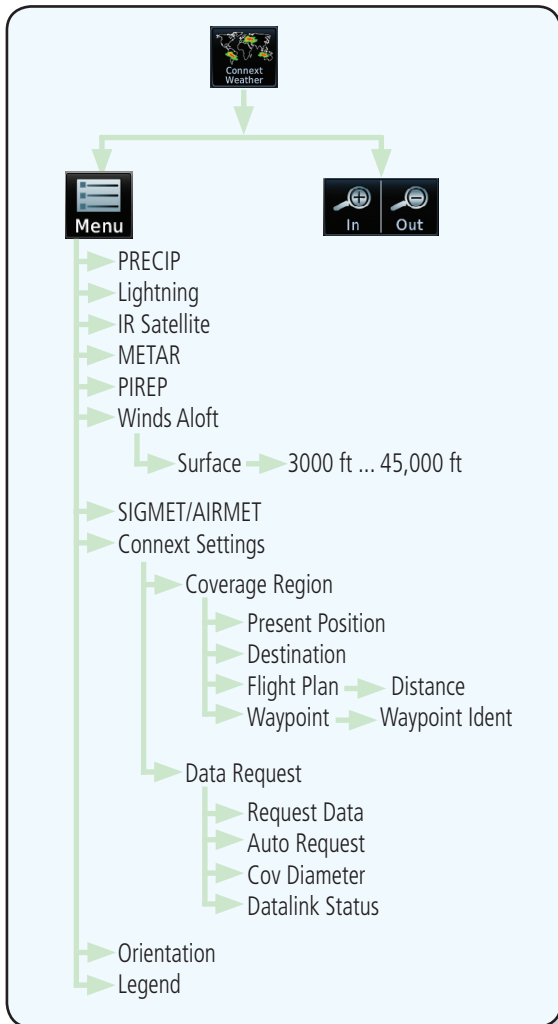

Figure 12-73 Connex Weather Functional Diagram

Foreword
Getting Started
Audio & Xpdr Ctrl
Com/Nav
FPL
Direct-To
Proc
Charts
Wpt Info
Map
Traffic
Terrain
Weather
Nearest
Services/Music
Utilities
System
Messages
Symbols
Appendix

Connex Weather coverage is available throughout most of Europe, Canada and the U.S. Additional radar coverage areas are added continuously. For the latest radar coverage information, visit: <https://fly.garmin.com/fly-garmin/connex/worldwide-weather/>

Various world-wide weather subscription package options provide weather reporting for most of Europe, Canada, Australia, and the U.S.

12.5.1 Using Connex Satellite Weather Products



NOTE: A system can be configured for multiple weather products, but only one may be selected for viewing in the Weather or map pages at a given time.

When a weather product is active on the Weather Data Link Page or the Navigation Map Page, the age of the data is displayed on the screen. The age of the product is based on the time difference between when the data was assembled on the ground and the current GPS time. Weather products are refreshed at selectable intervals.

Weather products expire at intervals based on each product. When the data expires, it is removed from the display. This ensures that the displayed data is consistent with what is currently being broadcast by Connex Satellite Radio services. If more than half of the expiration time has elapsed from the time the data is received, the color of the product age displayed changes to yellow.

Foreword

Getting Started

Audio & Xpdr Ctrl

Com/Nav

FPL

Direct-To

Proc

Charts

Wpt Info

Map

Traffic

Terrain

Weather

Nearest

Services/
Music

Utilities

System

Messages

Symbols

Appendix

12.5.2 Connex Weather Menu

The Connex Weather page is customized by selecting options from the Connex Weather and the Connex Settings Menus. The Connex Weather Menu options include choices for Weather Setup and displaying selected weather products. The Connex Settings Menu makes settings for the Coverage Region and Data Request frequency.



1. While viewing the Connex Weather page, touch the **MENU** key to display the Connex Weather Menu. Touch the desired keys to toggle the weather product.

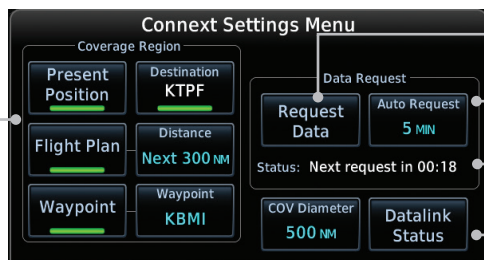

Figure 12-74 Connex Weather Menu



2. Touch the **Connex Settings** key to make detailed settings for the Connex Weather display.

12.5.3 Connex Settings



Coverage Region Settings

Touch To Manually Request Data

Auto Request Setting

Time To Next Data Request

Datalink Status

Figure 12-75 Connex Settings Menu

12.5.3.1 Connex Data Request

It is necessary to request the downloading of weather products. Requests can be sent manually or set to automatically update at a selected rate. The Connex weather data may be updated at any time regardless of the automatic update timing by selecting a Manual Request. When multiple requests are made, some products are merged with the old data (SIGMETs/AIRMETs, TAFs, TFRs, and METARs), but the old data of other products is discarded.

Request Data

1. While viewing the Connex Settings Menu, touch the **Request Data** key to manually request data.

Auto Request
Off

2. Touch the **Auto Request** key to set the Auto Request Period.



NOTE: The Auto Request function is only enabled if the GTN is connected directly to the GSR 56 (software v6.30 and later).



Figure 12-76 Select Auto Request Period

Cancel Request

3. Touch the **Cancel Request** key to cancel a request in progress.



Figure 12-77 Cancelling A Request

12.5.3.2 Connex Data Request Coverage Region

Present Position Data Request



Touch the **Present Position** key to request that weather information will be shown around your present position.

Destination Connex Data Request



Touch the **Destination** key to request that weather information will be shown around the destination waypoint in the flight plan.

Flight Plan Data Request

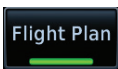

Touch the **Flight Plan** key to request that weather information will be shown around the active flight plan.

Flight Plan Distance Data Request



Touch the **Distance** key to request that weather information will be shown for the selected distance along the active flight plan.

Waypoint Connex Data Request



1. Touch the **Waypoint** key to request that weather information will be shown around the selected waypoint.



2. Select the waypoint and then press **ENT**.

Diameter/Route Width Connex Data Request



After selecting a coverage option in the previous section, select the desired **Diameter** and then press **ENT**.

12.5.3.3 Connex Weather Map Orientation



1. While viewing the Connex Weather Menu, touch the **Orientation** key.

2. Touch the orientation choices of North Up, Track Up, and Heading Up and to accept the displayed value and return to the Connex Weather Menu.

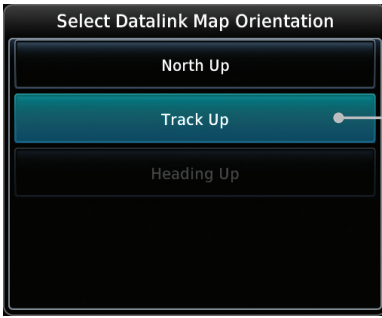

Touch To Select Map Orientation

Figure 12-78 Connex Weather Map Orientation

Foreword
Getting Started
Audio & Xpdr Ctrl
Com/Nav
FPL

Direct-To

12.5.4 Register with Connex

To access Connex Weather, visit flyGarmin.com and create a Connex Satellite Services account. Be ready to provide the GTN system ID, airframe information (model, tail number), and Iridium serial number. Garmin will issue an access code for entry on the Connex Registration page. If access code and system ID are correct, the airframe registration details will display.

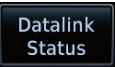

1. While viewing Connex Settings Menu, touch the **Datalink Status** key.

Proc
Charts
Wpt Info
Map



Figure 12-79 GSR 56 Status

Traffic
Terrain
Weather
Nearest
Services/Music
Utilities
System

Messages
Symbols
Appendix

- Foreword
- Getting Started
- Audio & Xpdr Ctrl
- Com/Nav
- FPL
- Direct-To
- Proc
- Charts
- Wpt Info
- Map
- Traffic
- Terrain
- Weather
- Nearest
- Services/ Music
- Utilities
- System
- Messages
- Symbols
- Appendix

Connex
Registration

2. Touch the **Connex Registration** key to display the Connex Registration page.

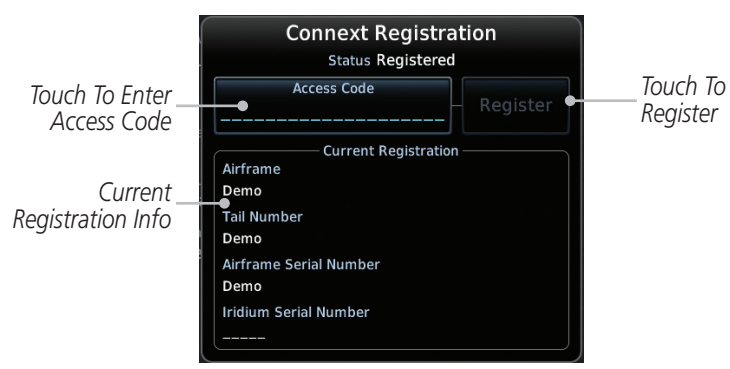

Figure 12-80 Connex Registration Page

←
Enter

3. Touch the **Access Code** key to enter the appropriate code and then touch the **Enter** key.

Register

4. Touch the **Register** key to complete the process. The GTN will contact the Connex servers using the GSR 56 transceiver.

Deactivate Unit Registration With Connex

Registration of the GTN unit with Connex can be deactivated so that the unit can no longer make requests to Connex. This does not cancel the subscription.

1. While viewing the Connex Registration page, touch the Access Code field and enter an invalid access code to deactivate the Connex registration.
2. Any weather requests will now fail and the system will no longer be linked to the Connex account.

12.5.5 Connex Weather Product Age

The weather product refresh rate represents the interval at which Connex Satellites broadcast new signals that may or may not contain new weather data. It does not represent the rate at which weather data is updated or new content is received by the Data Link Receiver. Weather data is refreshed at intervals that are defined and controlled by Connex and its data vendors.



WARNING: Do not use the indicated data link weather product age to determine the age of the weather information shown by the data link weather product. Due to time delays inherent in gathering and processing weather data for data link transmission, the weather information shown by the data link weather product may be significantly older than the indicated weather product age.

12.5.6 TFRs

Temporary Flight Restrictions (TFRs) provide detailed information for local short term restrictions.



Figure 12-81 Connex TFR Legend



1. Touch a TFR symbol on the Weather page to view details.

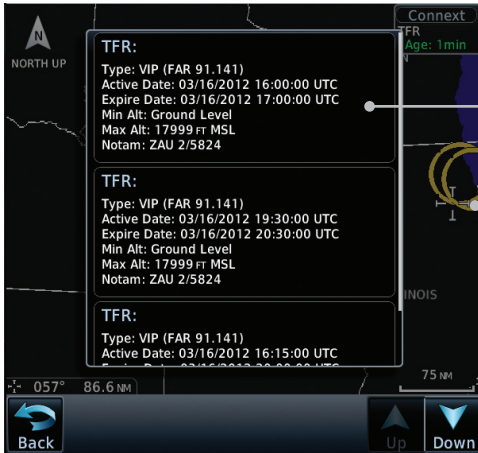

TFR Detail

Touch TFR Symbol To View Details

Figure 12-82 Connex TFR Detail



2. Touch the **Back** key to return to the Weather display.

12.5.7 Precipitation (PRECIP) Data

Graphical data is overlaid on the map indicating the rainfall detected by ground based radar for a specific area. The colors indicating increasing levels of rainfall progresses from light green for light rainfall to red for heavy rainfall. Review the Limitations section in the front of this guide for the limitations that apply to the Connex data. Rainfall data is color coded as follows:

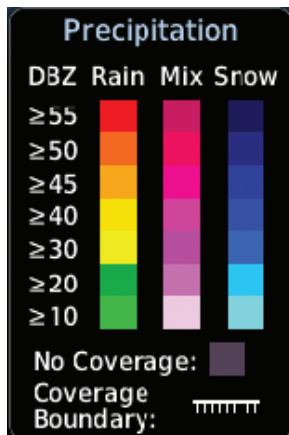

Figure 12-83 Connex PRECIP Weather Map Display and Legend

The "No Coverage" color indicates that no data is available for that area, and rainfall in that area is unknown.

When weather data is received, the airborne system will display that data for 20 minutes. If no new data has been received for a given area, the rainfall will be removed after 20 minutes and the area will revert back to the "No Coverage" color.

The Connex Weather Function is based on a ground-to-air data link and requires that the appropriate ground systems are broadcasting weather data and the aircraft is within reception range of the Ground Broadcast Transceiver (GBT).

12.5.7.1 Animating Precipitation Data



NOTE: *Animated Precipitation functionality is available in software v6.00 and later.*

When Precipitation Data is enabled for display and more than two Precipitation images have been received by the GTN, the Precipitation display can be animated on the Connex Weather page. As new Precipitation images are received, the GTN will automatically store them for future animation. The GTN can animate up to six Precipitation images from oldest to newest, showing each for one second and the newest for two seconds.



1. While viewing the Connex Weather page with Precipitation enabled for display, press the **Play PRCP** key to start the Precipitation animation.



2. Touch the **Stop PRCP** key to stop the Precipitation animation. The animation will also stop when leaving the page or turning off Precipitation on the Connex weather page.

12.5.8 Lightning

Lightning data shows the approximate location of cloud-to-ground lightning strikes. A strike icon represents a strike that has occurred within a two kilometer (1.08 NM) region. The exact location of the lightning strike is not displayed. Only cloud to ground strikes are reported in the US and extreme southern Canada (cloud to cloud strikes are not reported).

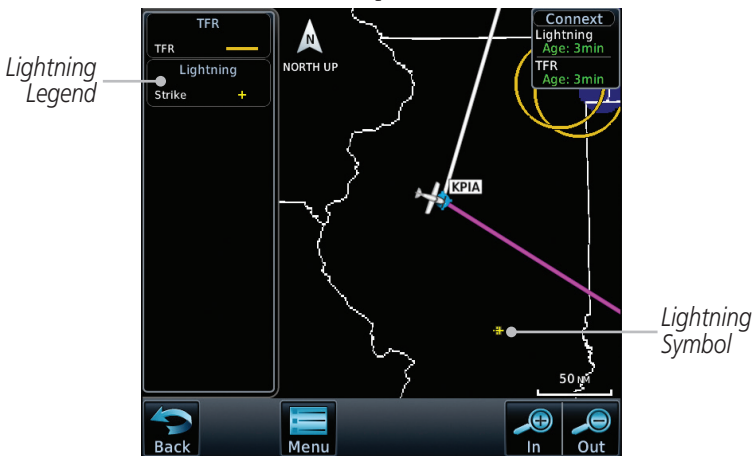

Figure 12-84 Connex Data Link Lightning and Legend

12.5.9 Infrared Satellite Data

Infrared Satellite data is available over North America and Europe and depicts cloud top temperatures from satellite imagery. Brighter cloud top colors indicate cooler temperatures occurring at higher altitudes. Information is updated every half hour.

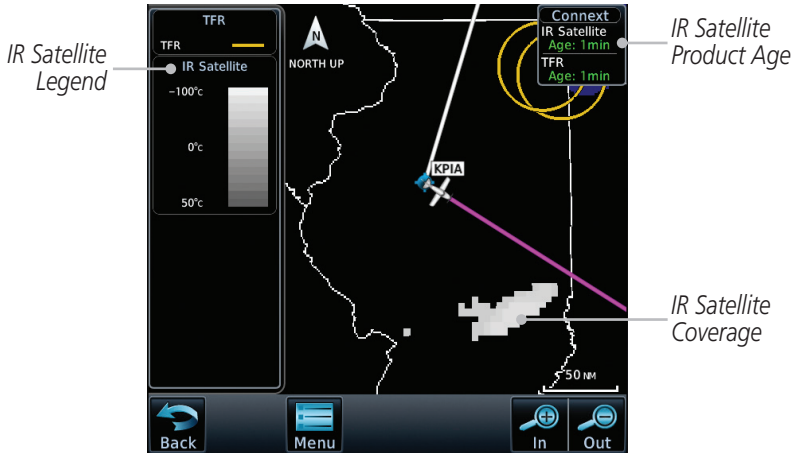

Figure 12-85 Connect Infrared Satellite Data Map Display and Legend

12.5.10 METARs



NOTE: Atmospheric pressure reported for METARs is given in hectopascals (hPa), except in the United States, where it is reported in inches of mercury (in Hg). Temperatures are reported in Celsius.



NOTE: METAR information is only displayed within the installed aviation database service area.

METAR (METeoro logical Aerodrome Report), known as an Aviation Routine Weather Report, is the standard format for current weather observations. METARs are generally updated hourly, but some sites are more frequent. Special updates are done as conditions warrant. METARs typically contain information about the temperature, dew point, wind, precipitation, cloud cover, cloud heights, visibility, and barometric pressure. They can also contain information on precipitation amounts, lightning, and other critical data. METARs are shown as colored flags at airports that provide them.





METAR Symbol	Description
	VFR (ceiling greater than 3000 ft. AGL and visibility greater than five miles)
	Marginal VFR (ceiling 1000–3000 ft. AGL and/or visibility three to five miles)
	IFR (ceiling 500 to below 1000 ft. AGL and/or visibility one mile to less than three miles)
	Low IFR (ceiling below 500 ft. AGL or visibility less than one mile)
	Unknown

Table 12-30 METAR Symbols

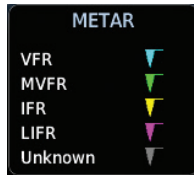
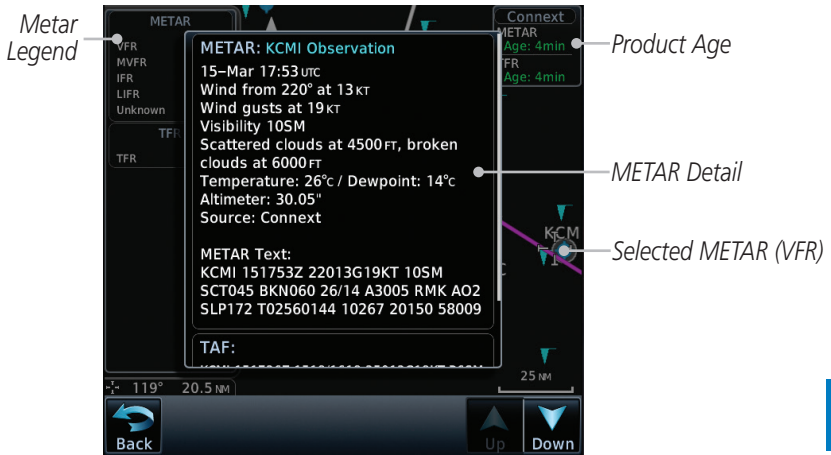

Figure 12-86 Connex Weather - Graphic METARs and Legend

12.5.11 PIREPs

Pilot Weather Reports (PIREPs) provide timely weather information for a particular route of flight. When significant weather conditions are reported or forecast, Air Traffic Control (ATC) facilities are required to solicit PIREPs. A PIREP may contain non-forecast adverse weather conditions, such as low in-flight visibility, icing conditions, wind shear, and turbulence. PIREPs are issued as either Routine (UA) or Urgent (UUA).



Figure 12-87 Connex Weather - PIREPs

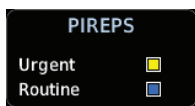

Figure 12-88 Connex Weather - PIREPs Legend

12.5.12 Winds Aloft

Winds Aloft data shows the forecast wind speed and direction at the surface and at selected altitudes. Altitudes can be selected in 3000 foot increments from the surface up to 42,000 feet MSL. Pressing the **WX Aloft ALT +** or **-** soft keys steps down or up in 3,000 foot increments.

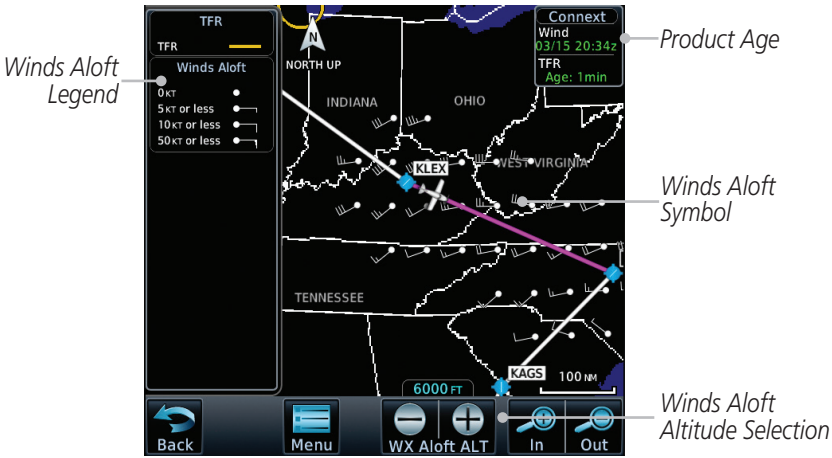

Figure 12-89 Connex Weather - Winds Aloft



Figure 12-90 Connex Weather - Winds Aloft Legend

Winds Aloft Altitude

The Winds Aloft Altitude option allows you to select the altitude for the Winds Aloft weather product. Altitude can be selected in 3,000 foot increments from the surface up to 42,000 feet MSL.

Pressing the **WX Aloft ALT +** or **-** soft keys steps down or up in 3,000 foot increments. In the figure shown above, 6,000 feet is selected and Winds Aloft data is shown for winds reported at an altitude of 6,000 feet.

- Foreword
- Getting Started
- Audio & Xpdr Ctrl
- Com/Nav
- FPL
- Direct-To
- Proc
- Charts
- Wpt Info
- Map
- Traffic
- Terrain
- Weather
- Nearest
- Services/Music
- Utilities
- System
- Messages
- Symbols
- Appendix

12.5.13 SIGMETs and AIRMETS

SIGMETs (SIGNificant METeorological Information) and AIRMETS (AIRmen's METeorological Information) are broadcast for potentially hazardous weather considered of importance to aircraft. A Convective SIGMET is issued for hazardous convective weather. A localized SIGMET is a significant weather condition occurring at a localized geographical position.



Figure 12-91 Connex Weather Page - AIRMETS/SIGMETs

When enabled, SIGMET/AIRMETS advise the pilot of potentially hazardous weather. SIGMETs are directed to all aircraft. AIRMETS are intended for light aircraft. SIGMET/AIRMET data covers icing, turbulence, dust, and volcanic ash as issued by the National Weather Service. The update rate is selected in the Connex Settings Menu.



Figure 12-92 Connex Weather - AIRMETS/SIGMETs Detail and Legend

When enabled, the following AIRMETS are available for display:

- Icing
- Turbulence
- IFR conditions
- Mountain obscuration
- Surface winds

12.6 FIS-B Weather



NOTE: *FIS-B information is to be used for pilot planning decisions and pilot near-term decisions focused on avoiding areas of inclement weather that are beyond visual range or where poor visibility precludes visual acquisition of inclement weather. FIS-B weather and NAS status information may be used as follows:*

(a) To promote pilot awareness of own ship location with respect to reported weather, including hazardous meteorological conditions, NAS status indicators, and enhance pilot planning decisions and pilot near-term decision-making.

(b) To cue the pilot to communicate with the Air Traffic Control controller, Flight Service Station specialist, operator dispatch, or airline operations control center for general and mission critical meteorological information, NAS status conditions, or both.

FIS-B information, including, weather information, NOTAMs, and TFR areas, are intended for the sole purpose of assisting in long- and near-term planning decision making. The system lacks sufficient resolution and updating capability necessary for aerial maneuvering associated with immediate decisions.

The Flight Information Services (FIS-B) function is capable of displaying text and graphic weather information with GDL 88 and GTX 345 installations. No subscription for FIS-B services is required.

The FIS-B Function is a graphic weather display capable of displaying graphical weather information on UAT equipped installations. Graphical data overlaid on the map indicates the rainfall detected by ground based radar for a specific area. Color transitions from light green (light rainfall) to magenta (heavy rainfall) represent an increase in precipitation. Review the Limitations section in the front of this guide for the limitations that apply to the FIS-B data.

Foreword

Getting Started

Audio & Xpdr Ctrl

Com/Nav

FPL

Direct-To

Proc

Charts

Wpt Info

Map

Traffic

Terrain

Weather

Nearest

Services/ Music

Utilities

System

Messages

Symbols

Appendix

Rainfall data is color coded as follows:

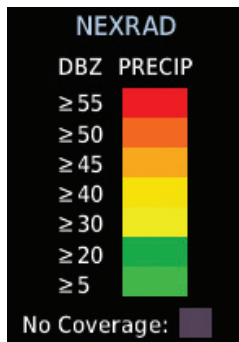

Figure 12-93 FIS-B Weather Precipitation Legend

Gray shaded areas indicate that data is not available or that no data has been received for a requested area. Gray shades may also indicate that the rainfall rate for a given area is undetermined.

The FIS-B Function is based on a ground-to-air data link and requires that the appropriate ground systems are broadcasting weather data and the aircraft is within reception range of the Ground Broadcast Transceiver (GBT).

- Foreword
- Getting Started
- Audio & Xpdr Ctrl
- Com/Nav
- FPL
- Direct-To
- Proc
- Charts
- Wpt Info
- Map
- Traffic
- Terrain
- Weather**
- Nearest
- Services/ Music
- Utilities
- System
- Messages
- Symbols
- Appendix
- Index

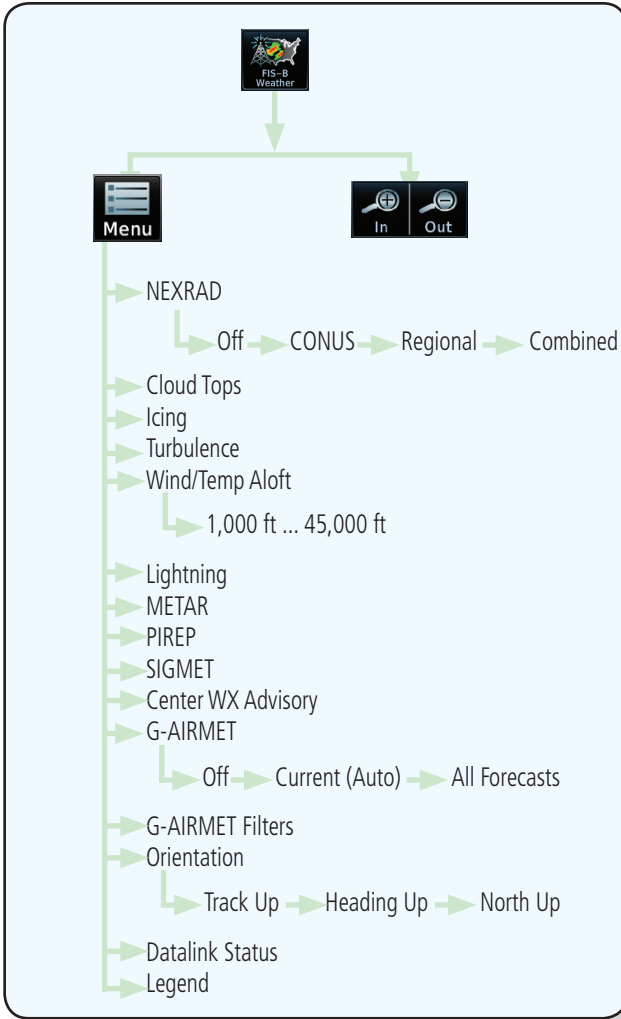

Figure 12-94 FIS-B Weather Functional Diagram



WARNING: Do not use the indicated data link weather product age to determine the age of the weather information shown by the data link weather product. Due to time delays inherent in gathering and processing weather data for data link transmission, the weather information shown by the data link weather product may be significantly older than the indicated weather product age.

12.6.1 FIS-B Operation

Weather data reception time is shown in the upper right corner of the screen. An indicated time shows if the aircraft is currently within reception coverage of a ground station with weather broadcast capabilities. The ground system determines the weather coverage area and extent of data that is transmitted by each ground station.

Due to similarities in depiction, the following FIS-B Weather products are mutually exclusive: NEXRAD, Cloud Tops, Icing, Turbulence, Winds and Temperatures Aloft, and Lightning.

1. From the Home page, touch the **Weather** key on the Home page and then touch the **FIS-B Weather** key (if necessary).



Weather Product Legends

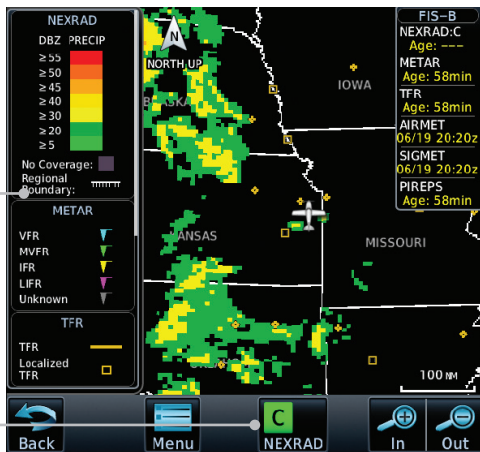

Age Of Selected Weather Products

NEXRAD Selection

Touch + or - To Select Map Range

Figure 12-95 FIS-B Weather Page (NEXRAD Key Shown)

2. While viewing the FIS-B weather page, touch the **Menu** key to configure the Data Link Weather page.



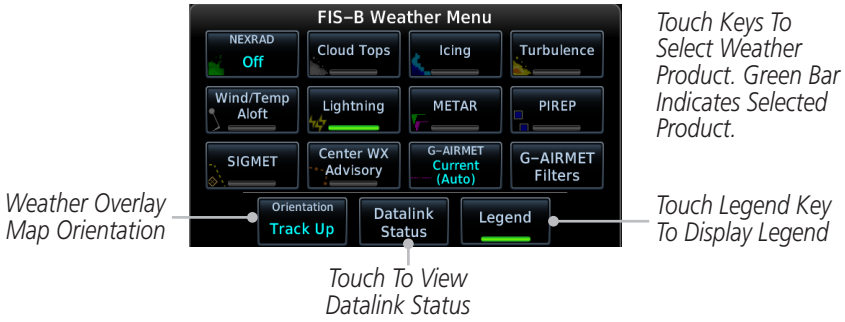

Touch Keys To Select Weather Product. Green Bar Indicates Selected Product.

Figure 12-96 FIS-B Weather Data Link Menu

- Once you selected what items you want to display, touch **BACK** to return to the FIS-B Weather page.



12.6.2 FIS-B NEXRAD



WARNING: Never use NEXRAD weather for maneuvering in, near, or around areas of hazardous weather. NEXRAD images are snapshots of past weather data. They are not safe for use as real time depictions of nearby weather activity.



Figure 12-97 FIS-B CONUS NEXRAD

NEXRAD weather radar displays a mosaic of precipitation data, colored according to reflectivity. Composite reflectivity images depict the highest radar energy received from multiple antenna tilt angles at various altitudes. Base reflectivity images depict radar returns from the lowest antenna tilt angle. Per AC 00-63A, FIS-B CONUS and Regional NEXRAD are composite reflectivity images.

The precipitation intensity level reflected by each pixel represents the highest level of composite radar reflectivity data sampled in that location.

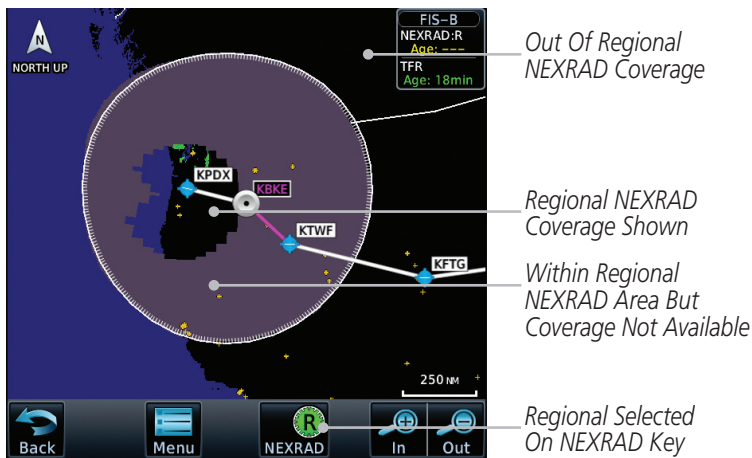

Figure 12-98 Regional NEXRAD

A clear understanding of ground-based Doppler weather radar capabilities will allow you to interpret the NEXRAD weather imagery in the safest way possible. The National Oceanic and Atmospheric Administration hosts a description of the technology on its website: https://www.weather.gov/jetstream/doppler_intro

12.6.2.1 Radar Data Animations



NOTE: *Animated NEXRAD functionality is available in software v6.00 and later.*



To depict trending weather movements over time, an animation function stitches the last three to six received radar images together in sequence, from oldest to newest, and replays them on a continuous loop.



Play and stop controls are active when three or more NEXRAD images are available for playback.

12.6.2.2 CONUS and Regional NEXRAD

To depict trending weather movements over time, an animation function stitches the last three to six received radar images together in sequence, from oldest to newest, and replays them on a continuous loop.

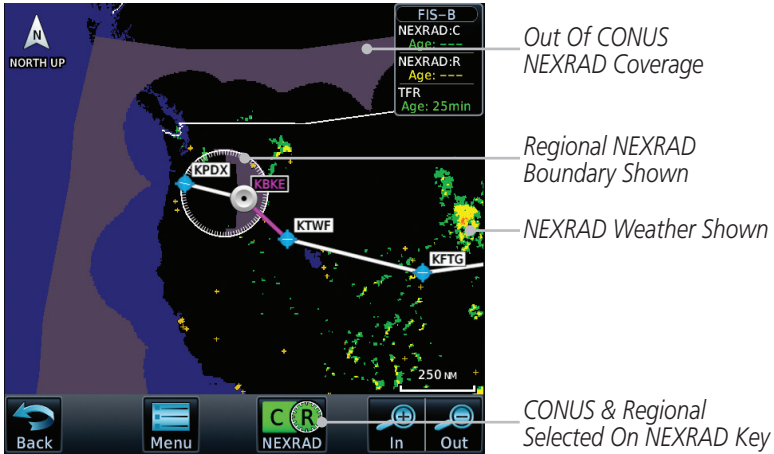

Figure 12-99 FIS-B CONUS & Regional NEXRAD Combined

Depending on the locations of received FIS-B ground stations, Regional NEXRAD coverage can extend as far as 250 nm around an aircraft's position. Aircraft flying at higher altitudes typically receive data from more ground stations than aircraft flying at low altitudes.

FIS-B NEXRAD does not differentiate between liquid and frozen precipitation types.

Source options are selectable from the weather setup menu or the NEXRAD key at the bottom left of the FIS-B Weather page. The key label changes to reflect the active source.



Type	Description
CONUS	<ul style="list-style-type: none"> • Large, low-resolution weather image for the entire continental U.S. • Pixels are 7.5 min (7.5 nm = 13.89 km) wide by 5 min (5 nm = 9.26 km) wide
Regional	<ul style="list-style-type: none"> • High-resolution weather image with limited range, centered around each broadcasting ground station • Pixels are 1.5 min (1.5 nm = 2.78 km) wide by 1 min (1 nm = 1.852 km) tall • Each weather pixel varies with latitude. Above 60° latitude, pixel block width doubles to 3 min/nm for regional maps
Combined	<ul style="list-style-type: none"> • Both CONUS and Regional NEXRAD images display simultaneously • White hash mark indicates regional boundary • Animation functionality not available

Table 12-31 FIS-B NEXRAD Types

12.6.2.3 NEXRAD Abnormalities

There are possible abnormalities regarding displayed NEXRAD images. Some, but not all, causes of abnormal displayed information include:

- Ground Clutter
- Strobes and spurious radar data
- Sun strobes, when the radar antenna points directly at the sun
- Military aircraft deploy metallic dust which can cause alterations in radar scans
- Interference from buildings or mountains, which may cause shadows
- Scheduled maintenance may put a radar off-line

Affected Areas

Any area in the continental United States (CONUS) or Alaska where the distance from ADS-B ground stations, or the combined effect of distance and low altitude, is sufficiently great may cause poor reception. To find the latest ground station coverage, visit www.faa.gov.

Reception will improve in some affected areas as the FAA completes the NextGen ADS-B ground station infrastructure. However, due to line-of-sight broadcast characteristics, operators with properly installed and functioning equipment may still receive incomplete FIS-B data when signal reception is limited by the distance from ground stations combined with a low altitude.

The example below displays an area where FIS-B data is degraded due to poor reception:



Figure 12-100 FIS-B Reception Unavailable



NOTE: No coverage areas are semi-transparent in software v6.60 and later.

Selecting NEXRAD in the FIS-B Weather Menu



1. While viewing the FIS-B weather page, touch the **Menu** key to select the NEXRAD choice.
2. Touch the **NEXRAD** key to select Off, Regional, CONUS, or Combined.

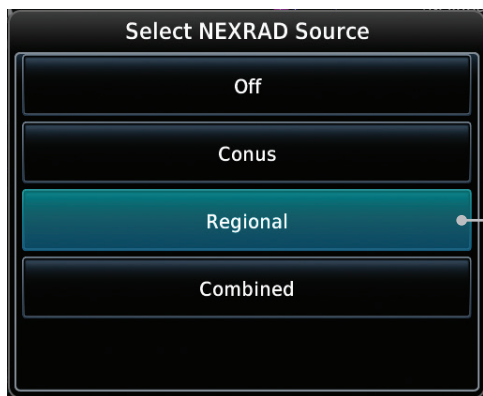

*Touch the Desired
NEXRAD Source*

Figure 12-101 NEXRAD Source Selection



3. Touch the **Back** key to return to the FIS-B Weather Menu.

- Foreword
- Getting Started
- Audio & Xpdr Ctrl
- Com/Nav
- FPL
- Direct-To
- Proc
- Charts
- Wpt Info
- Map
- Traffic
- Terrain
- Weather**
- Nearest
- Services/ Music
- Utilities
- System
- Messages
- Symbols
- Appendix

12.6.3 FIS-B TFRs

Temporary Flight Restrictions (TFRs) provide detailed information for local short term restrictions. The update rate is approximately every 20 minutes.

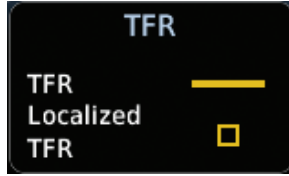

Figure 12-102 FIS-B TFR Legend



1. Touch a TFR symbol on the Weather page to view details.

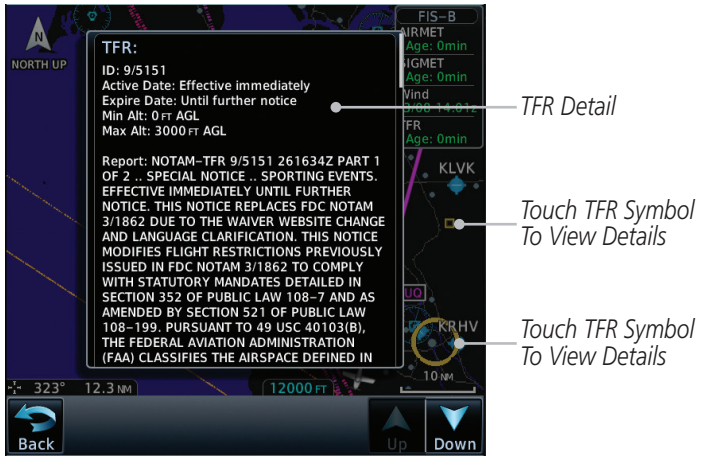

Figure 12-103 FIS-B TFR Detail



2. Touch the **Back** key to return to the Weather display.

12.6.4 Cloud Tops

Cloud tops indicate the altitude of the highest visible portions of a cloud at the time of measurement.

FIS-B cloud top data is generated by a computer model and has limited accuracy compared to actual conditions.

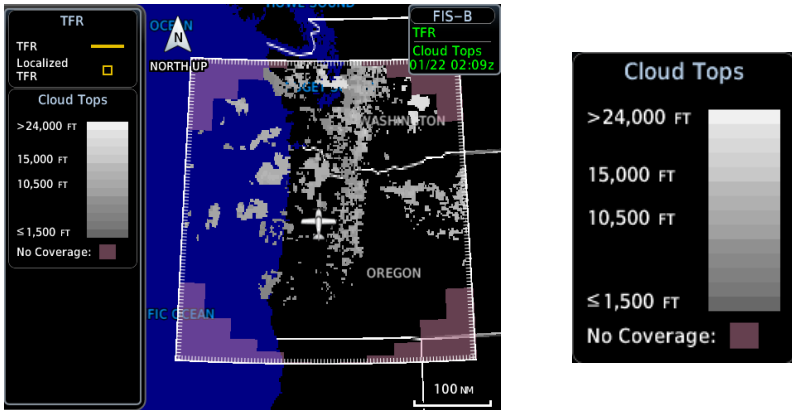

Figure 12-104 FIS-B Cloud Tops

Cloud Tops

1. While viewing the FIS-B Weather menu, touch the **Cloud Tops** key.

Foreword
Getting Started
Audio & Xpdr Ctrl
Com/Nav
FPL
Direct-To
Proc
Charts
Wpt Info
Map
Traffic
Terrain
Weather
Nearest
Services/Music
Utilities
System
Messages
Symbols
Appendix

12.6.5 Lightning

FIS-B lightning strikes display as a lightning bolt.

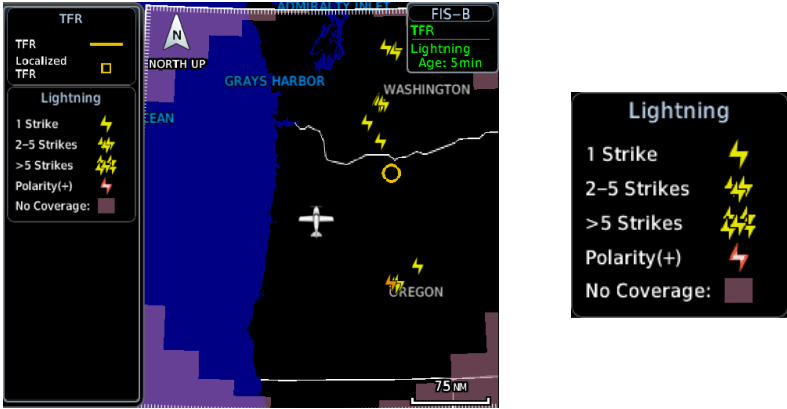

Figure 12-105 FIS-B Lightning



1. While viewing the FIS-B Weather menu, touch the **Lightning** key.

Foreword

Getting Started

Audio & Xpdr Ctrl

Com/Nav

FPL

Direct-To

Proc

Charts

Wpt Info

Map

Traffic

Terrain

Weather

Nearest

Services/ Music

Utilities

System

Messages

Symbols

Appendix

12.6.6 FIS-B METARs

When enabled, graphic METARs (METeoro logical Aviation Reports) are shown as colored flags at airports that provide METAR reports. Press the **METARs** key to enable or disable METARs. Refer to the Legend for a description of the color code. The update rate is every five minutes.





METAR Symbol	Description
	VFR (ceiling greater than 3000 ft. AGL and visibility greater than five miles)
	Marginal VFR (ceiling 1000–3000 ft. AGL and/or visibility three to five miles)
	IFR (ceiling 500 to below 1000 ft. AGL and/or visibility one mile to less than three miles)
	Low IFR (ceiling below 500 ft. AGL or visibility less than one mile)
	Unknown

Table 12-32 METAR Symbols

1. While viewing the FIS-B weather page, touch the **Menu** key to select the METAR choice. Touch an airport symbol for more METAR detail.

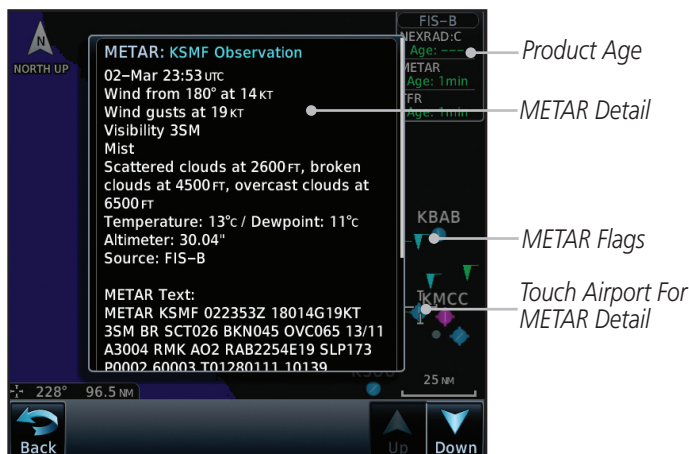
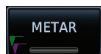

Figure 12-106 METARs

2. Touch the **METAR** key to toggle METARs on or off.
3. Touch the **Back** key to return to the FIS-B Weather page.



12.6.7 FIS-B SIGMETs and Textual AIRMETs

SIGMETs (SIGnificant METeological Information) and AIRMETs (AIRmen's METeological Information) are broadcast for potentially hazardous weather considered of importance to aircraft. The update rate is approximately every 20 minutes.



Figure 12-107 FIS-B SIGMET/AIRMET Legend



1. While viewing the FIS-B Weather menu, touch the **SIGMET/AIRMET** key.

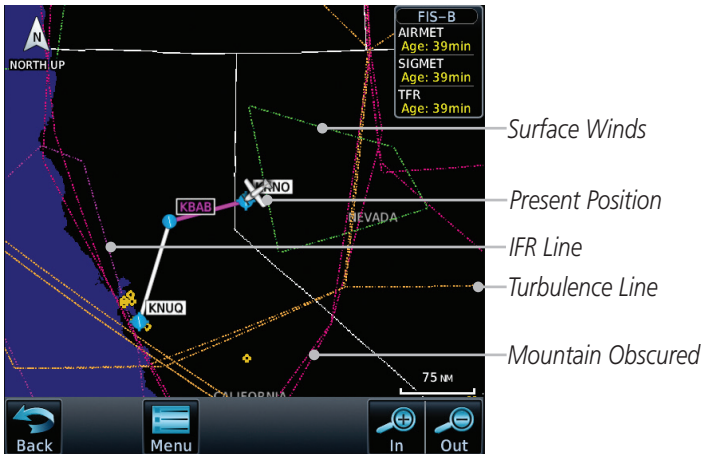

Figure 12-108 FIS-B SIGMETs and AIRMETS



2. Touch a SIGMET/AIRMET line to view details. Touch the **Back** key to return to the Weather display.



Figure 12-109 SIGMET and AIRMET Details



3. Touch the **SIGMET/AIRMET** key again to turn it off.

12.6.8 Graphical AIRMETS

Graphical AIRMETS (G-AIRMETS) display more weather phenomena than textual AIRMETS, while eliminating the need to interpret raw text. Updates occur four times daily. Filtering options allow you to mitigate page clutter.

Forecast Settings

Current (Auto): Displays active graphical records based on the current UTC. The function automatically switches from 0 hr to 3 hr forecasts.

All Forecasts: Displays the most recent, non-expired graphical records.

Off: Turns the G-AIRMETS product off.

Forecast Periods are 0 hr, 3 hr, and 6 hr.

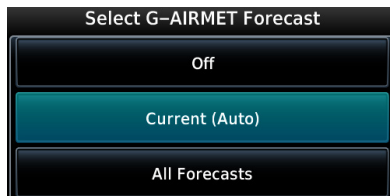

Figure 12-110 FIS-B G-AIRMET Forecast Settings

Foreword
Getting Started
Audio & Xpdr Ctrl
Com/Nav
FPL
Direct-To
Proc
Charts
Wpt Info
Map
Traffic
Terrain
Weather
Nearest
Services/Music
Utilities
System
Messages
Symbols
Appendix
Index

Filter Settings

Filters include: Freezing Level, Icing, IFR, Low-level Wind Shear, Mountain Obscuration, Surface Winds, and Turbulence.

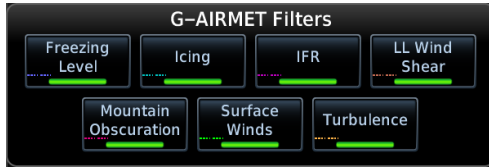

Figure 12-111 FIS-B G-AIRMET Filters

Viewing Graphical AIRMETS



1. While viewing the FIS-B Weather menu, touch the **G-AIRMET** key.

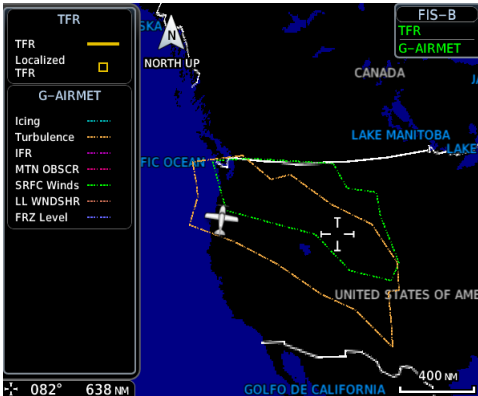
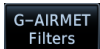

Figure 12-112 FIS-B G-AIRMETs

2. Select between Current (Auto), All Forecasts, or Off.
3. Select one or more filters.



4. Touch a G-AIRMET line to view details. Touch the **Back** key to return to the Weather display.

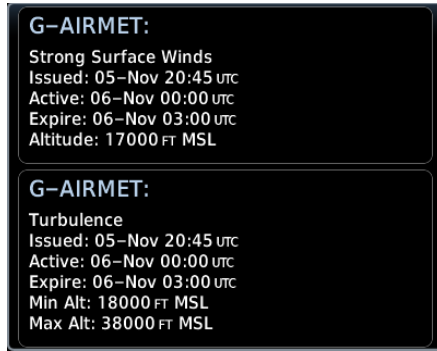

Figure 12-113 G-AIRMET Details

12.6.9 Center Weather Advisory

These advisories communicate en route and terminal weather conditions expected to occur within the next two hours.

Information is valid for up to 2 hours.

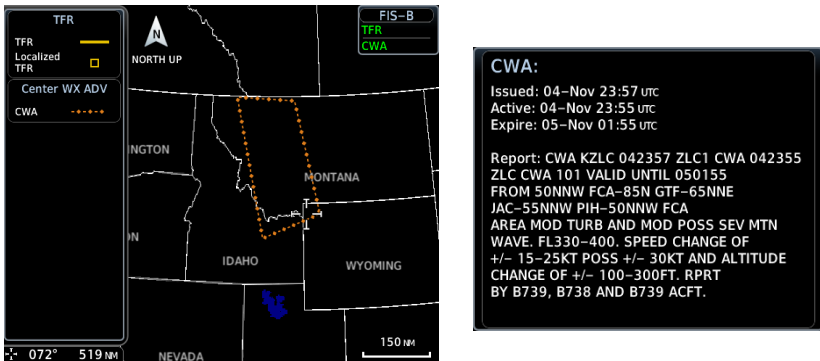

Figure 12-114 FIS-B Center Weather Advisory

1. While viewing the FIS-B Weather menu, touch the **Center WX Advisory** key.
4. Touch a CWA line to view details. Touch the **Back** key to return to the Weather display.



12.6.10 FIS-B Winds and Temperatures Aloft

Winds and Temperatures Aloft data shows the forecast wind speed, direction, and Temperature at selected altitudes. Altitudes can be selected in increments from 1,000 feet up to 53,000 feet. The update rate is every 12 hours.



1. While viewing the Data Link Weather menu, touch the **Wind/Temp Aloft** key.

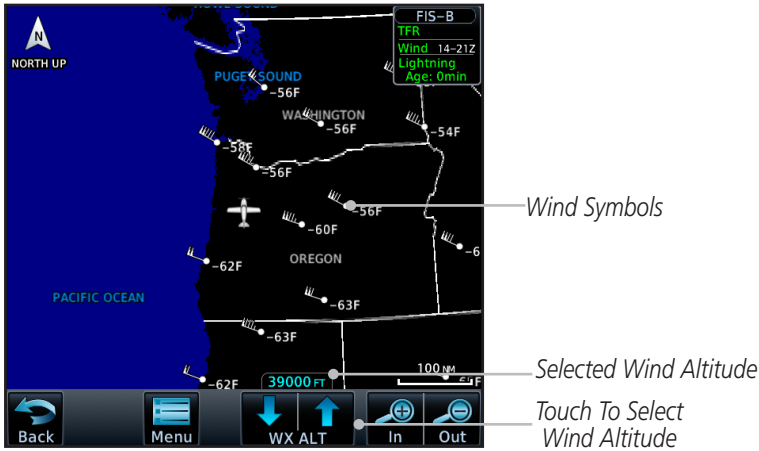

Figure 12-115 Winds Aloft



2. Touch the **WX Aloft ALT** **-** or **+** keys to increase or decrease the reporting altitude of the winds aloft in increments. The selected altitude is shown in a window above the altitude keys.



3. Touch the **Wind/Temp Aloft** key again to turn it off.

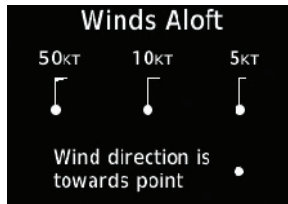

Figure 12-116 FIS-B Winds Aloft Legend

12.6.11 Icing



NOTE: Due to the incremental and overlapping nature of the FIS broadcast, timestamps, regional coverage, and map data availability may vary with altitude for computer generated icing forecasts.

Icing potential is not a forecast, but a presentation of icing potential at the time of analysis. For FIS-B, the icing timestamp shows the valid time in UTC.

Supercooled Large Droplet (SLD) icing conditions are characterized by the presence of relatively large, super cooled water droplets indicative of freezing drizzle and freezing rain aloft. SLD threat areas are depicted as black and pink blocks over the icing colors.

The icing potential shows a graphic view of the current icing conditions. Categories vary depending on the configured weather source. For FIS-B, they include: Trace, Light, Moderate, and Heavy.

Altitude Range: 2,000 to 24,000 ft.

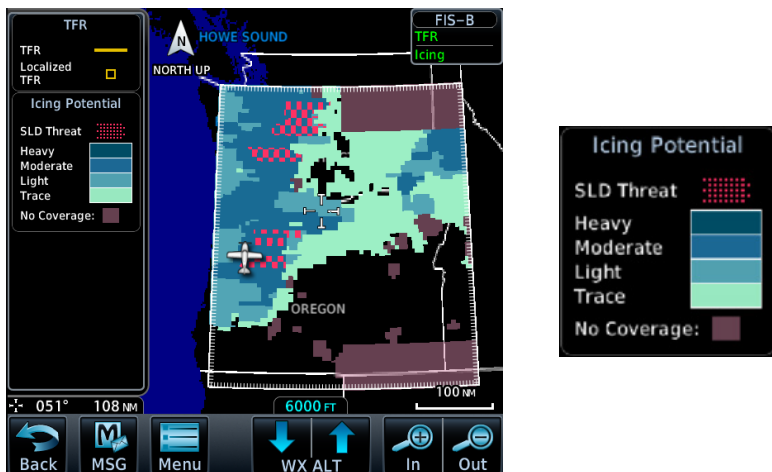
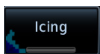

Figure 12-117 FIS-B Icing



1. While viewing the FIS-B Weather menu, touch the **Icing** key.

12.6.12 Turbulence



NOTE: Due to the incremental and overlapping nature of the FIS broadcast, timestamps, regional coverage, and map data availability may vary with altitude for FIS-B turbulence forecasts.

Turbulence is classified as light, moderate, severe, or extreme. Turbulence data is intended to supplement AIRMETs and SIGMETs.

For FIS-B, the turbulence timestamp shows the valid time in UTC.

Altitude Range: 2,000 to 24,000 ft (at 2,000 ft intervals).

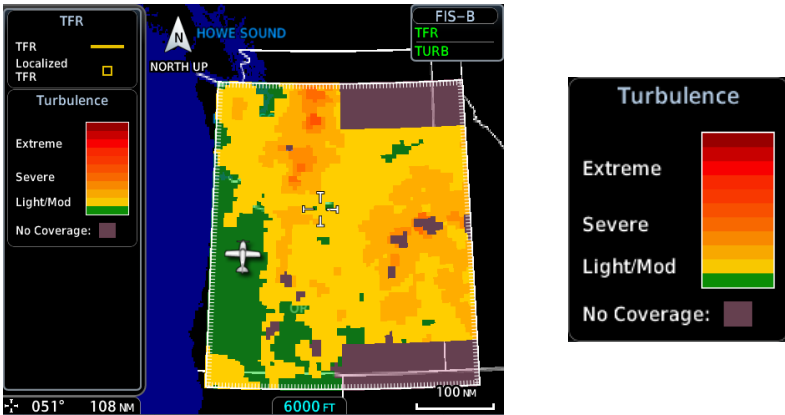

Figure 12-118 FIS-B Turbulence



1. While viewing the FIS-B Weather menu, touch the **Turbulence** key.

12.6.13 FIS-B PIREPs

Pilot Weather Reports (PIREPs) provide timely weather information. When significant weather conditions are reported or forecast, Air Traffic Control (ATC) facilities are required to solicit PIREPs. A PIREP may contain non-forecast adverse weather conditions, such as low in-flight visibility, icing conditions, wind shear, and turbulence. PIREPs are issued as either Routine (UA) or Urgent (UUA). The update rate is approximately every 20 minutes.

1. While viewing the FIS-B weather page, touch the **Menu** key to select the PIREP choice.
2. Touch the **PIREP** key to toggle PIREPs on or off.

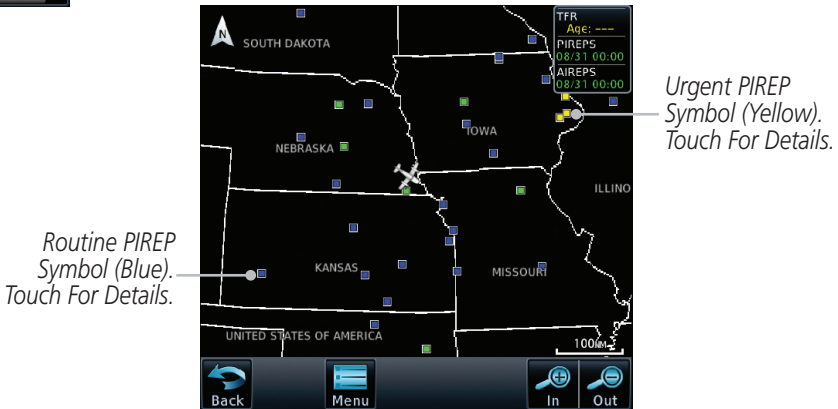

Figure 12-119 Weather Display With PIREP Information Active

3. Touch a weather information symbol to view details for that item.



Figure 12-120 PIREP Information Detail

4. Touch the **Back** key to remove the detailed information.
5. Touch the **PIREP** key again to turn it off.



Foreword

Getting
Started

Audio &
Xpdr Ctrl

Com/Nav

FPL

Direct-To

Proc

Charts

Wpt Info

Map

This page intentionally left blank

Traffic

Terrain

Weather

Nearest

Services/
Music

Utilities

System

Messages

Symbols

Appendix

13 NEAREST

The Nearest function provides detailed information for the 25 nearest airports, VORs, VRPs, NDBs, Intersections, and User waypoints within 200 NM of your current position. In addition, the Nearest pages include the five nearest Flight Service Station (FSS) and center (ARTCC/FIR) points of communication and alert you to any Special Use (SUA) or Controlled Airspace you may be in or near.

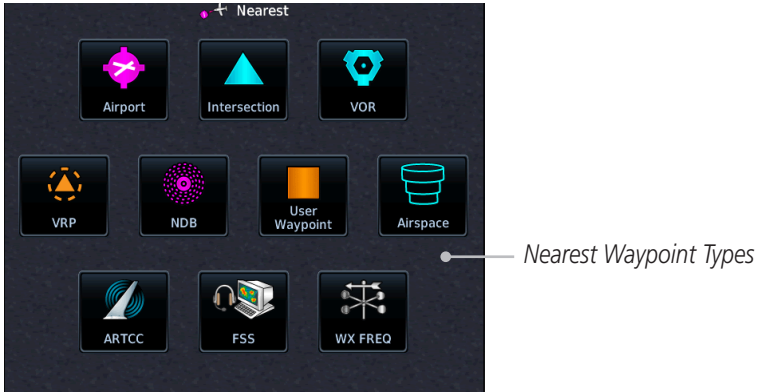

Figure 13-1 Nearest Page

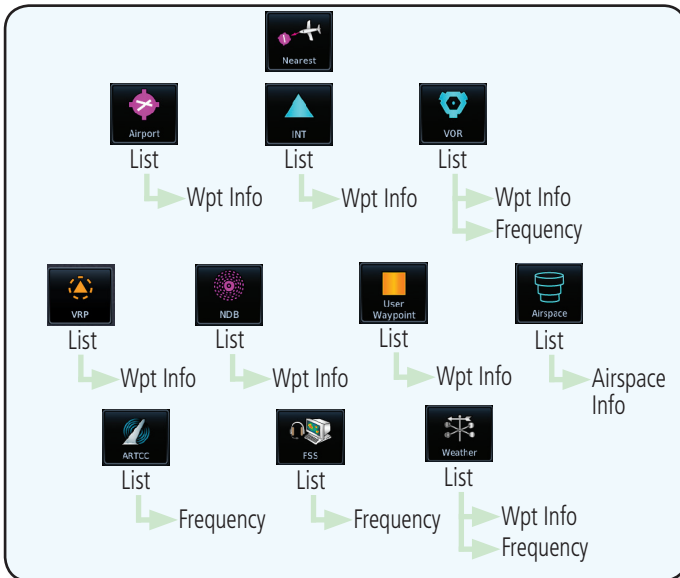

Figure 13-2 Nearest Page Functional Map

13.1 Select a Nearest Page

The available waypoint types are shown on the Nearest page. Touch the key to display the nearest 25 waypoint types (FSS and ARTCC will display up to five items). Not all 25 nearest waypoints can be displayed on the corresponding Nearest page at one time. The Nearest page displays detailed information for five nearest items.



1. On the Home page, touch the **Nearest** key.



2. Touch the desired waypoint type (Airport, VOR, etc.) and then touch the **Up** and **Down** keys on the lower right of the display to navigate through the list of available items. You can also touch an item on the list and drag your finger to scroll the list.

3. Touch the highlighted item to view more detailed information.



4. To navigate Direct-To the waypoint you're viewing, press the **Direct-To** key. The waypoint will be loaded into the Waypoint window of the Direct-To function.



5. Touch the **Activate** key to navigate directly to that waypoint.

13.2 Nearest Airport

The Nearest Airport Page displays the identifier, symbol, bearing and distance, and the length of the longest runway for the 25 nearest airports (within 200 NM of your present position).

The Nearest Airport Page can be configured to exclude shorter runways or undesirable runway surface types, so that the corresponding airports do not appear on the list. You may wish to use this feature to exclude seaplane bases, heliports, or runway lengths which would be difficult or impossible to land upon. See *System - Setup - Nearest Airport Criteria* for information about configuring the Nearest Airport display criteria.



1. While viewing the Nearest function, touch the **Airport** key. A list of the nearest 25 airports within 200 NM will be listed.

Airport Identifier



Scroll Bar Indicate More Items On The List

Airport Information

Figure 13-3 Nearest Airport



2. Touch the **Up** and **Down** keys to scroll through the list.



3. Touch the **Airport Identifier** key to show the Waypoint Info page for the selected airport.



Distance & Bearing Information Referenced To Current Position

Airport Information Page

Touch To View Charts When Available

Figure 13-4 Nearest Airport Waypoint Info

4. Touch one of the tabs (Map, Procedures, Runways, etc.) on the sides of the display for more information about the selected airport.

13.3 Nearest Intersection (INT)

The Nearest Intersection Page displays the identifier, symbol, bearing and distance to the 25 nearest intersections (within 200 NM of your present position).

1. While viewing the Nearest function, touch the **INT** key. A list of the nearest 25 Intersections within 200 NM will be listed.



Figure 13-5 Nearest Intersection List

2. Touch the **Up** and **Down** keys to scroll through the list.



Figure 13-6 Scrolling Down the Nearest Intersection List

JITSA
GR LKS USA

3. Touch the **Intersection Identifier** key to show the Waypoint Info page for the selected Intersection.



Distance & Bearing Information Referenced To Current Position

Intersection Map Detail

Map Range Keys

Figure 13-7 Nearest Intersection Waypoint Detail

Foreword

Getting Started

Audio & Xpdr Ctrl

Com/Nav

FPL

Direct-To

Proc

Charts

Wpt Info

Map

Traffic

Terrain

Weather

Nearest

Services/ Music

Utilities

System

Messages

Symbols

Appendix

13.4 Nearest VOR

The Nearest VOR Page displays the identifier, symbol, bearing and distance to the 25 nearest VORs (within 200 NM of your present position). For each VOR listed, the Nearest VOR Page also indicates the frequency and may be used to quickly tune the Nav radio to the nearby VOR (GTN 750 only).

Touch the VOR Frequency key to place the frequency in the standby field of the Nav window. Touch the **Nav** Active window to flip/flop the Nav frequencies.

1. While viewing the Nearest function, touch the **VOR** key. A list of the nearest 25 VORs within 200 NM will be listed.

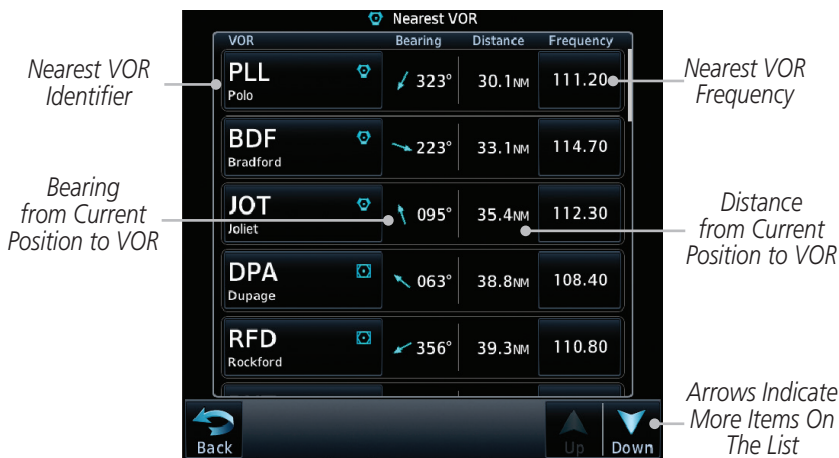

Figure 13-8 Nearest VOR List and Information

2. Touch the **Up** and **Down** keys to scroll through the list.



MCI
Kansas City

3. Touch the **VOR Identifier** key to show the Waypoint Info page for the selected VOR.



VOR Information
Referenced To Current
Position

Additional VOR Information

VOR Map Detail

VOR Location

Figure 13-9 Nearest VOR Waypoint Information

Frequency
113.25

4. Touch the **Frequency** key on this page or from the Nearest VOR List page to place the selected frequency into the Nav Standby window.

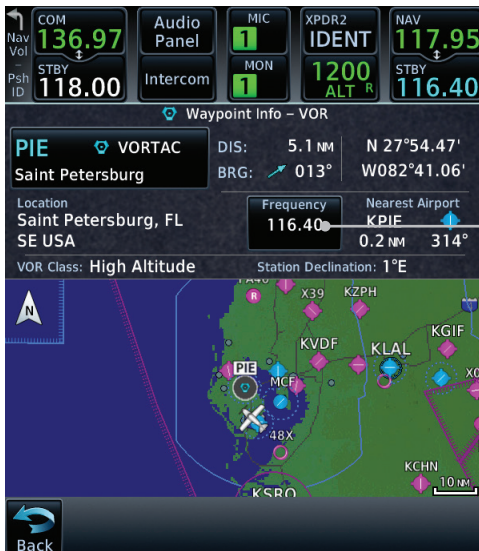

Touch to Flip/Flop

VOR Frequency Inserted
Into Standby Window.

VOR Frequency

Figure 13-10 Nearest VOR Frequency Entry

13.5 Nearest VRP



NOTE: This feature is available in software v6.20 or later.

The Nearest VRP Page displays the identifier, symbol, bearing, and distance to the 25 nearest VRPs (within 200 NM of your present position).



1. While viewing the Nearest function, touch the **VRP** key.

Bearing from Current Position to VRP



Figure 13-11 Nearest VRPs



2. Touch the **Up** and **Down** keys to scroll through the list.

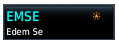

3. Touch the **VRP Identifier** key to show the Waypoint Info page for the selected VRP.

Foreword
Getting Started
Audio & Xpdr Ctrl
Com/Nav
FPL
Direct-To
Proc
Charts
Wpt Info
Map
Traffic
Terrain
Weather
Nearest
Services/Music
Utilities
System
Messages
Symbols
Appendix

VRP Information
Referred to
Current Position



Figure 13-12 Waypoint Info - Visual Reporting Point

Foreword

Getting Started

Audio & Xpdr Ctrl

Com/Nav

FPL

Direct-To

Proc

Charts

Wpt Info

Map

Traffic

Terrain

Weather

Nearest

Services/
Music

Utilities

System

Messages

Symbols

Appendix

13.6 Nearest NDB

The Nearest NDB Page displays the identifier, symbol, bearing, distance and frequency to the 25 nearest NDBs (within 200 NM of your present position).

1. While viewing the Nearest function, touch the **NDB** key. A list of the nearest 25 NDBs within 200 NM will be listed.



NDB	Bearing	Distance	Frequency
DKB Dekalb	191°	0.5 NM	209.0
RF Gilmy	303°	20.4 NM	275.0
ME Deana	090°	30.4 NM	350.0 WX
OIX Ottawa	194°	35.4 NM	266.0
HK Ermin	111°	41.2 NM	332.0

Scroll Bar Indicates More Items On The List. Touch And Drag Finger To Scroll.

NDB Identifier

NDB Information

Arrows Indicate More Items On The List

Figure 13-13 Nearest NDB

2. Touch the **Up** and **Down** keys to scroll through the list.
3. Touch the **NDB Identifier** key to show the Waypoint Info page for the selected NDB.



Waypoint Info - NDB

RF
Gilmy

DIS: 19.4 NM N 42°06.86'
BRG: 298° W089°05.92'

Location: Rockford, IL
GR LKS USA

Frequency: 275.0 Nearest Airport: KRFD
4.9 NM 003°

Marker Description: Compass Locator

Map Range Keys: In, Out

Distance and Bearing Referenced To Current Position

NDB Map Detail

Map Range Keys

Figure 13-14 Nearest NDB Waypoint Information

13.7 Nearest User Waypoint

The Nearest User Waypoint Page displays the name, bearing and distance to the 25 nearest user waypoints (within 200 NM of your present position).



1. While viewing the Nearest function, touch the **User Waypoint** key. A list of the nearest 25 User waypoints within 200 NM will be listed.



Figure 13-15 Nearest User Waypoint



2. Touch the **Up** and **Down** keys to scroll through the list.

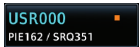

3. Touch the **User Identifier** key to show the Waypoint Info page for the selected User waypoint.

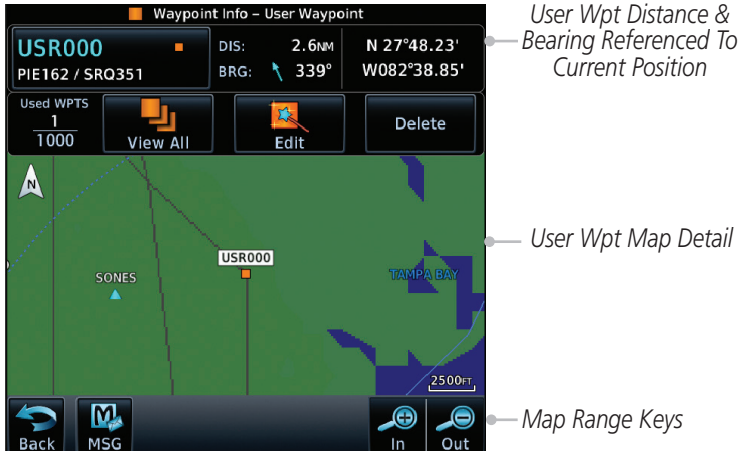

Figure 13-16 Nearest User Waypoint Information

13.8 Nearest Airspace

The Nearest Airspace Page, alerts you to as many as 25 controlled or special use airspaces near or in your flight path. Alerts are provided according to the following conditions:

- If your projected course will take you inside an airspace within the next ten minutes, the alert message “*AIRSPACE ALERT - Airspace entry in less than 10 minutes*” appears. The Nearest Airspace Page shows the airspace as “Airspace Ahead.”
- If you are within two nautical miles of an airspace and your current course will take you inside, the message “*AIRSPACE ALERT - Within 2nm of airspace*” appears. The Nearest Airspace Page shows the airspace as “Airspace Within 2 NM.”
- If you are within two nautical miles of an airspace and your current course will take you inside in less than 10 minutes, the message “*AIRSPACE ALERT - Airspace within 2nm and entry in less than 10 minutes*” appears. The Nearest Airspace Page shows the airspace as “Ahead < 2 NM.”
- If you have entered an airspace, the message “*AIRSPACE ALERT - Inside Airspace*” appears. The Nearest Airspace Page shows “Inside of airspace.”

Note that the airspace alerts are based on three-dimensional data (latitude, longitude and altitude) to avoid nuisance alerts. The alert boundaries for controlled airspace are also sectorized to provide complete information on any nearby airspace. Once one of the described conditions exists, the message annunciator flashes, alerting you of an airspace message (if airspace alert messages are enabled). See *System-Alerts* to set the Arrival Alert Proximity, Airspace Type, and Altitude Buffer values.



NOTE: *The Airspace Alert setting does not alter the depiction of airspace, or change the Smart Airspace setting for the main map page.*

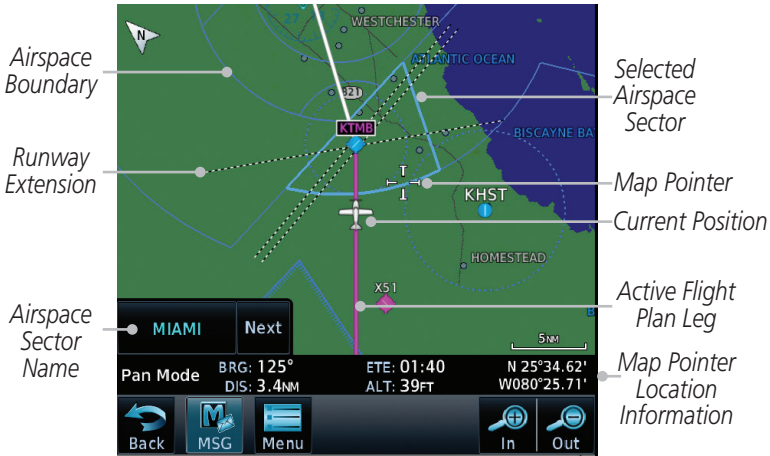

Figure 13-17 Airspace Sectors

1. While viewing the Nearest function, touch the **Airspace** key. A list of the nearest 25 Airspaces within 200 NM along the aircraft flight path will be listed, depending on the airspace types and values set by the user.



Figure 13-18 Nearest Airspace List



2. Touch the **Up** and **Down** keys to scroll through the list.



3. Touch the **Airspace Identifier** key to show the Waypoint Info page for the selected Airspace.

- Foreword
- Getting Started
- Audio & Xpdr Ctrl
- Com/Nav
- FPL
- Direct-To
- Proc
- Charts
- Wpt Info
- Map
- Traffic
- Terrain
- Weather
- Nearest**
- Services/ Music
- Utilities
- System
- Messages
- Symbols
- Appendix



Figure 13-19 Nearest Airspace Waypoint Information

Once you have been provided an airspace alert message, detailed information concerning the specific airspace is provided on the Nearest Airspace Page. The Nearest Airspace Page displays the airspace name, status (“AIRSPACE ALERT - inside Airspace,” “AIRSPACE ALERT - Airspace entry in less than 10 minutes,” etc.), and a time to entry (if applicable). By selecting any airspace name listed on the Nearest Airspace Page, additional details are provided — including controlling agency, communication frequencies and floor/ceiling limits.

13.9 Nearest ARTCC

The Nearest ARTCC page displays the facility name, bearing to, distance, and frequency to the five nearest Air Route Traffic Control Center (ARTCC) points of communication (within 200 NM of your present position). For each ARTCC listed, the Nearest ARTCC page also indicates the frequency(s) and may be used to quickly tune the COM transceiver to the center's frequency.

Touch the ARTCC Frequency key to place the frequency in the standby field of the COM window. Touch the **COM** Active window to flip/flop the Com frequencies (GTN 750 only).



1. While viewing the Nearest function, touch the **ARTCC** key. A list of the nearest five ARTCCs within 200 NM will be listed.



Figure 13-20 Nearest ARTCC



2. Touch the **Up** and **Down** keys to scroll through the list as needed.

Foreword
Getting Started
Audio & Xpdr Ctrl
Com/Nav
FPL
Direct-To
Proc
Charts
Wpt Info
Map
Traffic
Terrain
Weather
Nearest
Services/Music
Utilities
System
Messages
Symbols
Appendix

**Multiple
FREQ**

- The Frequency category will show "Multiple" keys if multiple frequencies are available. Touch the **Multiple FREQ** key to display the frequencies.



Figure 13-21 Nearest ARTCC Multiple Frequency List

135.17

- Touch the key for the desired frequency to place the selected frequency into the Com Standby window.

Touch To Flip/Flop Active And Standby Frequencies
Selected ARTCC Frequency Inserted Into Standby Window



Figure 13-22 Selected ARTCC Frequency From List

13.10 Nearest Flight Service Station (FSS)

The Nearest Flight Service Station (FSS) Page displays the facility name, bearing to, distance, and frequency to the five nearest FSS points of communication (within 200 NM of your present position). For each FSS listed, the Nearest FSS Page also indicates the frequency(s) and may be used to quickly tune the COM transceiver to the FSS's frequency.

Touch the FSS Frequency key to place the frequency in the standby field of the COM window. Touch the **COM** Active window to flip/flop the Com frequencies (GTN 750 only). Receive-only frequencies are noted with a white "RX."



1. While viewing the Nearest function, touch the **FSS** key. A list of the nearest five FSSs within 200 NM will be listed.



Figure 13-23 Nearest FSS



2. Touch the **Up** and **Down** keys to scroll through the list, if necessary.

Foreword
Getting Started
Audio & Xpdr Ctrl
Com/Nav
FPL
Direct-To
Proc
Charts
Wpt Info
Map
Traffic
Terrain
Weather
Nearest
Services/Music
Utilities
System
Messages
Symbols
Appendix

Multiple
FREQ

- The **Frequency** key will show "Multiple FREQ" if multiple frequencies are available. Touch the **Multiple FREQ** key to display the frequencies.

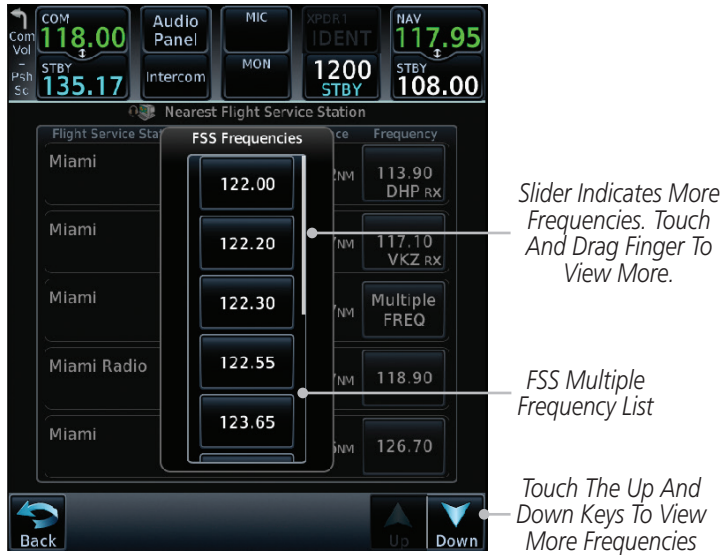

Figure 13-24 Nearest FSS Multiple Frequency List

122.20

- Touch the key for the desired frequency to place the selected frequency into the Com Standby window.

Selected FSS
Frequency Inserted
Into Standby Window



Figure 13-25 Selected FSS Frequency From List

13.11 Nearest Weather Frequency (WX Freq)

The Nearest WX FREQ function displays facility name, bearing to, distance, and frequency for the nearest 25 Automatic Terminal Information Service (ATIS), Automated Service Observing System (ASOS), and Automated Weather Observing Station (AWOS) weather reporting stations within 200 NM.



1. While viewing the Nearest function, touch the **WX FREQ** key. A list of the nearest 25 Weather stations within 200 NM will be listed.

Reporting Weather Waypoint Information

Waypoint	Bearing	Distance	Frequency
KMKY Marco I	← 300°	66.7 NM	120.07 AWOS
KLNA Palm Beach Co Park	↑ 027°	68.1 NM	119.92 AWOS
KIMM Immokalee Regl	↘ 325°	70.7 NM	118.52 AWOS
KPBI Palm Beach Intl	↑ 025°	72.9 NM	123.75 ATIS
KPBI Palm Beach Intl	↑ 025°	72.9 NM	123.75 ASOS

Reporting Weather Waypoint Identifier

AWOS Frequency

ATIS Frequency

ASOS Frequency

Arrows Indicate More Items On The List

Back Up Down

Figure 13-26 Nearest Weather Station



2. Touch the **Up** and **Down** keys to scroll through the list, as needed.

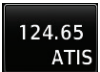

3. Touch the key for the desired frequency to place the selected frequency into the Com Standby window.

Foreword
Getting Started
Audio & Xpdr Ctrl
Com/Nav
FPL
Direct-To
Proc
Charts
Wpt Info
Map
Traffic
Terrain
Weather
Nearest
Services/Music
Utilities
System
Messages
Symbols
Appendix

Foreword
Getting Started
Audio & Xpdr Ctrl
Com/Nav
FPL
Direct-To
Proc
Charts
Wpt Info
Map
Traffic
Terrain
Weather
Nearest
Services/Music
Utilities
System
Messages
Symbols
Appendix

Selected Weather Frequency Inserted Into Standby Window



Selected Weather Frequency Key

Figure 13-27 Nearest Weather Station Selected Frequency

4. Touch the **Weather Station Identifier** key to show the Waypoint Info page for the selected Weather station.

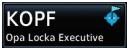

Wpt Identifier, Type, and Name



Dis and Brg Information Referenced To Current Position

Weather Tab Selected

Wpt Information Detail

Figure 13-28 Nearest Weather Station Waypoint Information

14 SERVICES/MUSIC

The Services function is available when certain optional features are installed and enabled. The key will be labeled as Music when only the Music feature is enabled. Music is provided through SiriusXM Satellite Radio. The GSR 56 is an Iridium® satellite transceiver that supports voice telephone calls, aircraft position reporting, and world wide weather products.



While viewing the Home page, touch the **Services** key to view the Services page.

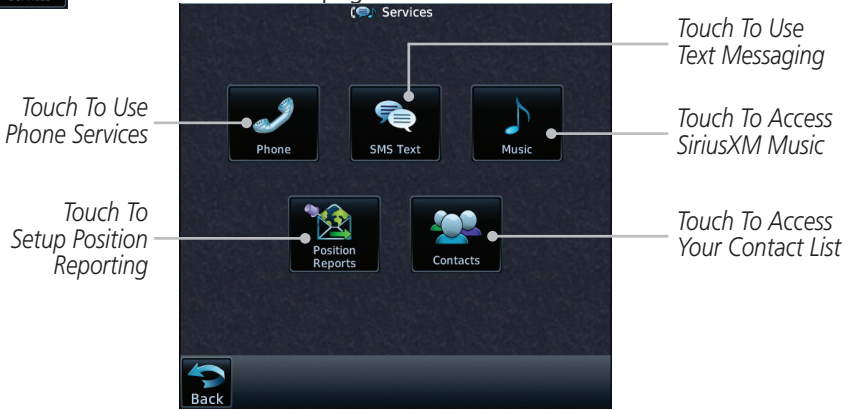

Figure 14-1 Services Page

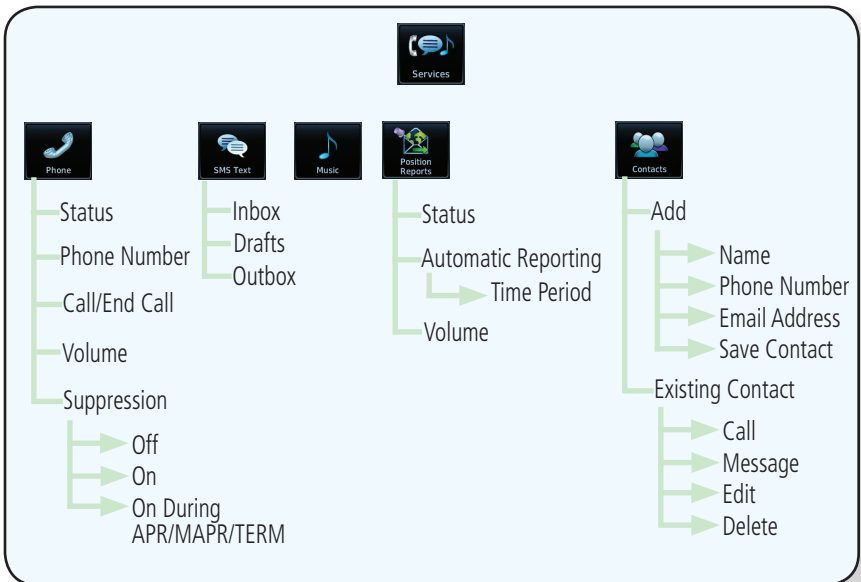

Figure 14-2 Services Functional Diagram

14.1 Music



NOTE: Refer to the *Weather* section for information about *SiriusXM Weather* products.

The optional SiriusXM Satellite Radio entertainment feature of the GDL 69A Data Link Receiver is available for the pilot's and passengers' enjoyment. The GDL 69A can receive SiriusXM Satellite Radio entertainment services at any altitude throughout the Continental U.S. Entertainment audio is not available on the GDL 69 Data Link Receiver.

SiriusXM Satellite Radio offers a variety of radio programming over long distances without having to constantly search for new stations. Based on signals from satellites, coverage far exceeds land-based transmissions. SiriusXM Satellite Radio services are subscription-based. For more information on XM service packages, visit flyGarmin.com.

Audio entertainment is available through the SiriusXM Satellite Radio Service when activated in the optional installation of the GDL 69A. The GTN unit serves as the display and control head for your remotely mounted GDL 69A. When enabled, the SiriusXM Satellite Radio audio entertainment is accessible in the Music function.

The information on the SiriusXM Satellite Radio display is composed of four areas: the Active Channel, Available Channels, Category of the highlighted channel, and the Volume setting. The Active Channel window shows the Channel Name and Number, Artist, Song Title, and Category.

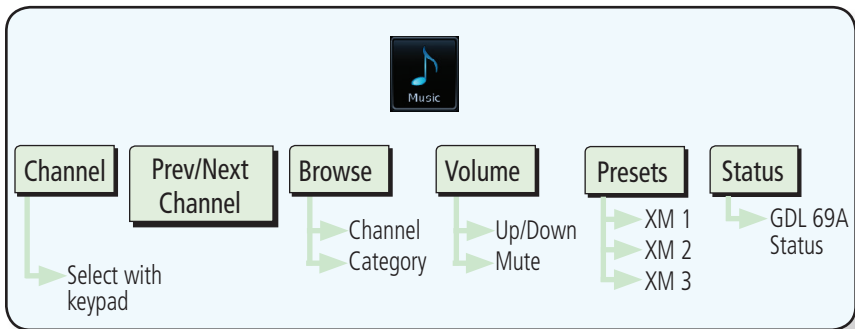

Figure 14-3 Music Functional Diagram

14.2 Activating SiriusXM Satellite Radio Services

The service is activated by providing SiriusXM Satellite Radio with either one or two coded IDs, depending on the equipment. Either the Audio Radio ID or the Data Radio ID, or both, must be provided to SiriusXM Satellite Radio to activate the entertainment subscription. Activation instructions are included with the GDL 69A, P/N 190-00355-04. They are also available at flyGarmin.com.

It is not required to activate both the entertainment and weather service subscriptions with the GDL 69A. Either or both services can be activated. SiriusXM Satellite Radio uses one or both of the coded IDs to send an activation signal that, when received by the GDL 69A, allows it to play entertainment programming.

These IDs are located:

- On the label on the back of the Data Link Receiver
- On the Music Menu

Contact the installer if the Data Radio ID and the Audio Radio ID cannot be located.



NOTE: Refer to the *GDL 69/69A SiriusXM Satellite Radio Activation Instructions (P/N 190-00355-04)* for further information.

1. Contact SiriusXM Satellite Radio through the e-mail address listed on their website (www.siriusxm.com) or by the customer service phone number listed on the website (1-800-985-9200).
2. Follow the instructions provided.

If SiriusXM weather services have not been activated, all the weather product boxes are cleared on the XM Information Page and a yellow Activation Required message is displayed in the center of the Weather Data Link Page (Map Page Group). The Service Class refers to the groupings of weather products available for subscription.

14.3 Music Operation

The GTN 7XX provides control for enjoying SiriusXM Satellite Radio audio entertainment in the aircraft. The Music function allows selecting music categories and specific channels, as well as saving category and channel selections as presets for quick recall. The music volume level may also be managed.

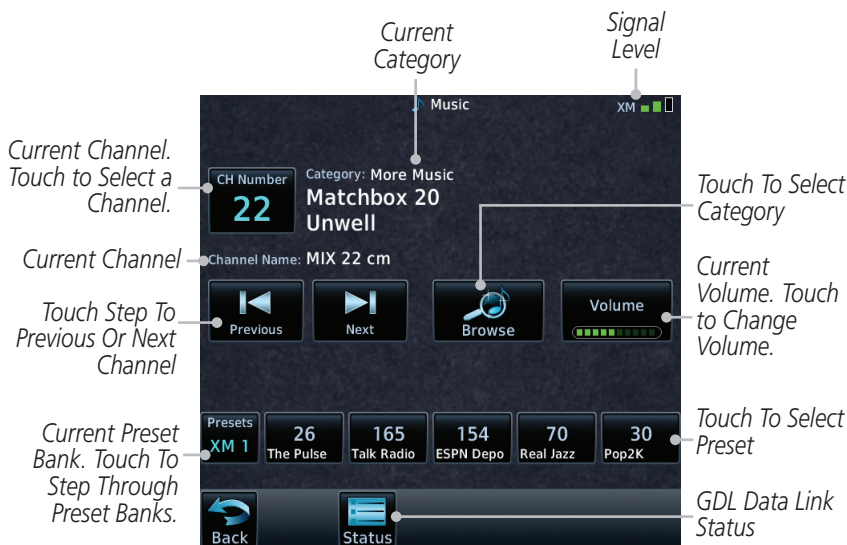

Figure 14-4 Main Music Display

14.3.1 Browsing Channels and Categories

The Category window displays the currently selected category of audio. Categories of channels, such as Jazz, Rock, or News, can be selected to list the available channels for a type of music or other contents.



1. While viewing the Music page, touch the **Browse** key and then touch the desired channel to select it.



Figure 14-5 Music Channels



2. Touch the **Category** key to activate Category selection and then touch the desired **Category** to select it.



Figure 14-6 Music Categories

3. The current category will be shown at the top of the display.

14.3.2 Selecting an SiriusXM Satellite Radio Channel by Number

Channels may be selected directly in the selected category using the numeric keypad.

1. While viewing the main Music page, touch the **Channel** key. The Channel Number selection page will appear.



Touch Channel Key

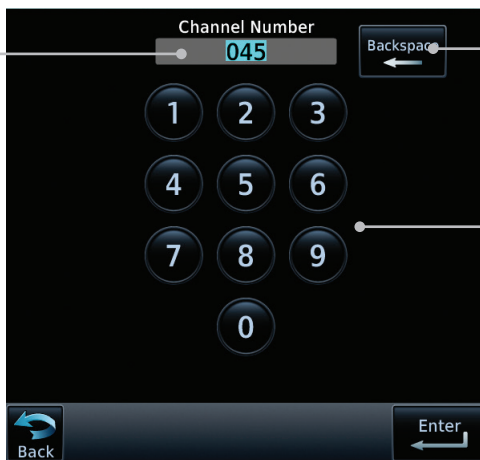

Figure 14-7 Selecting Music Channels

2. Use the numeric keys to enter the number for the desired channel and then touch the **Enter** key.



Channel Number Window



Touch to Clear Channel Number Window

Numeric Keypad for in Channel Number Selection

Touch to Select Channel Shown in Channel Number Window

Figure 14-8 Selecting Music Channels with the Numeric Keypad

14.3.3 SiriusXM Satellite Radio Volume

The Volume control allows you to set the audio volume level, as well as mute the audio.



1. While viewing the Music page, touch the **Volume** key.

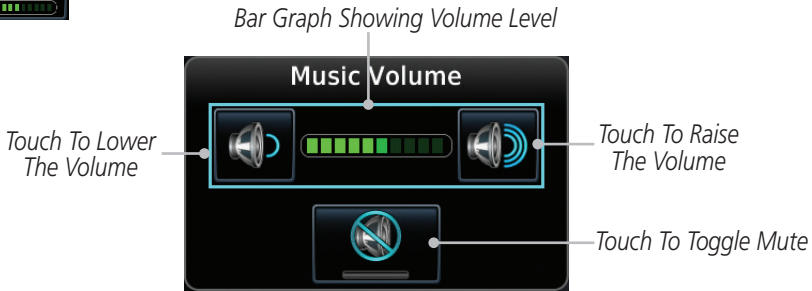

Figure 14-9 Music Volume Control



2. Touch the **Up** or **Down** Volume keys to adjust the radio volume.



3. Touch **MUTE** to toggle muting of the radio volume.



4. Touch **MUTE** again or the **Volume** key to unmute the radio volume.

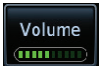

14.3.4 SiriusXM Satellite Radio Channel Presets

The Music Menu allows you to store the Active Channel into a selected preset position for easy later recall. A delay of several seconds can occur when setting or recalling a preset.



Figure 14-10 Music Presets

14.3.4.1 Saving a Preset

1. While viewing the desired channel, select the preset bank for saving the preset (XM 1, XM 2, or XM 3) by touching the **Presets** key until the desired bank is shown.
2. Touch the desired Preset key and hold it for three seconds.

14.3.4.2 Recalling a Preset

1. Touch the **Presets** key to select the preset bank (XM 1, XM 2, or XM 3).
2. Touch the desired Preset key.

14.3.5 GDL 69/69A Data Link Receiver Troubleshooting

Some quick troubleshooting steps listed below can be performed to find the possible cause of a failure.

- Ensure the owner/operator of the aircraft in which the Data Link Receiver is installed has subscribed to SiriusXM Satellite Radio
- Ensure the SiriusXM Satellite Radio subscription has been activated
- Perform a quick check of the circuit breakers to ensure that power is applied to the Data Link Receiver

For troubleshooting purposes, check the Menu on the Music Page or the GDL 69 Box on the System - External LRUs Page for Data Link Receiver (GDL 69/69A) status, serial number, and software version number.

It may take several minutes for all subscribed data to become available after power-up.

1. Touch the **Status** key on the Music page to display the GDL 69/69A Status.

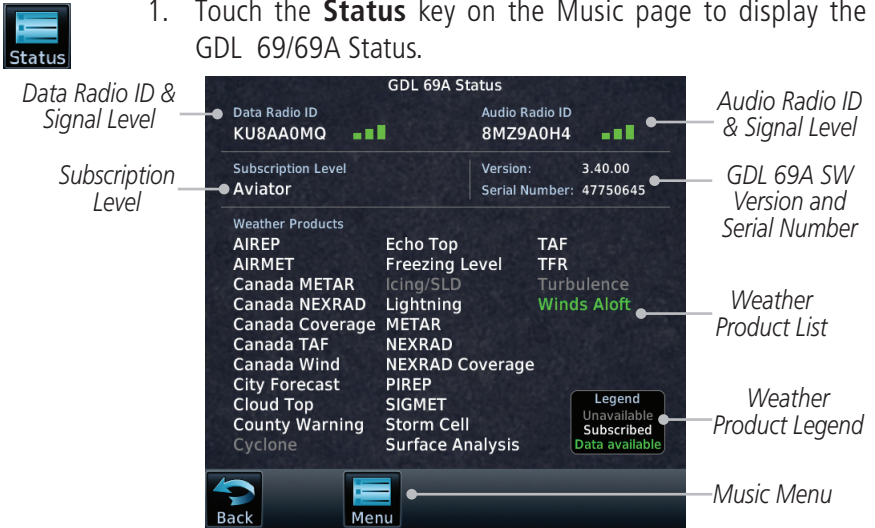

Figure 14-11 GDL 69 Status Page

- Foreword
- Getting Started
- Audio & Xpdr Ctrl
- Com/Nav
- FPL
- Direct-To
- Proc
- Charts
- Wpt Info
- Map
- Traffic
- Terrain
- Weather
- Nearest
- Services/ Music
- Utilities
- System
- Messages
- Symbols
- Appendix
- Index

2. The GDL status information is provided on this page.
3. Touch the **Menu** key to display the GDL Status Menu.

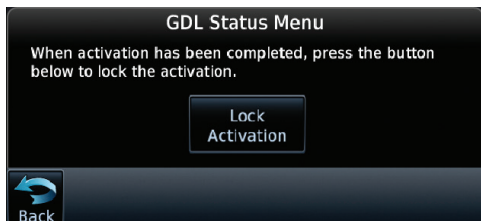

Figure 14-12 GDL Status Menu

4. Touch the **Lock Activation** key if this is for the initial subscription or a change in the subscription. Touch the **OK** key to continue the operation.

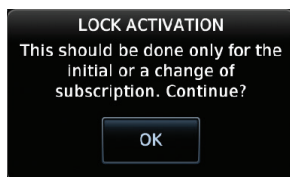
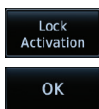

Figure 14-13 Lock Activation

14.4 Iridium Phone Operation (Optional)

Optional satellite telephone operation is available through the Iridium® satellite system that is interfaced through the Garmin GSR 56.



Figure 14-14 Services Phone Page

14.4.1 Status

The Status section shows the Call Time, Phone Status, and Call Suppression selected. The Call Time value shows the length of the call time for the current call using the Iridium phone. Phone Status shows the current operating status of the Iridium phone.

Status	Description
Idle	The Iridium phone is not using the GSR 56 for communicating at this time.
Initializing	The GSR 56 and its driver are currently initializing.
Connected	The GSR 56 is connected to the called number.
Connecting Call	The GSR 56 is in the process of connecting to the called number.
Changing Volume	The volume level on the GSR 56 is changing.
Busy	The phone is in use by another service and the call may not be made.
Dialing	The GSR 56 is dialing the called number.
Incoming Call	A call is being made to the GSR 56.
Hanging Up	The GSR 56 is disconnecting from the current call.
Unavailable	The GSR 56 is currently not usable by the Iridium phone system.

Table 14-1 Iridium Phone Status

14.4.2 Making a Phone Call



1. While viewing the Iridium Phone page, touch **Phone**, select a phone number, or select one from Contacts.



Figure 14-15 Making a Phone Call

2. Touch **Enter** to accept the selected number.
3. Touch the **Call** key.

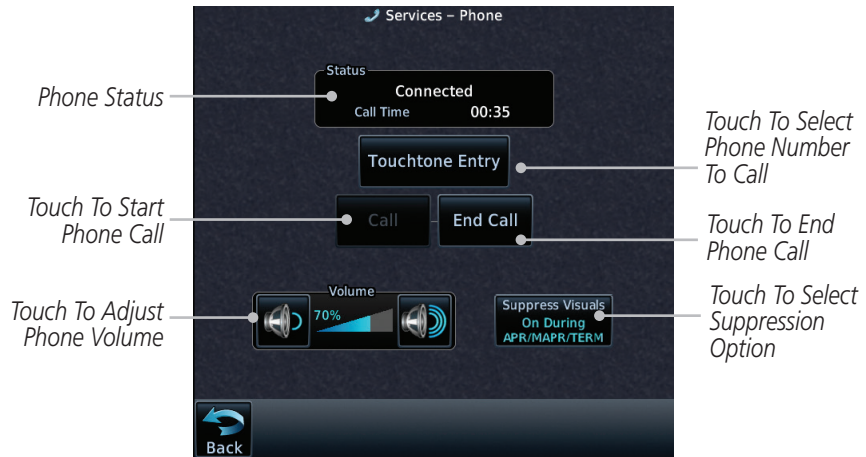

Figure 14-16 Phone Call In Progress

4. To make a direct call with a keypad, touch the **Touchtone Entry** key.

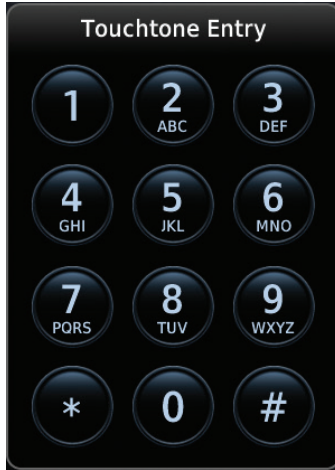

Figure 14-17 Touchtone Entry Pad

5. After completing the call, touch the **End Call** key.

14.4.3 Answering a Phone Call

An incoming phone call will generate a pop-up announcing the call. When a call is accepted, the pop-up will show that the call is connected and the cumulative call time will be shown.

1. When an incoming call is available, touch the **Enter** key or the **ANSWER** key to answer the call. Or, press the **Ignore** key to not answer the call and hang up.



Figure 14-18 Incoming Call Pop-Up

2. After a called is accepted and connected, the connection time will be shown on the pop-up. Touch the **ATT** soft key to attenuate the call volume; touching it again will return to normal volume. Touch the **HANG UP** soft key to end the call.

14.4.4 Suppress Visuals

Call Suppression controls calling when use of the Iridium phone system is allowed.



NOTE: The “Suppress Visuals” setting only affects the visual indication of an incoming call/text. It does not inhibit the phone ringer or incoming SMS chime. Garmin recommends that you inhibit the audio from the GSR 56 unless a phone call is active.

Status	Description
Off	Call Suppression is turned off. Calls may be transmitted and received through the Iridium phone.
On	Call Suppression is turned on. The incoming call pop-up will not be shown. The call may still be answered on the phone page. Outgoing calls are not affected.
On During APR/MAPR/TERM	Call Suppression is turned on during Approach, Missed Approach, and Terminal operations. The incoming call pop-up will not be shown. The call may still be answered on the phone page. Outgoing calls are not affected.

Table 14-2 Call Suppression



1. While viewing the Iridium Phone page, touch the **Suppression** key.
2. Touch the desired Call Suppression type.

Touch To Select The Desired Suppression



Figure 14-19 Select Call/SMS Suppression

3. Or, press **Back** to return to the Phone page without making a selection.

14.4.5 Phone Volume

Use the Phone Volume controls to adjust the loudness of the phone calls you hear. Volume controls will only be available when the Idle, Connected, or Changing Volume states are displayed.

Adjusting the Phone Volume with the Soft Keys



1. While viewing the Iridium Phone page, touch the **VOL** keys to adjust the phone volume.

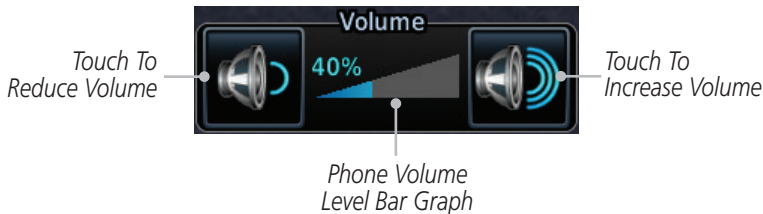

Figure 14-20 Select Soft Keys for Phone Volume Adjustment

2. The phone volume level is shown as a bar graph.

14.4.6 SMS Text Operation

Send and receive text messages through the GSR 56 phone connection.



1. While viewing the Services page, touch the **SMS Text** key.

Touch To Compose
New Message

Touch To Received
Messages

Touch To View
Draft Messages

Touch To View
Sent Messages

Touch To Return
To Previous Page

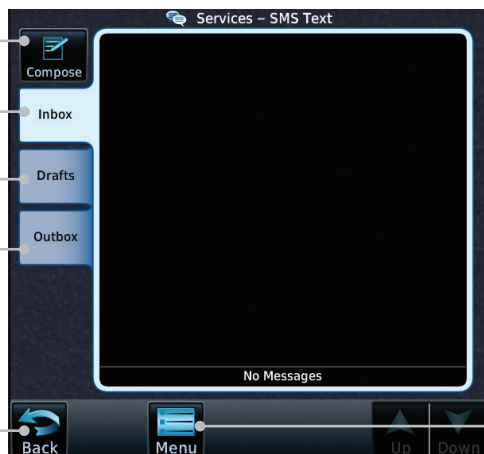

Touch To View
SMS Text Menu

Figure 14-21 SMS Text Page

2. Select Compose, Inbox, Drafts, or Outbox.

14.4.6.1 SMS Text Messaging Menu

The SMS Text Messaging Menu allows you to sort, mark, or delete messages and select call suppression.



Figure 14-22 SMS Text Messaging Menu



1. Touch the **Time** key to sort messages by Time or the **Address** key to sort by Address.
2. Touch the **Suppression** key and then touch the call suppression choice. The current choice will be shown on the **Suppression** key.
3. While viewing the Inbox, Drafts, or Outbox, touch the **Mark All As Read** to tag the messages as having been read.
4. Touch the **Delete All Messages** to delete the messages in the viewed category.

14.4.6.2 Composing a SMS Text Message



1. While viewing the SMS Text page, touch the **Compose** key.

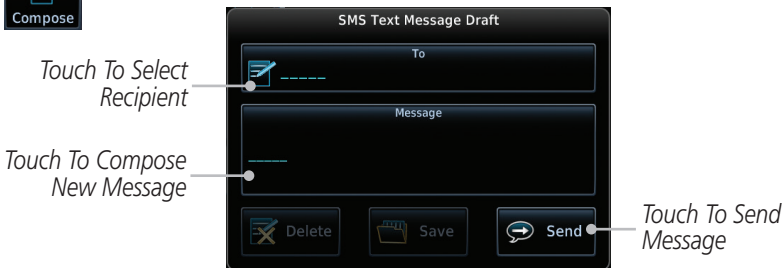

Figure 14-23 Compose a New SMS Text Message

2. Touch the **To** window to select the recipient. Select either a Phone Number or E-mail Address.

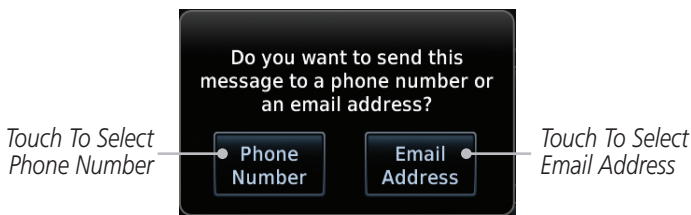

Figure 14-24 Select Destination for the SMS Text Message

- Use either the keypad or select from the Contacts.
- Touch the **Message** window to enter the text for the message. Use the keypad to create the message.
- Touch **Send** to send the message. Touch **Save** to save the message as a draft. Touch **Delete** to delete this message.



14.4.6.3 A Failed SMS Text Message

- While viewing the Services page, touch the **SMS Text** key and touch the Outbox tab. A failed message is noted with an "X."

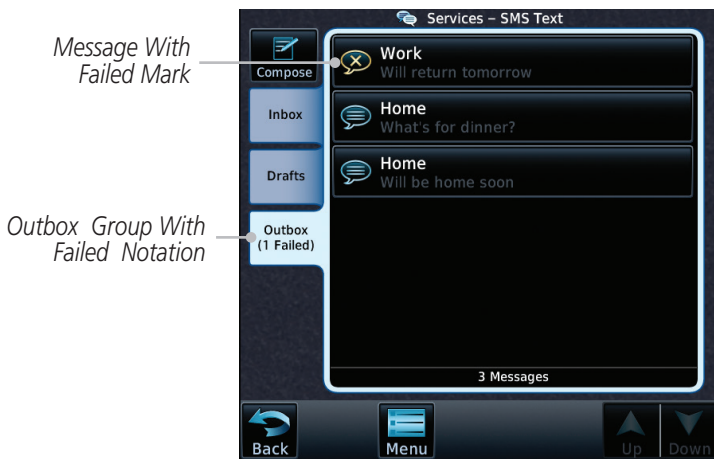
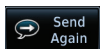

Figure 14-25 SMS Text Message List Showing a Failed Message

- Touch the failed message. Touch the **Send Again** key to resend the message. Touch the **Delete** key to delete the message.



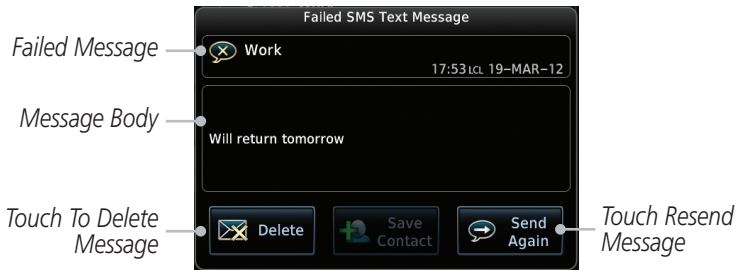

Figure 14-26 Resend a Failed SMS Text Message

14.4.7 Position Reporting

Position Reporting is a system which collects system variables and transmits them over the Iridium® satellite at a given interval through the GSR 56.



1. While viewing the Services page, touch the **Position Reports** key.

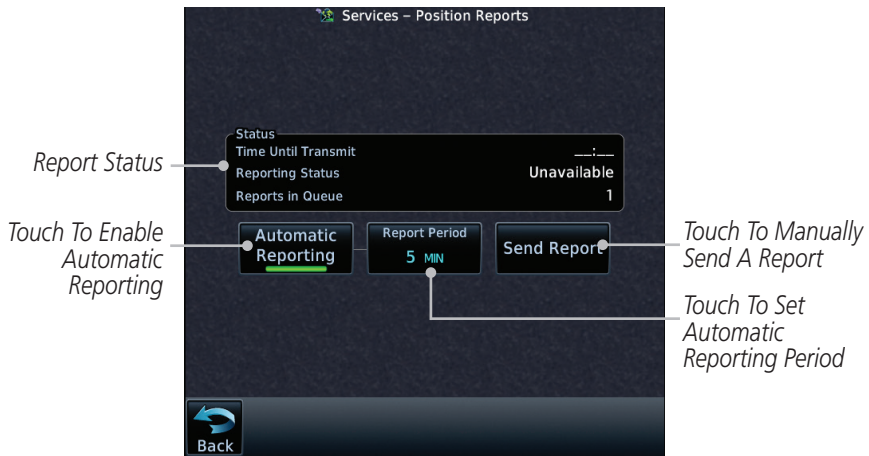
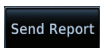

Figure 14-27 Services Position Reporting



2. Touch the **Automatic Reporting** key to enable Automatic Reporting.



3. After Automatic Reporting is enabled, touch the **Report Period** key to set the Reporting Period.



4. Select the Report Period with the keypad and press **Enter**.



5. When Automatic Reporting is disabled, touch the **Send Report** key to manually send a report.

14.4.7.1 Status

The Status window shows the time until the next data transmission and the status of the reporting system.



NOTE: *The GSR 56 does not report its serial number until 90 seconds after power up of the GTN. As a result, for that period, the product info for the GSR 56 will show "Waiting."*

14.4.7.2 Position Reporting Status

The Time Until Transmit field is a countdown timer that shows the time until the next data transmission. This field is blank when the aircraft is on the ground. Position Reporting will be enabled when the aircraft is in the air.

Status	Description
Idle	The reporting system is not using the GSR 56 for reporting at this time.
Initializing	The GSR 56 and its driver are currently initializing.
Transferring	A position report is currently being transmitted.
Unavailable	The GSR 56 is currently not usable by the reporting system.

Table 14-3 Position Reporting Status



Figure 14-28 Position Reporting Status

14.4.8 Contacts

The Phone Book may hold up to 128 entries. A phone number may be entered and dialed without saving it to the Phone Book. Note that it is necessary to dial a “1,” the area code, and then the number.

14.4.8.1 Creating a Contact



1. While viewing the Services page, touch the **Contacts** key.

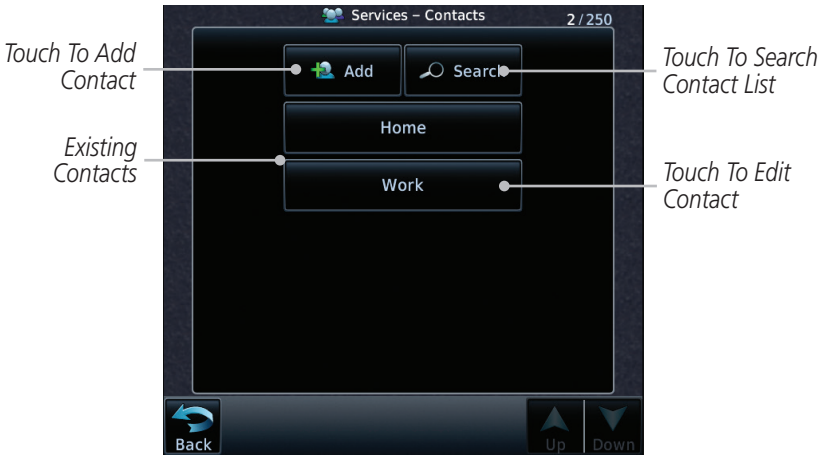

Figure 14-29 Contact List



2. Touch the **Add** key to add a new contact.

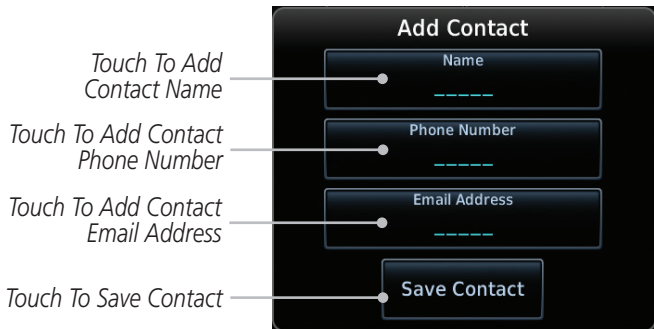

Figure 14-30 Add a New Contact



3. Use the keypad to enter the information for each item and then touch the **Save Contact** key.

14.4.8.2 Using a Contact

1. While viewing the Contacts page, touch an existing contact.

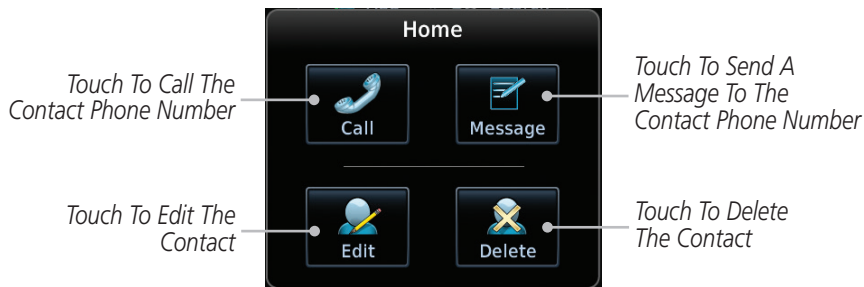

Figure 14-31 Using the Contact List

2. Touch the desired function for the selected Contact.

15 UTILITIES

The Utilities page provides a group of features that make flight planning easier and more efficient.



Figure 15-1 Utilities Page

Feature	Description
VNAV ¹	<ul style="list-style-type: none"> • Enable en route vertical guidance • Specify a target vertical speed and flight path angle • View active constraint data
VCALC ¹	Calculate time to TOD and vertical speed required to reach target altitude at the specified location.
Trip Planning	View DTK, DIS, ETE, ESA and ETA information for a direct-to, point-to-point between two specified waypoints or for any programmed flight plan.
Fuel Planning ²	View fuel conditions along the active direct-to or flight plan.
DALT/TAS/Winds	Calculate altitude, airspeed, and winds.
RAIM Prediction	Determine GPS coverage availability for the current location or a specified waypoint at any time and date. RAIM performs checks to ensure the GTN unit has adequate satellite geometry during flight.
Flight Timers	Monitor time in flight using three available timer types.

Foreword
Getting Started
Audio & Xpdr Ctrl
Com/Nav
FPL
Direct-To
Proc
Charts
Wpt Info
Map
Traffic
Terrain
Weather
Nearest
Services/ Music
Utilities
System
Messages
Symbols
Appendix

Feature	Description
Scheduled Messages	Create custom reminder messages and set when they will display.
Checklists	Review a built-in version of the aircraft checklist.
Logs	Export a flight data log.
Clean Screen	Lock touchscreen controls to prevent accidental activation while cleaning the display.

Table 15-4 Utilities Page Features

Note 1: VCalc and VNAV functions are mutually exclusive. Enabling one automatically disables the other.

Note 2: Aircraft must be equipped with fuel flow and/or fuel on board sensors.

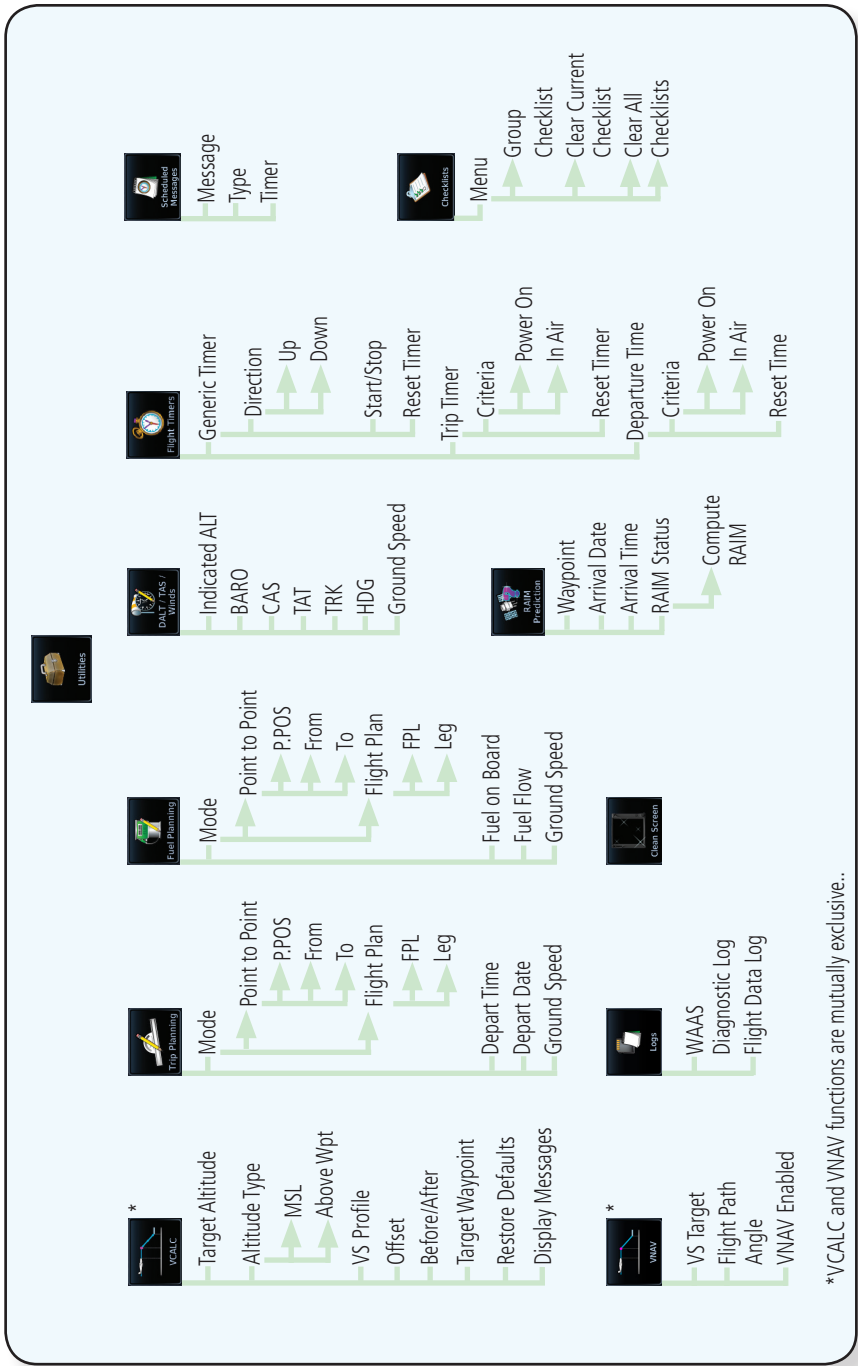

*V-CALC and VNAV functions are mutually exclusive..

Figure 15-2 Utilities Functional Diagram

15.1 Vertical Calculator (VCALC)



NOTE: If VNAV is enabled, this page is replaced with the VNAV Profile page. For more information, refer to section 4.3.3.

The Vertical Calculator (VCALC) function allows you to create a three-dimensional profile which guides you from your present position and altitude to a final (target) altitude at a specified location. This is helpful when you would like to descend to a certain altitude near an airport. Once the profile is defined, message alerts and additional data can be configured on the Map Page to keep you informed of your progress.



Figure 15-3 VCALC Target

VCALC is inhibited in the following conditions:

- Groundspeed is less than 35 knots
- No active flight plan or direct-to destination
- SUSP mode
- Vectors-to-Final mode
- VLOC mode
- After the FAF on an approach
- OBS mode



WARNING: Do not use VCALC messages as the only means of either avoiding terrain/obstacles or following ATC guidance. VCALC provides advisory information only and must be used in concert with all other available navigation data sources.

- Foreword
- Getting Started
- Audio & Xpdr Ctrl
- Com/Nav
- FPL
- Direct-To
- Proc
- Charts
- Wpt Info
- Map
- Traffic
- Terrain
- Weather
- Nearest
- Services/Music
- Utilities
- System
- Messages
- Symbols
- Appendix
- Index

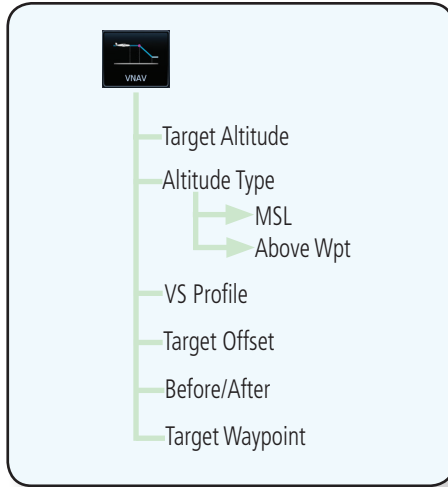

Figure 15-4 VCalc Page Functional Diagram



1. From the Utilities page, touch **VCalc**.

Figure 15-5 VCalc Page



2. Select the VCalc items as necessary to set up parameters for the next waypoint. Touch the **Back** key when finished.

15.1.1 Target Altitude

This sets the desired ending altitude for the VCALC setup.

1. While viewing the VCALC page, touch **Target ALT**.

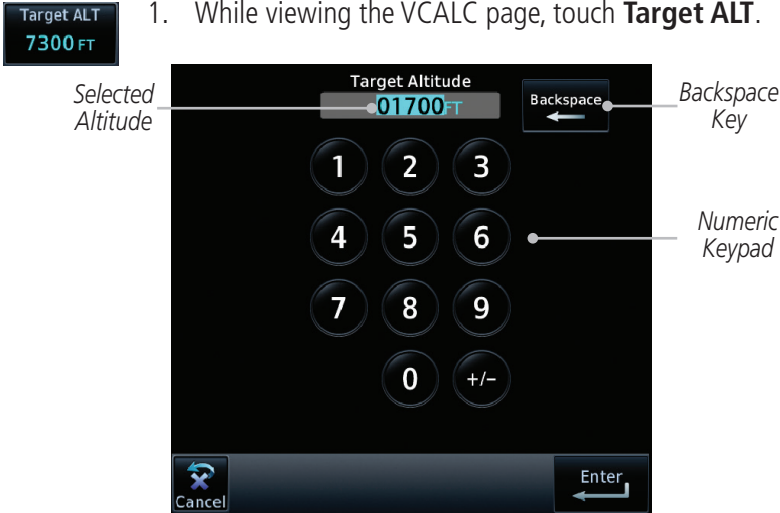

Figure 15-6 Select VCALC Target Altitude

2. Use the numeric keypad to select the desired Target Altitude and then touch the **Enter** key.

15.1.2 Altitude Type

This value selects the altitude reference that will be used for VCALC calculations.

1. While viewing the VCALC page, touch **Altitude Type**.
2. Touching the **Altitude Type** key will toggle between MSL and Above WPT. "Above WPT" is only available for waypoints that are airports.

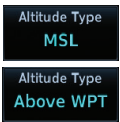

15.1.3 Vertical Speed (VS) Profile

This value sets the desired vertical speed.

VS Profile
200FM

1. While viewing the VCALC page, touch **VS Profile**.

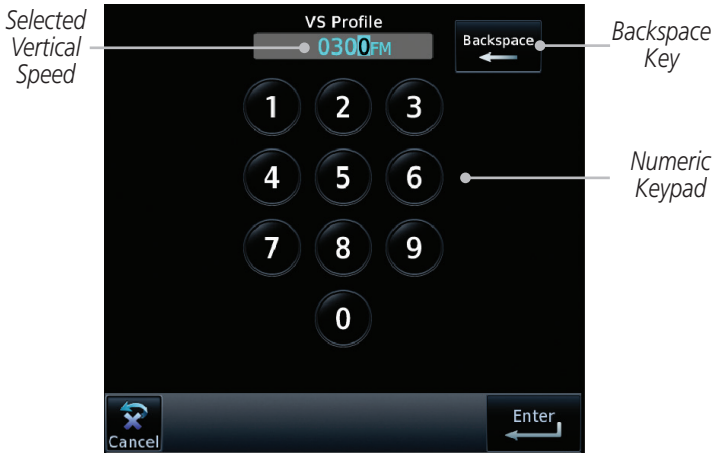

Figure 15-7 Select VCALC Vertical Speed

Enter

2. Use the numeric keypad to select the desired Vertical Speed and then touch the **Enter** key.

15.1.4 Target Offset

The Target Offset is a pilot-selected distance value that represents the geographical location where you wish to arrive at the target altitude. This distance is measured from the Target Waypoint and, in a separate data field on the VCALC page, designated as either before or after the Target Waypoint.



1. While viewing the VCALC page, touch the **Offset** key.



Figure 15-8 Select VCALC Target Offset



2. Use the numeric keypad to select the desired Target Offset and then touch the **Enter** key.

15.1.5 Before/After Target Waypoint

This setting designates whether the offset distance defines a point before you reach the target reference waypoint or after you reach the waypoint. The “After” selection is not available for the last waypoint in a flight plan.



1. While viewing the VCALC page, touch the **Before/After** key.



2. Touching the **Before/After** key will toggle between Before and After the Target Waypoint.

15.1.6 Target Waypoint

Select the waypoint in the flight plan that will be used for planning a descent. When using a flight plan, the target waypoint is a reference that can be specified from the waypoints contained in the flight plan. By default, the last waypoint in the flight plan is selected.



1. While viewing the VCALC page, touch **Target Waypoint**.



Figure 15-9 Select VCALC Target Waypoint List

2. A list of the remaining waypoints in the flight plan will be shown. Touch the desired waypoint to select it as the Target Waypoint.

15.1.7 Display VCALC Messages

Selecting **Display Messages** will allow the display of messages about the VCALC function when they occur. With **Display Messages** not selected, VCALC messages will not be displayed.

Display Messages

1. While viewing the VCALC page, touch **Display Messages** to toggle the display of VCALC messages in the Message function.

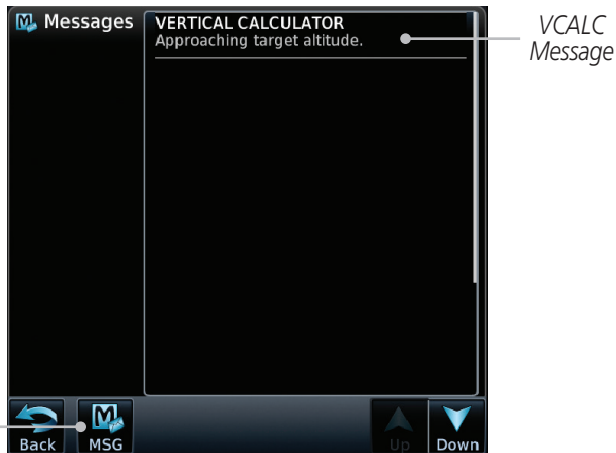

Figure 15-10 VCALC Approaching Target Altitude Message

2. Touch the **MSG** key to toggle the display of available messages.



15.1.8 Restore VCALC Defaults

While viewing the VCALC page menu, touching the **Restore Defaults** key will reset all of the VCALC values back to their default values. The Target Waypoint will not be changed.

15.2 Flight Timers

The Flight Timers function provides count up/down timers, plus automatic recording of departure time, and total trip time. Departure and total trip time recording can be configured to run either any time unit power is on, or only when your ground speed exceeds the in-air threshold set by the installer (for example, 30 knots). A flexible Generic Timer is available for general timing needs.



NOTE: When a count up timer is used, the preset value has no function.



1. While viewing the Utilities page, touch the **Flight Timers** key.

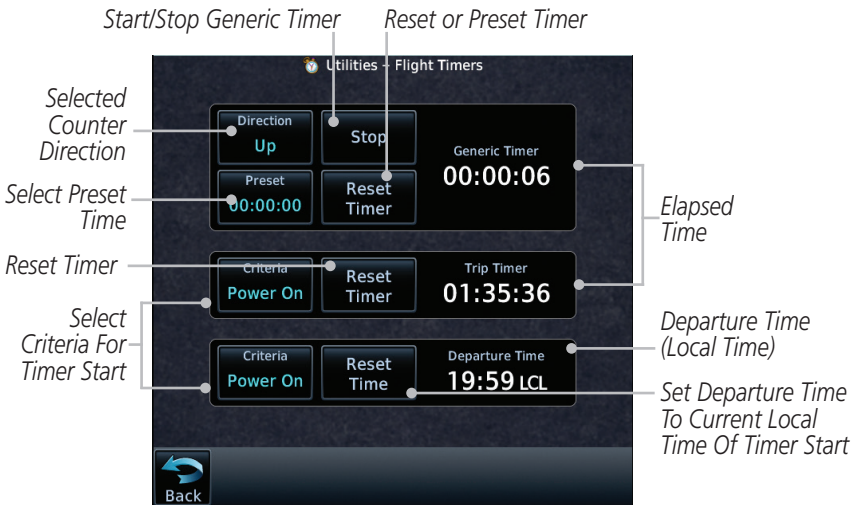

Figure 15-11 Utility Flight Timers Page

2. If the Generic Timer Direction counter is set to "Up," the Reset Timer key will be shown and when touched will return the timer to 00:00:00. If the Direction counter is set to "Down," the Preset Timer key will be shown and the key will return the timer to the Preset time value.
3. Touch each key as desired to set up timer operation.

15.3 RAIM Prediction

RAIM Prediction predicts if GPS coverage is available for your current location or at a specified waypoint at any time and date. RAIM performs checks to ensure that the GTN unit has adequate satellite geometry during your flight. RAIM availability is near 100% in Oceanic, En Route and Terminal phases of flight. Because the FAA's TSO requirements for non-precision approaches specify significantly better satellite coverage than other flight phases, RAIM may not be available when flying some approaches. The GTN unit automatically monitors RAIM during approach operations and warns you if RAIM is not available. In such cases, use a non-GPS based approach. RAIM prediction helps you plan for a pending flight to confirm GPS operation during an approach.

RAIM prediction only predicts the availability of Fault Detection (FD) integrity in the absence of SBAS corrections. It cannot predict the availability of LPV or L/VNAV approaches. The FAA provides a NOTAM service for LPV approach availability.

1. While viewing the Utilities page, touch the **RAIM Prediction** key.



Touch To Select Destination Waypoint

Touch To Select Local Arrival Time
Touch To Select Local Arrival Date

Figure 15-12 Utility RAIM Prediction Page

2. Touch the **Waypoint** key and select the waypoint for RAIM Prediction.
3. Touch the **Arrival Date** key and select the date of arrival at the selected waypoint.

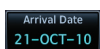

Arrival Time
22:18 LCL

4. Touch the **Arrival Time** key and select the local time of expected arrival at the selected waypoint.
5. When the Waypoint, Arrival Date, and Arrival Time values have been entered, touch the **Compute RAIM** key to determine if RAIM is available.

Compute RAIM

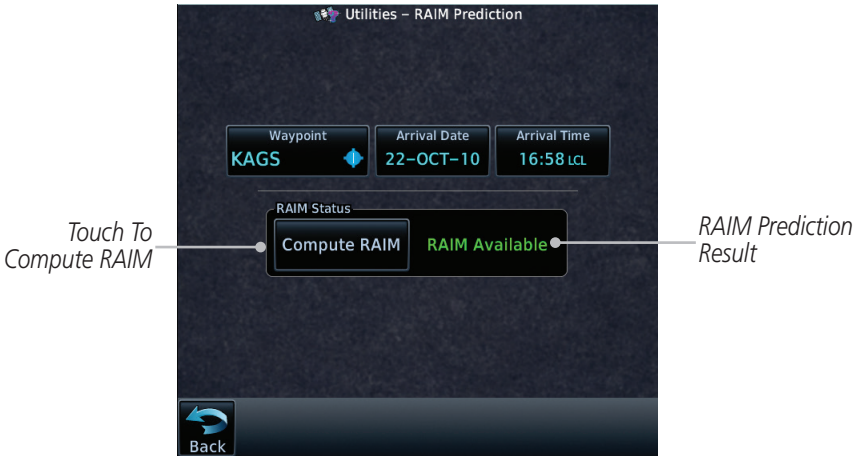

Figure 15-13 RAIM Prediction Completed

15.4 Trip Planning

The GTN 7XX allows the pilot to view desired track (DTK), distance (DIS), estimated time en route (ETE), en route safe altitude (ESA) and estimated time of arrival (ETA) information for a direct-to, point-to-point between two specified waypoints or for any programmed flight plan. This item also displays the sunrise/sunset times for your destination waypoint (for the selected departure date). All times are based on the time set in System-Setup. For trip planning inputs: departure time and date are manually entered, while ground speed can be provided by sensor data, if selected.

The trip statistics are calculated based on the selected starting and ending waypoints and the trip planning inputs.

In Flight Plan mode with a stored flight plan selected, and the entire flight plan (CUM) selected, the waypoints are the starting and ending waypoints of the selected flight plan.

In Flight Plan mode with a stored flight plan selected, and a specific leg selected, the waypoints are the endpoints of the selected leg.

In Point-To-Point mode these are manually selected waypoints (if there is an active flight plan, these default to the endpoints of the active leg).

Some of the calculated trip statistics are dashed when the selected leg of the active flight plan has already been flown.

- Desired Track (DTK) - DTK is shown as nnn° and is the desired track between the selected waypoints. It is dashed unless only a single leg is selected.
- Distance (DIS) - The distance is shown in tenths of units up to 99.9, and in whole units up to 9999.
- Estimated time en route (ETE) - ETE is shown as hours:minutes until less than an hour, then it is shown as minutes:seconds.
- Estimated time of arrival (ETA) - ETA is shown as hours:minutes and is the local time at the destination.
 - If in Point-To-Point mode then the ETA is the ETE added to the departure time.
 - If a flight plan other than the active flight plan is selected it shows the ETA by adding to the departure time all of the ETEs of the legs up to and including the selected leg. If the entire flight plan is selected, then the ETA is calculated as if the last leg of the flight plan was selected.
 - If the active flight plan is selected the ETA reflects the current position of the aircraft and the current leg being flown. The ETA is calculated by adding to the current time the ETEs of the current leg up to and including the selected leg. If the entire flight plan is selected, then the ETA is calculated as if the last leg of the flight plan was selected.
- En Route safe altitude (ESA) - The ESA is shown as nnnnnFT.
- Destination sunrise and sunset times - These times are shown as hours:minutes and are the local time at the destination.



NOTE: *The capability of using Sensor Data for the trip planning functions is available in software v2.00, v4.10, and later.*

- Foreword
- Getting Started
- Audio & Xpdr Ctrl
- Com/Nav
- FPL
- Direct-To
- Proc
- Charts
- Wpt Info
- Map
- Traffic
- Terrain
- Weather
- Nearest
- Services/Music
- Utilities**
- System
- Messages
- Symbols
- Appendix
- Index

15.4.1 Point-To-Point Mode

The Trip Planning Point-to-Point mode shows trip calculations between two selected points: either two waypoints from the database or from your present position to a selected waypoint.



1. While viewing the Utilities page, touch the **Trip Planning** key.



2. Touch the **Mode** key to toggle to Point-to-Point.

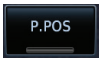

3. Touch the **P.POS** key to toggle between using your present position as the From waypoint when selected or a waypoint selected from the database when **P.POS** is deselected. If **P.POS** is selected, the Lat/Lon of the present position will be shown in the From position.

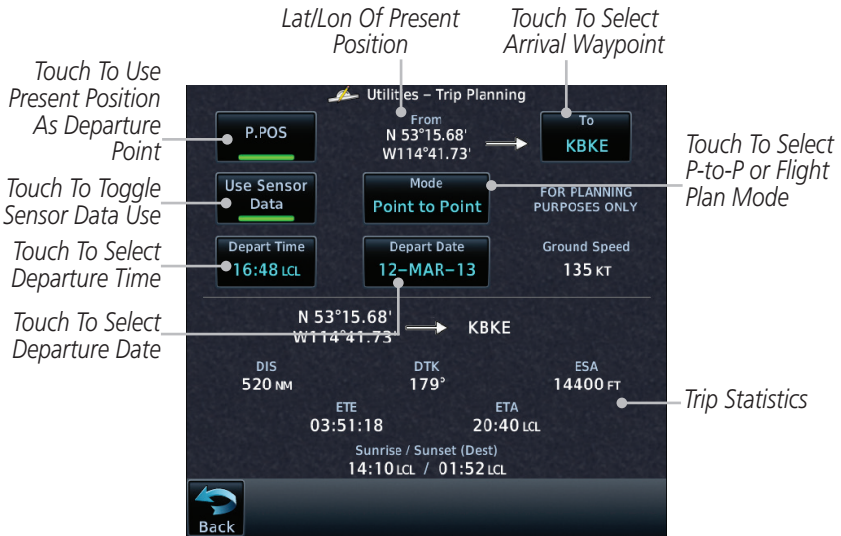

Figure 15-14 Utility Trip Planning Page (Point-To-Point Mode) - Sensor Data Used



4. If **P.POS** is not selected for the From point, touch the **From** key and then use the keypad to select a waypoint from the database and touch **Enter**.

Foreword
Getting Started
Audio & Xpdr Ctrl
Com/Nav
FPL
Direct-To
Proc
Charts
Wpt Info
Map
Traffic
Terrain
Weather
Nearest
Services/Music
Utilities
System
Messages
Symbols
Appendix
Index



Figure 15-15 Selecting a From Waypoint

5. Touch the **To** key and then use the keypad to select a waypoint from the database for the destination waypoint and touch **Enter**.
6. Touch the **Depart Time** key and then use the keypad to select the departure time (local time at From waypoint) and touch **Enter**.

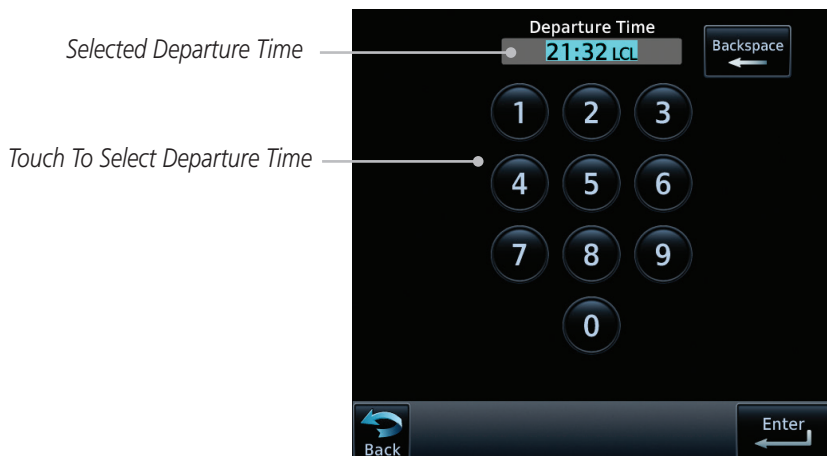
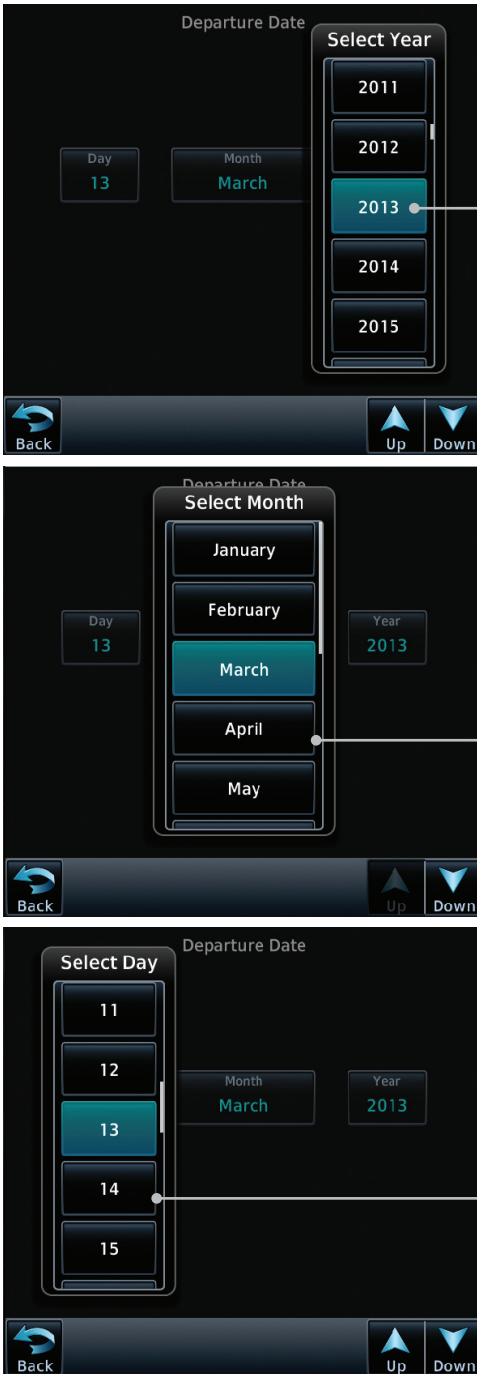

Figure 15-16 Selecting Departure Time

7. Touch the **Depart Date** key and then the Departure Date page to select the departure year, month, and day and then touch **Enter**.





*Touch To Select
Departure Year*

*Touch To Select
Departure Month*

*Touch To Select
Departure Day*

Figure 15-17 Selecting Departure Date

Foreword

Getting Started

Audio & Xpdr Ctrl

Com/Nav

FPL

Direct-To

Proc

Charts

Wpt Info

Map

Traffic

Terrain

Weather

Nearest

Services/
Music

Utilities

System

Messages

Symbols

Appendix

Foreword

Ground Speed
120 kt

8. Touch the **Ground Speed** key and then the keypad to select the average ground speed for the trip and touch **Enter**.

Getting Started

Selected Ground Speed

Audio & Xpdr Ctrl

Touch To Select Ground Speed

Com/Nav



FPL

Direct-To

Proc

Charts

Figure 15-18 Selecting Expected Average Ground Speed

Wpt Info

Compute Data

9. After completing the Trip Planning selections, the trip statistics will be shown in the lower half of the display.

Map

Traffic

Terrain

Weather

Nearest

Services/
Music



Trip Statistics For Selected Route

Figure 15-19 Utility Trip Planning Page With Computed Data (Point-To-Point Mode)

System

Messages

Symbols

Appendix

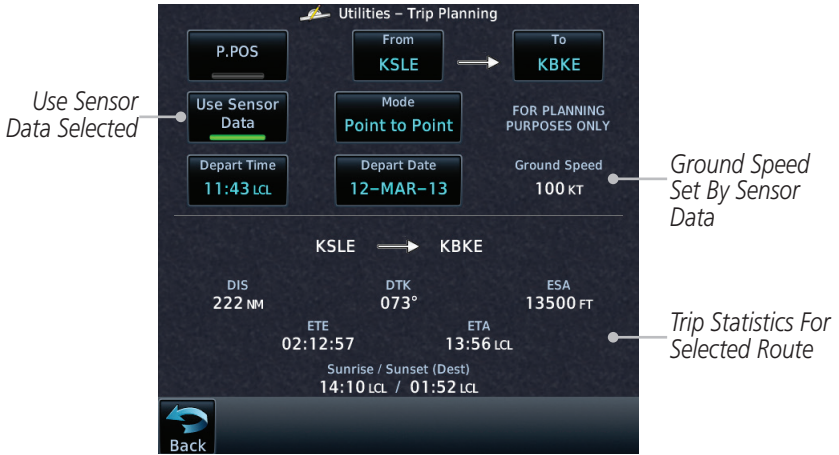

Figure 15-20 Utility Trip Planning Page With Computed Data (Point-To-Point Mode) - Use Sensor Data Selected



NOTE: When Local Time is selected in the Setup-Date/Time feature, Sunrise/Sunset calculations in the Trip Planning feature are based on the From waypoint time zone. For instance, a flight plan originating in the Pacific time zone and ending in the Central time zone would show Sunset/Sunrise times at the destination in Pacific time. This potential offset does not occur when UTC time is used.

- Foreword
- Getting Started
- Audio & Xpdr Ctrl
- Com/Nav
- FPL
- Direct-To
- Proc
- Charts
- Wpt Info
- Map
- Traffic
- Terrain
- Weather
- Nearest
- Services/Music
- Utilities**
- System
- Messages
- Symbols
- Appendix

15.4.2 Flight Plan Mode

The Trip Planning Flight Plan mode shows trip calculations between two legs of the flight plan or the cumulative flight plan.

1. Touch the **Mode** key to select Flight Plan mode, if required.

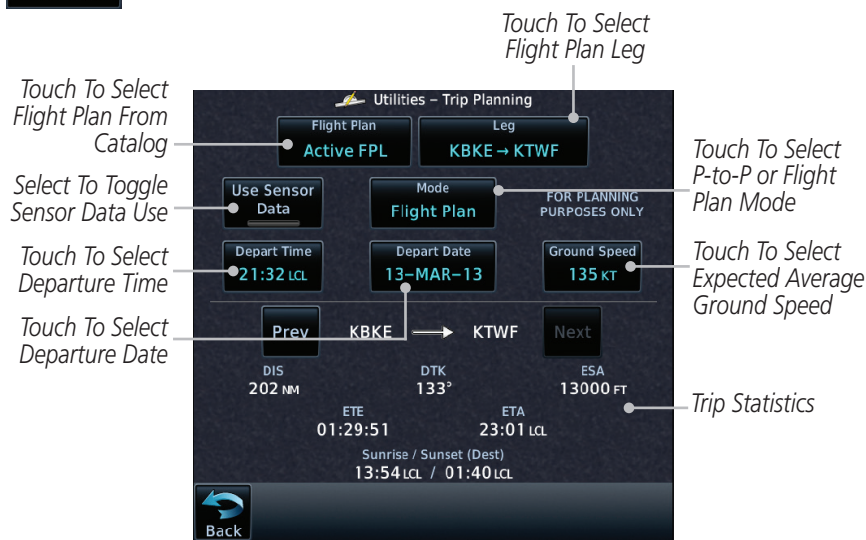

Figure 15-21 Utility Trip Planning Page (Flight Plan Mode)

2. Touch the **Flight Plan** key to select the flight plan.



Figure 15-22 Select Flight Plan

Leg
KBKE → KTWf

3. Touch the **Leg** key to select the flight plan leg. If the “Cumulative” selection is chosen, statistics will relate to the entire flight plan.



Touch To Select Flight Plan Leg (Cumulative FPL Shown)

Figure 15-23 Select Flight Plan Leg

Depart Time
21:36 LCL

4. Touch the **Depart Time** key and then use the keypad to select the departure time (local time at From waypoint) and touch **Enter**.

Depart Date
23-NOV-10

5. Touch the **Depart Date** key and then the Departure Date page to select the departure year, month, and day and then touch **Enter**.

Ground Speed
120 KT

6. Touch the **Ground Speed** key and then the keypad to select the average ground speed for the trip and touch **Enter**.

- Foreword
- Getting Started
- Audio & Xpdr Ctrl
- Com/Nav
- FPL
- Direct-To
- Proc
- Charts
- Wpt Info
- Map
- Traffic
- Terrain
- Weather
- Nearest
- Services/Music
- Utilities**
- System
- Messages
- Symbols
- Appendix

- Statistics for the current flight plan leg are displayed in the lower half of the display.

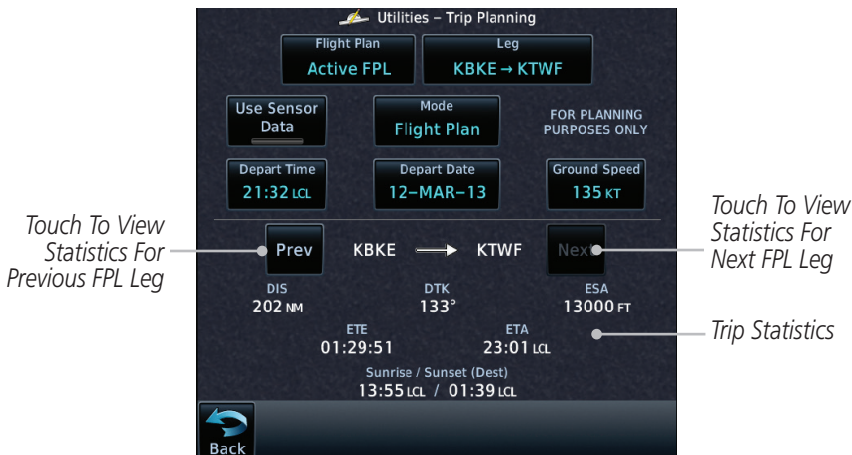

Figure 15-24 Utility Trip Planning Page Computed Data View (Flight Plan Mode)



Figure 15-25 Utility Trip Planning Page Computed Data View (Flight Plan Mode) - Use Sensor Data Selected



- Touch the **Next** key to view statistics for the next leg in the flight plan.

15.5 Fuel Planning

Fuel Planning — This item displays fuel conditions along the active direct-to or flight plan. You may manually enter fuel flow, ground speed (GS) and fuel on board figures for planning purposes. Fuel planning figures can be displayed not only for the currently active flight plan or direct-to, but also point-to-point between two specified waypoints and for any programmed flight plan.

Fuel on board and fuel flow may be manually entered in the unit start-up sequence and used to recalculate fuel on board as it is consumed. When fuel flow or fuel on board is manually entered, the figures are retained the next time you view the page (with fuel on board continuously recalculated).



NOTE: The capability of using Sensor Data for the trip planning functions is available in software v2.00, v4.10, and later.

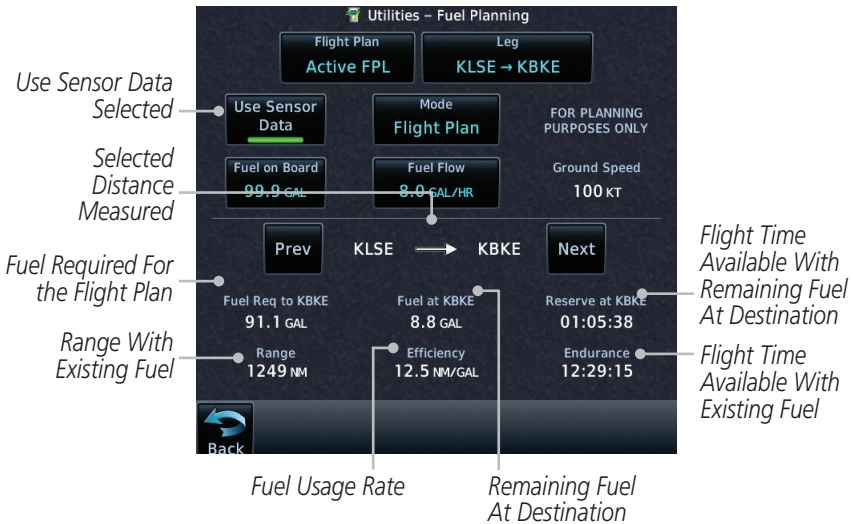

Figure 15-26 Utility Fuel Planning Page (Flight Plan Mode) - Use Sensor Data Selected

15.5.1 Point-To-Point Mode

The Fuel Planning Point-to-Point mode shows fuel calculations between two selected points: either two waypoints from the database or from your present position to a selected waypoint.



1. While viewing the Utilities page, touch the **Fuel Planning** key.



2. Touch the **Mode** key to toggle to Point-to-Point.

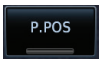

3. Touch the **P.POS** key to toggle between using your present position as the From waypoint when selected or a waypoint selected from the database when **P.POS** is deselected. If **P.POS** is selected, the Lat/Lon of the present position will be shown in the From position.

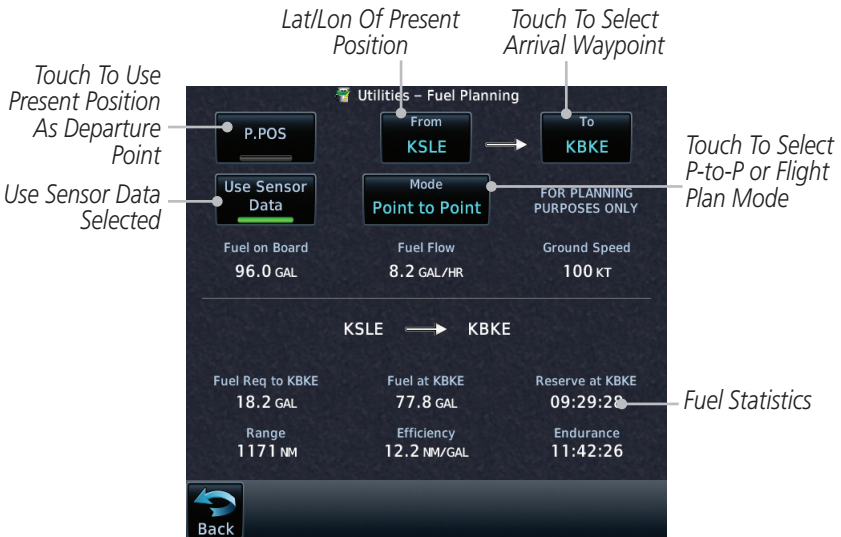

Figure 15-27 Utility Trip Planning Page (Point-To-Point Mode) - Use Sensor Data Selected



4. If **P.POS** is not selected for the From point, touch the **From** key and then use the keypad to select a waypoint from the database and touch **Enter**.



Figure 15-28 Selecting the From Waypoint



5. Touch the **To** key and then use the keypad to select a waypoint from the database for the destination waypoint and touch **Enter**.



6. Touch the **Fuel on Board** key and then use the keypad to select the current amount of fuel on board and touch **Enter**.

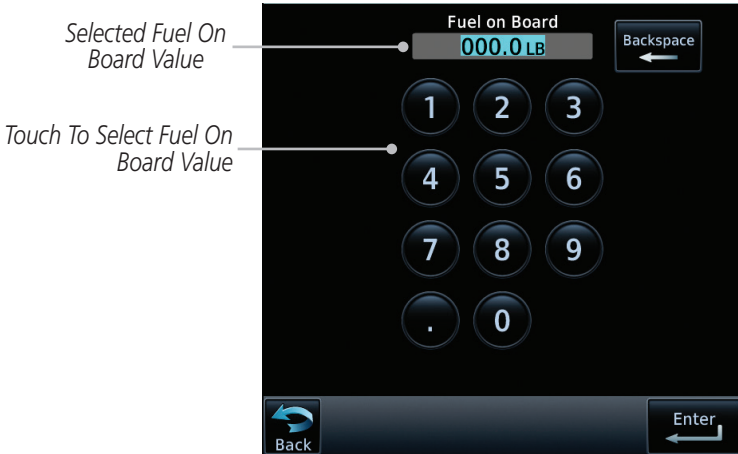

Figure 15-29 Selecting Current Fuel On Board

Foreword

Fuel Flow
500.0 LB/HR

7. Touch the **Fuel Flow** key and then use the keypad to select the average fuel flow and touch **Enter**.

Getting Started

Audio & Xpdr Ctrl

Com/Nav

FPL

Direct-To

Proc

Charts

Wpt Info

Map

Traffic

Terrain

Weather

Nearest

Services/
Music

Utilities

System

Messages

Symbols

Appendix

Index

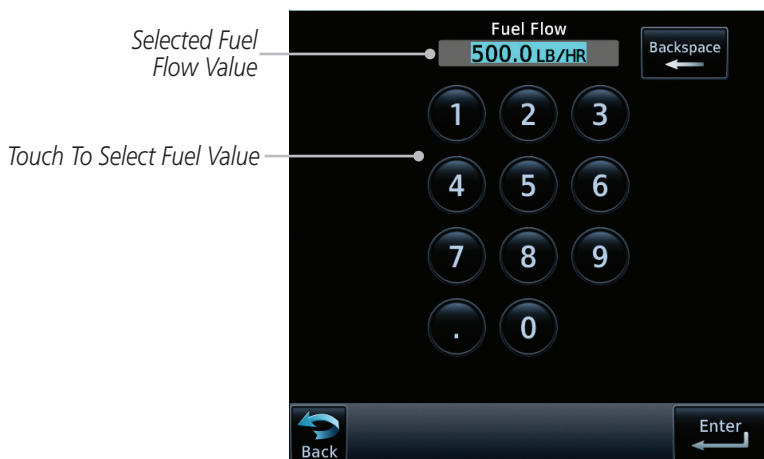

Figure 15-30 Selecting Fuel Flow

8. Touch the **Ground Speed** key and then the keypad to select the average ground speed for the trip and touch **Enter**.

Ground Speed
120 KT

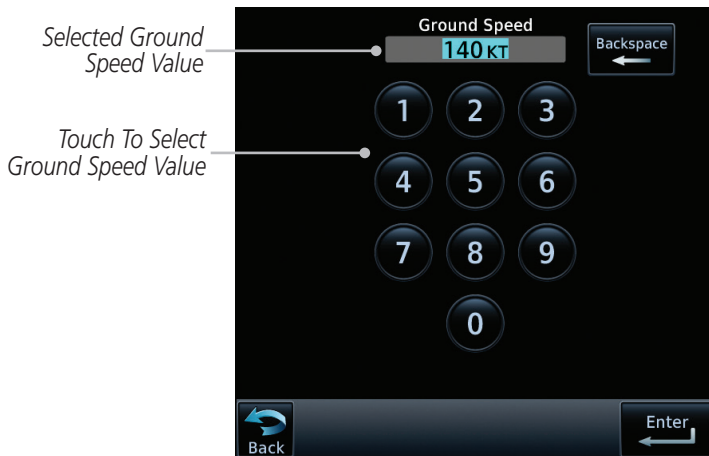

Figure 15-31 Selecting Ground Speed

15.5.2 Flight Plan Mode

The Fuel Planning Flight Plan mode shows fuel calculations between two legs of the flight plan or the cumulative flight plan.

Mode
Point to Point

1. Touch the **Mode** key to select Flight Plan mode, if required.

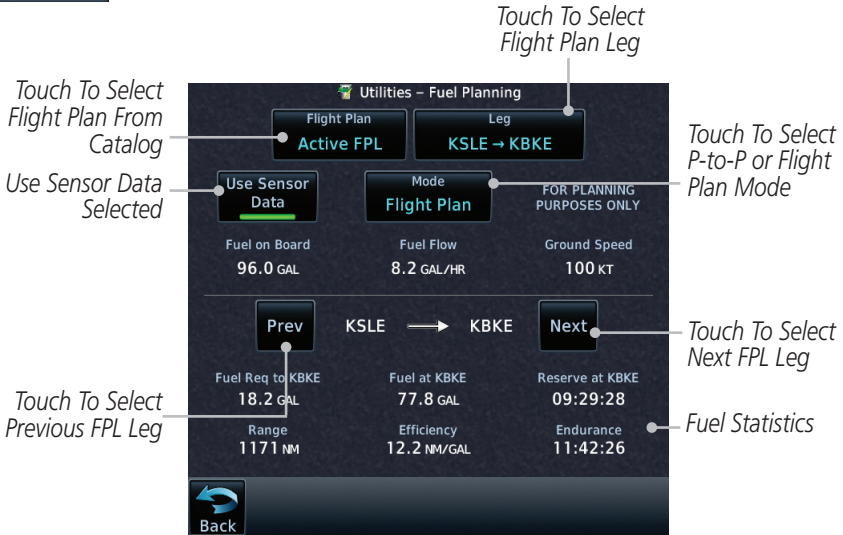

Figure 15-32 Utility Fuel Planning Page (Flight Plan Mode)

Flight Plan
Active FPL

2. Touch the **Flight Plan** key to select the flight plan.



Figure 15-33 Select Flight Plan

Foreword
Getting Started
Audio & Xpdr Ctrl
Com/Nav
FPL
Direct-To
Proc
Charts
Wpt Info
Map
Traffic
Terrain
Weather
Nearest
Services/Music
Utilities
System
Messages
Symbols
Appendix

Foreword
Getting Started
Audio & Xpdr Ctrl
Com/Nav
FPL
Direct-To
Proc
Charts
Wpt Info
Map
Traffic
Terrain
Weather
Nearest
Services/ Music
Utilities
System
Messages
Symbols
Appendix
Index

Leg
KBKE → KTWF

3. Touch the **Leg** key to select the flight plan leg. If the “Cumulative” selection is chosen, statistics will relate to the entire flight plan.



Touch To Select Flight Plan Leg (Cumulative FPL Shown)

Figure 15-34 Select Flight Plan Leg

Fuel on Board
2615.3 LB

Fuel Flow
500.0 LB/HR

Ground Speed
120 KT

4. If desired, touch the **Fuel on Board** key and then use the keypad to select the Fuel on Board value and touch **Enter**.
5. If desired, touch the **Fuel Flow** key and then use the keypad to select the Fuel Flow value and touch **Enter**.
6. Touch the **Ground Speed** key and then the keypad to select the average ground speed for the trip and touch **Enter**.
7. Statistics for the current flight plan leg are displayed in the lower half of the display. The Cumulative flight plan is shown.
8. Touch the **Previous** and **Next** keys to view statistics for the previous and next legs in the flight plan.

Prev

Next

15.6 DALT/TAS/Winds

Density Alt / TAS / Winds — indicates the theoretical altitude at which your aircraft performs depending upon several variables, including indicated altitude (Indicated ALT), barometric pressure (BARO) and total air temperature (TAT; the temperature, including the heating effect of speed, read on a standard outside temperature gauge). This item computes true airspeed (TAS) and density altitude, based upon the factors above. Also, this feature determines winds aloft — the wind direction and speed — and a head wind/tail wind component, based on true airspeed, aircraft heading (HDG) and ground speed. When a FADC provides pressure altitude and the Use Sensor Data option is selected, the Baro key will not be present in the edit mode and the Baro indication will not be shown in computed results.

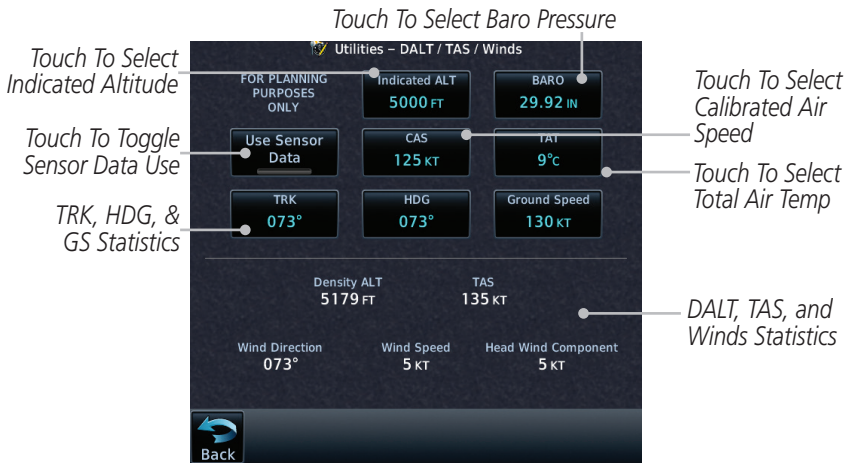

Figure 15-35 Utility DALT/TAS/Winds Page Using Indicated Altitude and Not Using Sensor Data

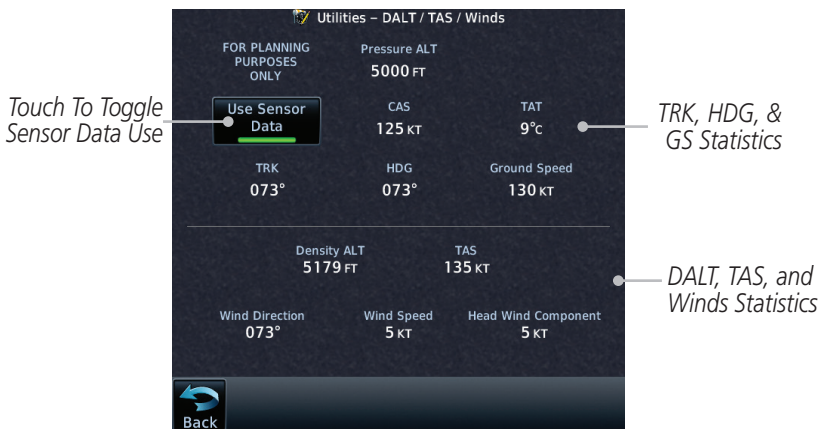

Figure 15-36 Utility DALT/TAS/Winds Page Using Sensor Data and Pressure Altitude



NOTE: The capability of using Sensor Data for the trip planning functions is available in software v2.00, v4.10, and later.

Foreword
Getting Started
Audio & Xpdr Ctrl
Com/Nav
FPL
Direct-To
Proc
Charts
Wpt Info
Map
Traffic
Terrain
Weather
Nearest
Services/Music
Utilities
System
Messages
Symbols
Appendix

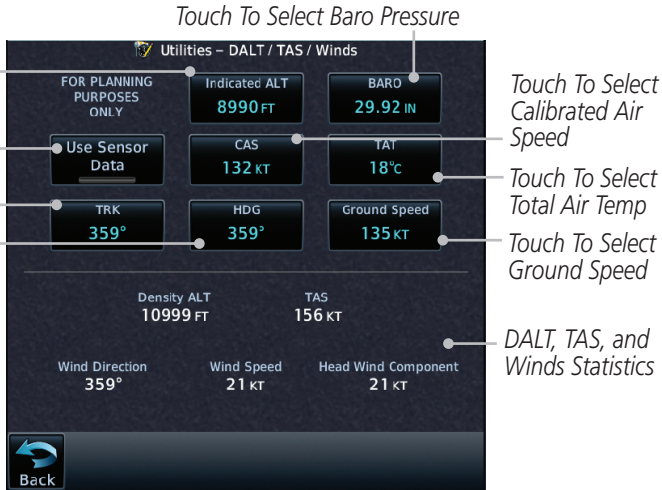

Figure 15-37 Utility DALT/TAS/Winds Page Using Manually Entered Data

1. Touch the **Indicated ALT** key and then the keypad to select the Indicated Altitude and then touch **Enter**.

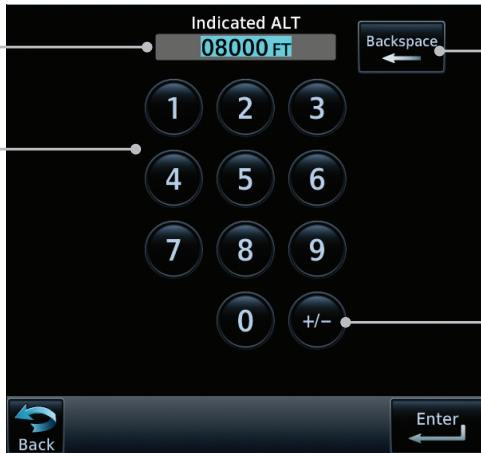

Figure 15-38 Select Indicated Altitude Value



2. Touch the **BARO** key and then the keypad to select the Barometric Pressure and then touch **Enter**.



Figure 15-39 Select Barometric Pressure Value

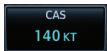

3. Touch the **CAS** key and then the keypad to select the Calibrated Air Speed and then touch **Enter**.



Figure 15-40 Select Calculated Air Speed Value

Foreword

TAT
15°C

4. Touch the **TAT** key and then the keypad to select the Total Air Temperature and touch **Enter**.

Getting Started

Audio & Xpdr Ctrl

Com/Nav

FPL

Direct-To

Proc

Charts

Wpt Info

Map

Traffic

Terrain

Weather

Nearest

Services/
Music

Utilities

System

Messages

Symbols

Appendix

Index



Figure 15-41 Select Total Air Temperature Value

TRK
122°

5. Touch the **TRK** key and then the keypad to select the Track Angle and then touch **Enter**.

Map

Traffic

Terrain

Weather

Nearest

Services/
Music

Utilities

System

Messages

Symbols

Appendix

Index



Figure 15-42 Select Track Angle Value



6. Touch the **HDG** key and then the keypad to select the Heading value and then touch **Enter**.

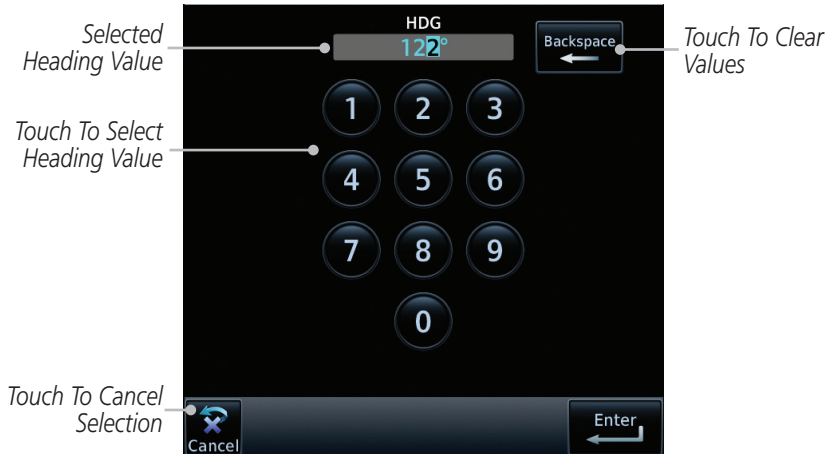

Figure 15-43 Select Heading Value



7. Touch the **Ground Speed** key and then the keypad to select the average ground speed for the trip and then touch **Enter**.

15.7 Clean Screen Mode

The Clean Screen mode makes the touchscreen inactive so the display can be manually cleaned. The front bezel, keypad, and display can be cleaned with a microfiber cloth or with a soft cotton cloth dampened with clean water. DO NOT use any chemical cleaning agents. Care should be taken to avoid scratching the surface of the display.

1. While viewing the Utilities page group, touch the **Clean Screen** key to start Screen Cleaning Mode.



Figure 15-44 Utilities Page

2. Touch the **HOME** key to exit Screen Cleaning Mode.

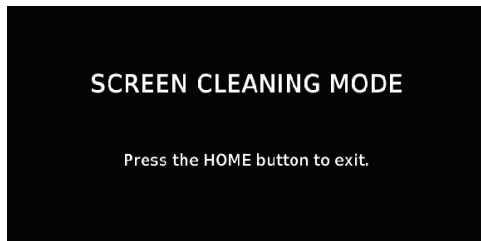

Figure 15-45 Screen Cleaning Mode

15.8 Scheduled Messages

The Scheduled Messages utility displays reminder messages (such as “Change oil,” “Switch fuel tanks,” “Overhaul,” etc.). One-time, periodic, and event-based messages are allowed. One-time messages appear once the timer expires and reappear each time the GTN-series unit is powered on, until the message is deleted. Periodic messages automatically reset to the original timer value, once the message is displayed. Event-based messages do not use a timer, but rather a specific date and time.



NOTE: This feature is available in software v5.00, and later.



1. While viewing the Utilities page group, touch the **Scheduled Messages** key to start the Scheduled Messages function.

Touch To Add A Scheduled Message

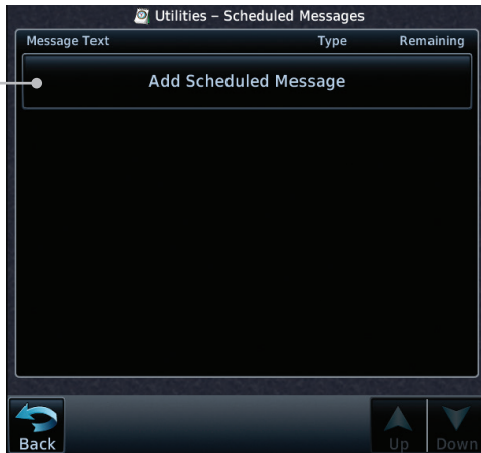

Figure 15-46 Scheduled Messages Page

- Touch the **Message** selection and enter the desired message to be displayed. Touch the **Type** selection to choose the message type. Touch the **Timer** selection to set the countdown time for the message to be displayed.

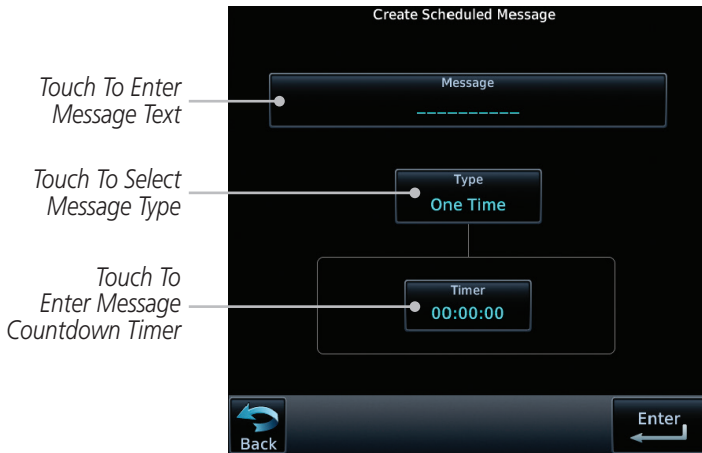

Figure 15-47 Create a Scheduled Message

- After completing the selections, touch the **Enter** key.

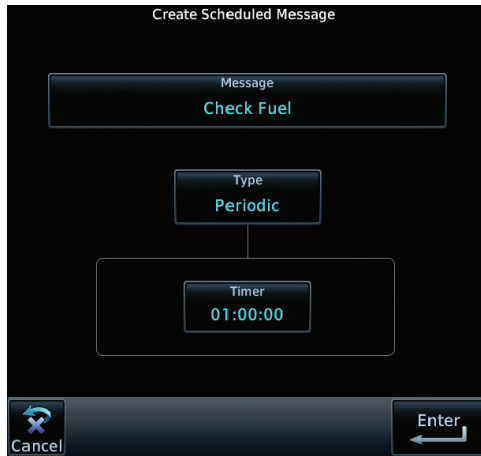

Figure 15-48 Sample Scheduled Message

15.9 Checklists

The Checklists function provides a built-in method of reviewing your aircraft checklist. Checklists are created using the Garmin Checklist Editor software (available online) and stored on the datacard as “chklist.ace.” As each Checklist is completed, you can advance to the next one in order. In the Checklist Menu, you can access any Checklist, or group of Checklists, and clear the current or all Checklists.



NOTE: This feature is available in software v5.10 and later. In software v6.00 and later, the installer may configure the title of this feature to be *Task Lists or Checklists*.

15.9.1 Checklists Menu



1. While viewing the Utilities page group, touch the **Checklists** key to start the Checklists function.



2. Touch the **Menu** key to select an option from the Checklist Menu.

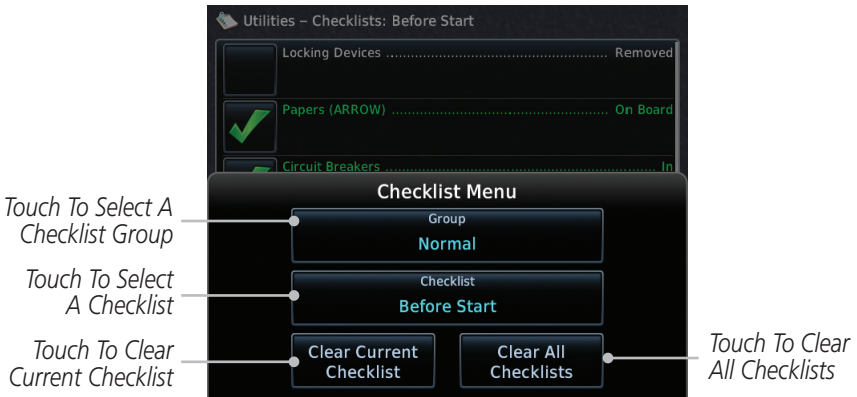

Figure 15-49 Utility Checklist Menu

Foreword
Getting Started
Audio & Xpdr Ctrl
Com/Nav
FPL
Direct-To
Proc
Charts
Wpt Info
Map
Traffic
Terrain
Weather
Nearest
Services/Music
Utilities
System
Messages
Symbols
Appendix
Index

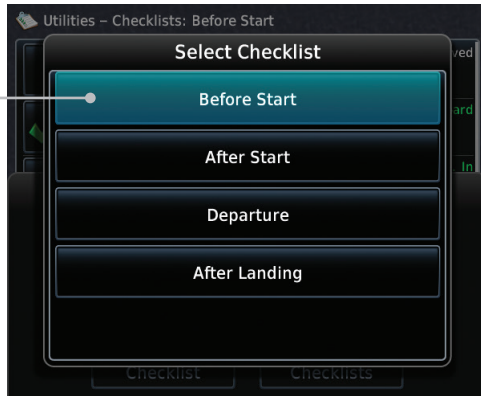

Figure 15-50 Select a Checklist from the Checklist Menu

15.9.2 Viewing Checklists



1. While viewing the Utilities function, touch the **Checklist** key. Use the existing Checklists in the order provided or touch the **Menu** key to select another checklist.

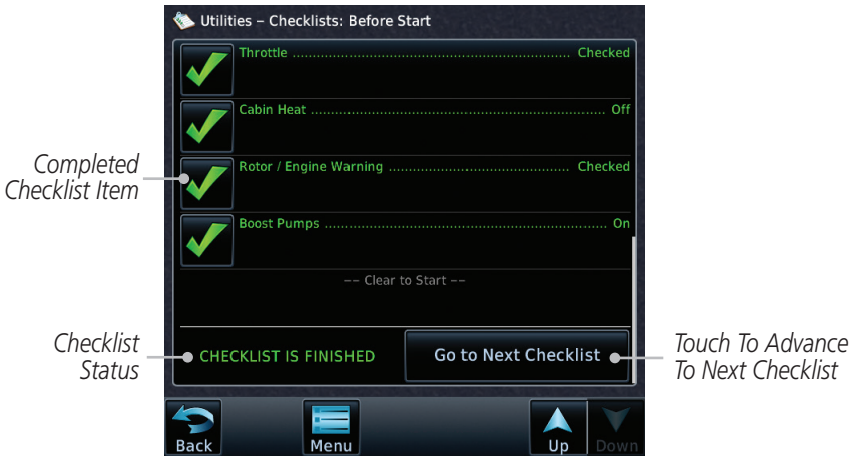

Figure 15-51 Checklist Completion

2. After completing the Checklist, touch **Go to Next Checklist**, **Menu**, or **Back** to exit the Checklist function.



NOTE: All checklists are cleared after a power cycle.

The System function allows you to change unit settings, customize operation to your preferences, and check on the operation of your unit. The System pages cover System Status, Database Info and transfer, GPS Status, External LRUs, Setup, Alerts, Units, Audio, Backlight control function, and Connex Setup.



1. From the Home page, touch the **System** key.



Figure 16-1 System Home Page



2. Touch the desired key to reach that function. To return to the System page, touch the **Back** key.

Foreword
 Getting Started
 Audio & Xpdr Ctrl
 Com/Nav
 FPL
 Direct-To
 Proc
 Charts
 Wpt Info
 Map
 Traffic
 Terrain
 Weather
 Nearest
 Services/ Music
 Utilities
System
 Messages
 Symbols
 Appendix



Figure 16-2 System Function Summary

16.1 System Status

The System status page of the System function provides information about the GTN unit and the equipment attached to it. This information is useful if it is necessary to contact Customer Service. The System Status page shows the System ID and serial number for the GTN unit, hardware and software versions, as well as a list of the installed databases.

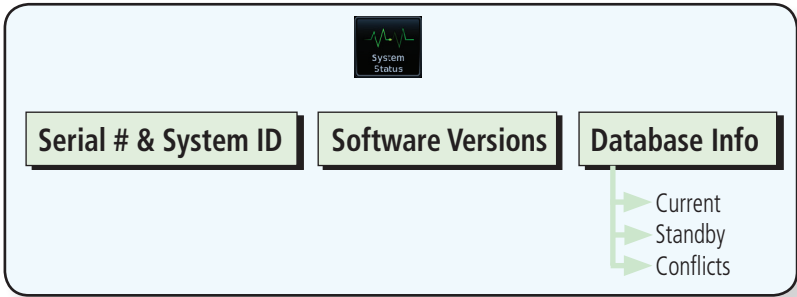

Figure 16-3 System Status Functional Diagram

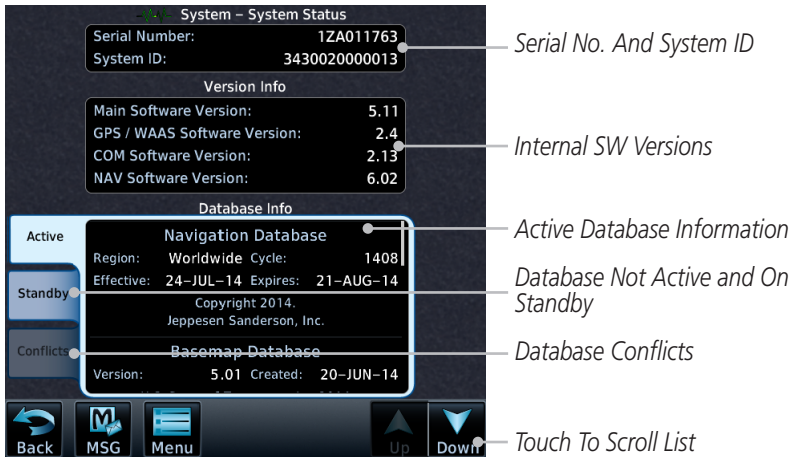

Figure 16-4 System Function System Status Page Description

Foreword

Getting Started

Audio & Xpdr Ctrl

Com/Nav

FPL

Direct-To

Proc

Charts

Wpt Info

Map

Traffic

Terrain

Weather

Nearest

Services/ Music

Utilities

System

Messages

Symbols

Appendix

Foreword



1. While viewing the System page, touch **System Status**.
2. Use the **Up** and **Down** arrow keys as needed to view the Database Information.
3. Touch the **Back** key to return to the System page.

Getting Started

Audio & Xpdr Ctrl



Com/Nav

16.1.1 Serial Number and System ID

FPL

The System Status section shows the unit Serial Number and the System ID.

Direct-To

16.1.2 Version Information

Proc

The software versions of the GTN unit are displayed. This information is useful when contacting Customer Support.

Charts

16.1.3 Database Information

Wpt Info

The Database Information section lists the name of the database, its version, and expiration date for the currently used databases, and also contains the Database SYNC function. Standby databases are listed for databases not currently used, but available on the datacard. Database conflicts will be shown in the Conflicts section. For more information on GTN databases and how to update them see section 19.2.

Map

Traffic

Terrain

16.2 GPS Status

Weather

16.2.1 GPS Status Page

Nearest

The GPS Status Page provides a visual reference of GPS receiver functions, including current satellite coverage, GPS receiver status, position accuracy, and displays your present position (in latitude and longitude) and altitude. The GPS Status Page also displays the current UTC time at the top right of the page.

Services/
Music

Utilities

System

Messages

Symbols



1. While viewing the System page, touch **GPS Status**.

Appendix

Index

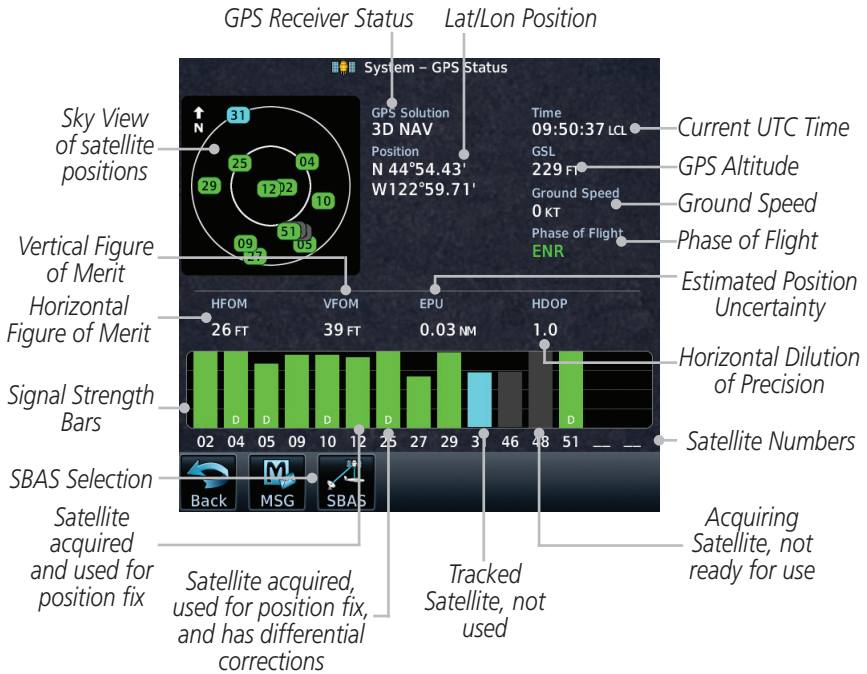

Figure 16-5 GPS Status Page

2. If desired, touch the **SBAS** key to select an SBAS provider. The SBAS list is based on the Aviation database.
3. Touch the key for the desired SBAS provider.



Figure 16-6 SBAS Provider List

4. Touch the **Back** key to return to the System Status page.



As the GPS receiver locks onto satellites, a signal strength bar appears for each satellite in view, with the appropriate satellite number (01-32, SBAS satellites will have higher numbers) underneath each bar. The progress of satellite acquisition is shown in the following stages:

Graph Symbol	Description
No signal strength bars	The receiver is looking for the satellites indicated.
Gray signal strength bars	The receiver has found the satellite(s) and is collecting data.
Yellow signal strength bars	The receiver has collected the necessary data but the satellite is not being used in the position solution as it has been excluded.
Cross-hatch cyan signal strength bars	The receiver has found the satellite(s) but it has been excluded by the FDE program as a faulty satellite.
Solid cyan signal strength bars	The receiver has collected the necessary data, but is not using the satellite in the position solution.
Solid green signal strength bars	The receiver has collected the necessary data and the satellite is being used in the position solution.
D	The "D" character inside the bars indicates differential corrections (e.g., WAAS) are being used for that satellite.

Table 16-1 Signal Strength Bar Graph Description

The Time and other data may not be displayed until the unit has acquired enough satellites for a fix.

The sky view display at the left of the page shows the satellites currently in view as well as their respective positions. The outer circle of the sky view represents the horizon (with north at the top of the circle); the inner circle represents 45° above the horizon and the center point shows the position directly overhead.

Each satellite has a 30-second data transmission that must be collected (hollow signal strength bar) before the satellite may be used for navigation (solid signal strength bar). Once the GPS receiver has determined your position, the GTN unit indicates your position, altitude, track and ground speed. The GPS receiver status field also displays the following messages under the appropriate conditions:

GPS Signal Message	Description
Acquiring	The GPS receiver is acquiring satellites for navigation. In this mode, the receiver uses satellite orbital data (collected continuously from the satellites) and last known position to determine the satellites that should be in view.
3D Nav	The GPS receiver is in 3D navigation mode and computes altitude using satellite data.
3D Diff Nav	The GPS receiver is in 3D navigation mode and differential corrections are being used.
LOI	The "LOI" (Loss Of Integrity) annunciator (bottom left corner of the screen) indicates that satellite coverage is insufficient to pass built-in integrity monitoring tests.

Table 16-2 GPS Signal Messages

The GPS Status Page also indicates the accuracy of the position fix, using Horizontal Figure of Merit (HFOM), Vertical Figure of Merit (VFOM), and Estimated Position Uncertainty (EPU). HFOM and VFOM represent the 95% confidence levels in horizontal and vertical accuracy. The lowest numbers are the best accuracy and the highest numbers are worse. EPU is the horizontal position error estimated by the Fault Detection and Exclusion (FDE) algorithm, in feet or meters.

- Foreword
- Getting Started
- Audio & Xpdr Ctrl
- Com/Nav
- FPL
- Direct-To
- Proc
- Charts
- Wpt Info
- Map
- Traffic
- Terrain
- Weather
- Nearest
- Services/ Music
- Utilities
- System**
- Messages
- Symbols
- Appendix

Foreword

Getting Started

Audio & Xpdr Ctrl

Com/Nav

FPL

Direct-To

Proc

Charts

Wpt Info

Map

Traffic

Terrain

Weather

Nearest

Services/ Music

Utilities

System

Messages

Symbols

Appendix

Index



NOTE: *Operating outside of an SBAS service area with SBAS enabled may cause elevated EPU values to be displayed on the satellite status page. Regardless of the EPU value displayed, the LOI annunciation is the controlling indication for determining the integrity of the GPS navigation solution.*



NOTE: *The FDE Prediction program is used to predict FDE availability. This program must be used prior to all oceanic or remote area flights for all operators using the GTN as a primary means of navigation under FAR parts 91, 121, 125, and 135. The FDE program is part of the GTN trainer, available for download from the GTN product information page on Garmin's website, flyGarmin.com.*

If the GTN has not been operated for a period of six months or more, acquiring satellite data to establish almanac and satellite orbit information can take 5 to 10 minutes.

The Time and other data may not be displayed until the unit has acquired enough satellites for a fix.

16.2.2 Satellite-Based Augmentation System (SBAS)

SBAS is a system that supports wide area, or regional, augmentation through the use of additional satellite broadcast messages. WAAS, EGNOS, MSAS, and GAGAN are known SBAS providers.

At the time of printing, SBAS providers support the following areas:

- WAAS provides SBAS service for Alaska, Canada, the 48 contiguous states, and most of Central America.
- EGNOS provides SBAS service for most of Europe and parts of North Africa.
- MSAS provides SBAS service for Japan only.
- GAGAN provides SBAS service for India. Available with GPS software v5.2 and later.

1. While viewing the System page, touch **GPS Status**.
2. If desired, touch the **SBAS** key to select an SBAS provider. The SBAS list is based on the Aviation database.



3. Touch the key for the desired SBAS provider.



Figure 16-7 SBAS Selection Page



4. Touch the **Back** key to return to the System Status page.

16.2.3 Circle of Uncertainty

The Circle of Uncertainty depicts an area where the ownship location is guaranteed to be when the aircraft location cannot be accurately determined. The area of the Circle of Uncertainty becomes larger as GPS horizontal accuracy degrades and smaller as it improves. The Circle of Uncertainty is shown only when the aircraft is on the ground. The Circle of Uncertainty area is transparent so that features within it may still be seen.



Figure 16-8 Circle of Uncertainty

16.2.4 GPS Faults

The GTN communicates various fault conditions that can affect the accuracy of the GPS. These include loss of integrity, loss of navigation, and a loss of position.

Loss of Integrity

A loss of integrity is when the integrity of the GPS position does not meet the requirements for the current phase of flight. This only occurs before the final approach fix (if an approach is active).

The GTN indicates a loss of integrity by displaying the amber "LOI" annunciation at the bottom of the screen.

Loss of Navigation

A loss of navigation can be caused by any of the following conditions:

- Aircraft is after the final approach fix and GPS integrity does not meet the active approach requirements
- Insufficient number of satellites supporting aircraft position (i.e., more than 5 seconds pass without adequate satellites to compute a position)
- GPS sensor detects an excessive position error or failure that cannot be excluded within the time to alert
- On-board hardware failure

The GTN indicates a loss of navigation by invalidating the active course guidance, and issuing a system message describing the cause.

Loss of Position

If the GTN cannot determine a GPS position solution, the ownship icon disappears and the amber "No GPS Position" annunciation appears across the map pages. For information about managing limited navigation features, refer to section 1.10.

- Foreword
- Getting Started
- Audio & Xpdr Ctrl
- Com/Nav
- FPL
- Direct-To
- Proc
- Charts
- Wpt Info
- Map
- Traffic
- Terrain
- Weather
- Nearest
- Services/ Music
- Utilities
- System**
- Messages
- Symbols
- Appendix
- Index

16.3 External LRUs

The External LRU page displays the external equipment connected to the GTN and their connection status.



1. While viewing the System page, touch the **External LRUs** key.

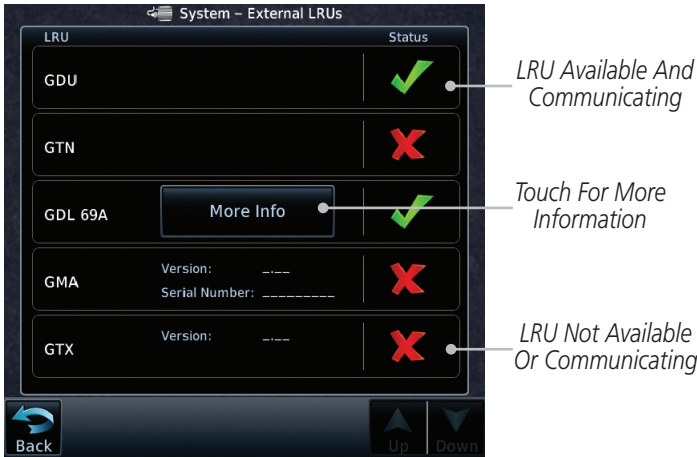

Figure 16-9 External LRU Page



2. When more information is available about the listed units, touch the **More Info** key to view the information.

16.3.1 GDL 69 (and GDL 69A) Status

The GDL 69 Status page displays the serial numbers for the Data Radio for the GDL 69/69A and the Audio Radio for the GDL 69A. Subscription status displays the level of service available for your particular subscription. The Weather Products section lists the products available for your particular subscription.



1. While viewing the External LRUs page, touch **More Info** for the GDL 69 LRU.



Figure 16-10 GDL 69/99A Status Page

2. Touch the **Menu** key to display the GDL 69 Status Menu.

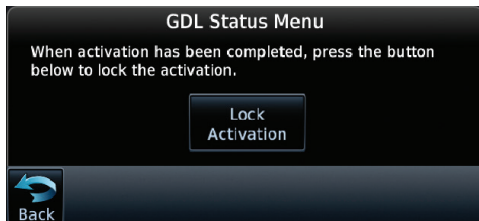

Figure 16-11 GDL Status Menu

3. Touch the **Lock Activation** key if this is for the initial subscription or a change in the subscription. Touch the **OK** key to continue the operation.

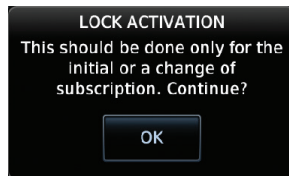
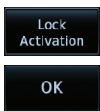

Figure 16-12 Lock Activation

4. Touch the **Back** key to return to the System page.



Foreword
Getting Started
Audio & Xpdr Ctrl
Com/Nav
FPL
Direct-To
Proc
Charts
Wpt Info
Map
Traffic
Terrain
Weather
Nearest
Services/ Music
Utilities
System
Messages
Symbols
Appendix

16.3.2 GDL 88 or GTX 345 Status

The GDL 88 or GTX 345 Status page displays information about the status of the GDL 88 or GTX 345.

Status	Description
On	Application is on/running. Required ownership input data is available and meets the performance criteria.
Available to Run	Application is configured. Required input data is available and meets the performance criteria. This state represents that the ASA Application is manually or automatically selected off.
Unavailable – Fault	Required Input data is not available due to a failure or the ASA Application process is failed.
Unavailable to Run	Required Input data is available but does not meet the performance criteria or is not available due to Non-Computed Data (NCD) conditions.

Table 16-3 Traffic Application Status

- More Info** 1. While viewing the External LRUs page, touch **More Info** for the GDL 88 or GTX 345 LRU.

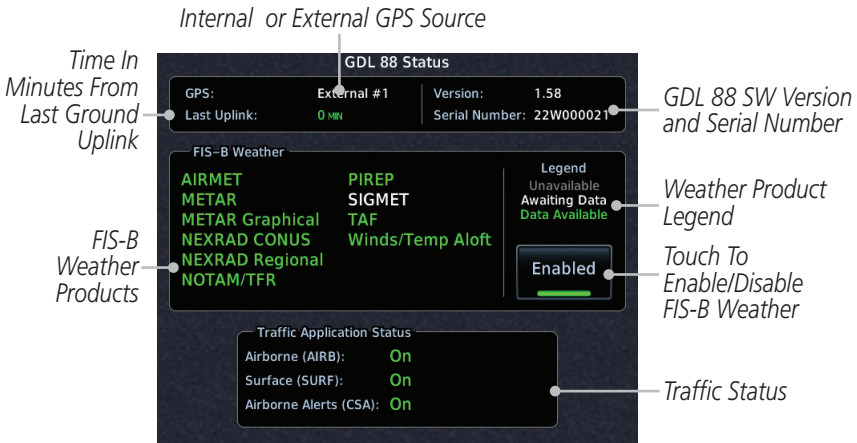

Figure 16-13 GDL 88 Status

- Enabled** 2. Touch the **Enabled** key to toggle whether FIS-B Weather is enabled/disabled for use.

16.3.3 GSR 56 Status

The GSR 56 Status page displays information about the status of the GSR 56.

More Info

1. While viewing the External LRUs page, touch **More Info** for the GSR 56 LRU.



Figure 16-14 GSR 56 Status

Connex Registration

2. Touch the **Connex Registration** key to display the Connex Registration display.

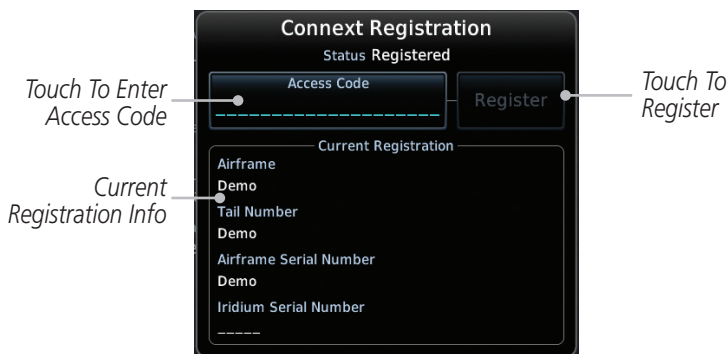

Figure 16-15 Connex Registration Page

16.4 Setup

The System Setup page allows you to:

- Select CDI scale and ILS CDI capture type
- Specify time format and local offset
- Access nearest airport search filtering options
- Access COM/NAV radio settings
- Select keyboard format
- Enable crossfilling to a second GTN or GNS unit

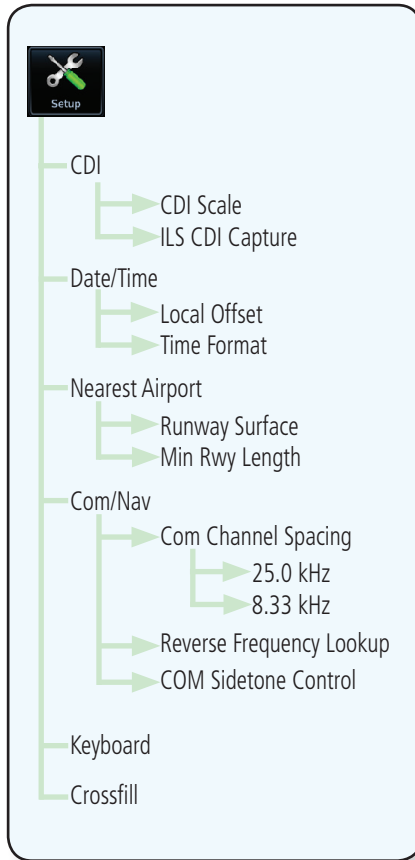

Figure 16-16 System Setup Functions



1. While viewing the System page, touch the **Setup** key.

Touch to Select
CDI Scale

Touch to Set
ILS CDI Capture

Touch to Set
Time Offset

Touch to Set
Time Format



Touch to Select
Nearest Airport
Criteria

Touch to Set Up
Com and Nav
Radios

Touch to Select
Keyboard Format

Touch to Enable
Crossfill With Dual
GTN Units

Figure 16-17 System Setup Page



2. After making the desired selections, touch the **Back** key to return to the Setup page.

16.4.1 CDI Scale Selection

The CDI source and ILS CDI Capture type may be selected manually or automatically. The selected CDI Scale will be reflected in the annunciation bar at the bottom of the display.

CDI Scale Selection allows you to define the scale for the course deviation indicator (both on the GTN unit's on-screen CDI and the external CDI). The scale values represent full scale deflection for the CDI to either side. The default setting is "Auto." At this setting, the CDI scale is set to 2.0 NM during the "en route" phase of flight. Within 31 NM (terminal area) of your destination airport, the CDI scale linearly ramps down to 1.0 NM over a distance of 1 NM. Likewise, when leaving your departure airport the CDI scale is set to 1.0 NM and gradually ramps up to 2 NM beyond 30 NM (from the departure airport). During GPS approach operations the CDI scale gradually transitions down to an angular CDI scale. At 2.0 NM before the final approach fix (FAF), CDI scaling is tightened from 1.0 NM to the angular full scale deflection (typically the angular full-scale deflection is 2.0°, but will be as defined for the approach).

If a lower CDI scale setting is selected (i.e., 1.0 or 0.3 NM), the higher scale settings are not selected during ANY phase of flight. For example, if 1.0 NM is selected, the GTN unit uses this for en route and terminal phases and ramps down further during an approach. Note that the Horizontal Alarm (HAL) protection limits listed below follow the selected CDI scale, unless corresponding flight phases call for lower HAL. For example, if the 1.0 NM CDI setting is selected, full-scale deflection during approach will still follow the approach CDI scale settings.

CDI Scale	Horizontal Alarm Limit
Auto (oceanic)	2.0 NM
±2.0 NM or Auto (en route)	2.0 NM
±1.0 NM or Auto (terminal)	1.0 NM
±0.3 NM or Auto (approach)	0.3 NM

Table 16-4 CDI Scale and Horizontal Alarm Limits

An “auto” ILS CDI selection allows the GTN unit to automatically switch the external CDI from the GPS receiver to the VLOC receiver, when intercepting the final approach course. Or, select “manual” to manually switch the external CDI connection, as needed (using the **CDI** key). If the unit is installed with a KAP140/KFC225 autopilot, automatic switching will not take place.

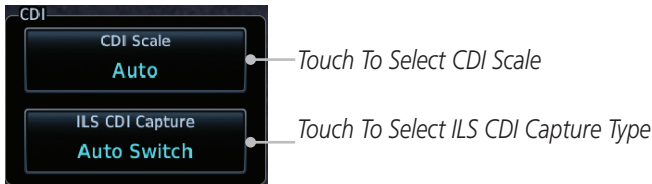

Figure 16-18 CDI Selection

1. While viewing the System Setup page, touch the **CDI Scale** key to allow automatic selection or to choose a CDI Scale manually.

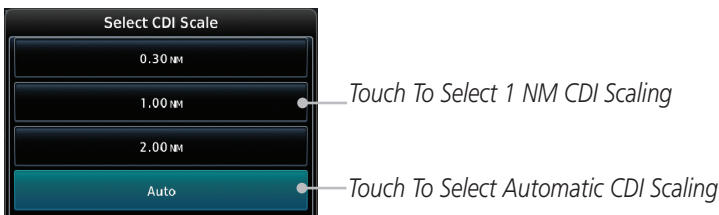

Figure 16-19 CDI Scale Selection

ILS CDI Capture
Auto

2. Touch the **ILS CDI Capture** key to select automatic or manual. This feature enables the unit to automatically switch from GPS to VLOC on an ILS approach. See *Procedures-ILS Approaches* for more detail on ILS approaches.



NOTE: The ILS CDI Capture key may be disabled in certain GTN installations.

16.4.2 Date/Time

The Date/Time setting provides selection of time format (local or UTC; 12- or 24-hour). UTC (also called “GMT” or “Zulu”) date and time are calculated directly from the GPS satellites’ signals and cannot be changed.

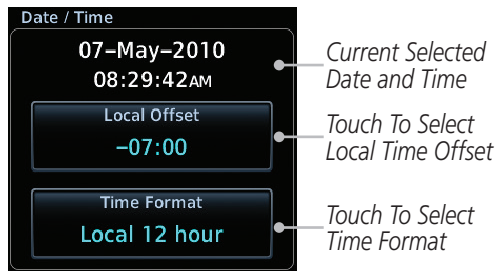

Figure 16-20 System Date and Time Setup

Local Offset
-07:00

1. While viewing the System Setup page, touch **Local Offset** to set the time offset for local time.

←
Enter

2. Use the keypad to select the desired local offset and then touch **Enter**.

Time Format
Local 12 hour

3. While viewing the System Setup page, touch the **Time Format** key to select local 12 hour, local 24 hour, or UTC time.

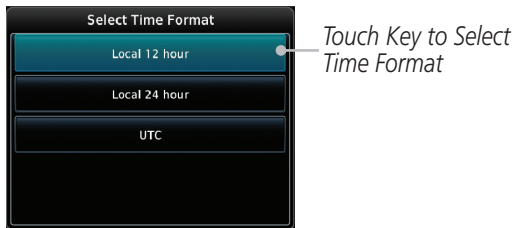

Figure 16-21 Select System Time Format

4. Touch the key for the desired time format.

16.4.3 Nearest Airport Criteria

Nearest Airport Criteria defines the surface type and minimum runway length used when determining the 25 nearest airports to display on the Nearest Airport Page. A minimum runway length and/or surface type may be entered to prevent the display of airports with small runways, or runways that do not have an appropriate surface. Deselecting **Include User Airports** excludes user-defined airports from the nearest airport search.

Default settings are “0 feet (or meters)” for runway length and “any” for runway surface type.



1. While viewing the System Setup page, touch the **Nearest Airport** key.



Touch To Select Runway Surface Type

Touch To Select Minimum Runway Length

Touch To Include User Airports

Figure 16-22 Select Nearest Airport Criteria



2. Touch **Runway Surface** to display the options. Select the desired surface type.



Touch to Select Any Runway Surface

Touch to Select Hard Runway Surfaces Only

Touch to Select Hard or Soft Runway Surfaces

Touch to Select Water Surfaces Only

Figure 16-23 Nearest Airport Runway Surface Type



3. Touch **Minimum Runway Length** to display the keypad for selecting the minimum runway length. Select the desired minimum runway length with the numeric keypad. A selection of “0” will allow any length.

Foreword
Getting Started
Audio & Xpdr Ctrl
Com/Nav
FPL
Direct-To
Proc
Charts
Wpt Info
Map
Traffic
Terrain
Weather
Nearest
Services/Music
Utilities
System
Messages
Symbols
Appendix
Index



Touch to Delete Values

Touch to Set Values

Figure 16-24 Nearest Airport Runway Length

4. After selecting the runway length, touch the **Enter** key to save the entered values, or touch the **Back** key to return to the System Setup page without saving a value.
5. Touch **Include User Airports** to include or exclude user created airports.

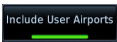

16.4.4 Com/Nav Setup

16.4.4.1 Com Channel Spacing

Com transceiver channel spacing may be selected between 8.33 kHz and 25.0 kHz.



While viewing the Setup COM/NAV page, touch **Channel Spacing** to toggle between 8.33 kHz and 25.0 kHz channel spacing.

16.4.4.2 Reverse Frequency Look-Up

The identifier and frequency type will be shown for the selected Com and Nav frequencies for the nearest stations that are in the database when the unit is receiving a valid position input. Station Identifiers with a “+” sign will have more stations associated with this frequency than just the type displayed.

Reverse Frequency
Lookup

While viewing the Setup COM/NAV page, touch the **Reverse Frequency Lookup** key to toggle the function.

Airport
Identifier and
Type Shown
For Freqs In
Database.

The “+” Sign
Indicates
More Stations
Associated
With This
Frequency



Identifier
and Type
Shown For
Freqs In
Database

Reverse
Frequency
Lookup
Selected

Figure 16-25 Reverse Frequency Lookup Selected

Foreword

Getting
Started

Audio &
Xpdr Ctrl

Com/Nav

FPL

Direct-To

Proc

Charts

Wpt Info

Map

Traffic

Terrain

Weather

Nearest

Services/
Music

Utilities

System

Messages

Symbols

Appendix

16.4.4.3 COM Sidetone Control



NOTE: This feature is available in software v6.50 and later. It requires enablement by the installer.

COM sidetone is audio spoken into the COM microphone that is played back in real-time over the headset. An offset setting determines sidetone volume for the COM during radio transmission. Controls allow adjustment of the amount that the COM sidetone volume level is offset from the COM receiver volume or the configured sidetone volume.

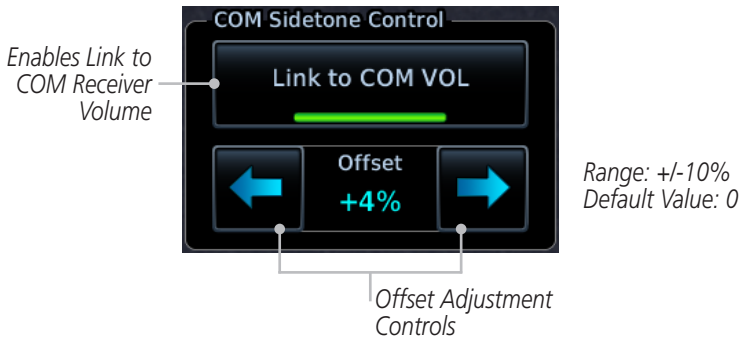
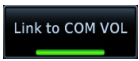

Figure 16-26 COM Sidetone Controls

To adjust the offset from the COM receiver volume:



1. While viewing the System Setup page, touch the **Com/Nav** key.



2. Select **Link to COM VOL**.

3. Adjust offset as necessary.

To adjust the offset from the configured sidetone volume, deselect **Link to COM VOL** and then adjust the offset as necessary.

16.4.5 Keyboard Format



NOTE: The QWERTY keyboard format is available in software v6.50 and later.

The GTN 7XX employs two keypad types to serve specific settings and functions.



Tapping **Keyboard** changes the format between ABC and QWERTY.



Figure 16-27 Keyboard Formats

Keyboard	Description
ABC	Alphabetical layout
QWERTY	U.S. standard keyboard layout

Table 16-5 Keyboard Formats

16.4.6 Crossfill

Dual units may be interfaced to crossfill information between the two units. This option will not be available unless dual units are configured.

When Crossfill is turned on with one GTN, it is automatically turned on in the other GTN. Some items are always crossfilled regardless of the crossfill setting; others are dependent on the crossfill setting.

The GTN can be can also be interfaced with the GNS 400W/500W units. The GTN can automatically send the Active Flight Plan and active Direct-To course to the GNS unit. The GTN User Waypoints can be manually sent to the GNS unit. The GNS unit can manually send its User Waypoints to the GTN unit.

Waypoint names longer than six characters, or duplicates, sent from the GTN unit to the GNS unit will replace some characters with a "+" sign, while leaving significant characters to aid in identification (such as, USR003 becomes US+003).



NOTE: Upon crossfill being activated, the GTNs may take up to 10 seconds to crossfill the flight plans. The pilot must verify the flight plan in each unit prior to use. The GTN and GNS units must have databases with the same cycle.



NOTE: When GPS navigation is lost in either unit, crossfilling may not be available until GPS is restored in both units. Crossfilling will resume once the flightplan is changed on one of the units or crossfill is re-enabled.



NOTE: If two GTN 7XX units are crossfilled, then the same type (ChartView or FlightCharts) and version (cycle number and effective dates) for the chart database must be installed on both units in order for the correct chart to be overlaid on the main map page.

16.4.6.1 GTN-to-GTN Crossfilling

This data is always crossfilled:

- User waypoints
- Flight plan catalog
- Alerts (traffic pop-up acknowledgement, missed approach waypoint pop-up acknowledgement, altitude leg pop-up acknowledgement)
- External sensors (transponder status and commands, synchro heading)
- System setup:
 - User-defined NAV frequencies to store favorites
 - Date/Time convention
 - Nearest airport criteria
 - Units (Nav angle, Fuel, and Temperature)
 - User-defined COM frequencies to store favorites
 - CDI Scale setting
 - ILS CDI Capture setting

This data is crossfilled only if crossfill is turned on by the pilot:

- Active navigation (flight plan)



NOTE: *There is an installer option to turn on a system message that will be provided anytime crossfill is turned off to alert the pilot that flight plans are not being crossfilled.*

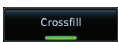

1. While viewing the System Setup page, touch the **Crossfill** key to toggle between Enabled and Disabled Crossfill.

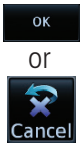

2. When Crossfill is about to be enabled, you will be prompted to note that data will be overwritten in the other unit. Touch **OK** to enable Crossfill or touch **Cancel** to return to the System Setup page without enabling Crossfill.



Touch OK to Enable Crossfill With Dual Units

Figure 16-28 Confirming Crossfill Selection

16.4.6.2 GTN-GNS Crossfilling

- GTN to GNS – Active flight plans, active direct-to, User waypoints
- GNS to GTN – User waypoints

GNS Crossfill Settings

1. While viewing the System Setup page, touch the **GNS Crossfill Settings** key to reach the GNS Crossfill settings.

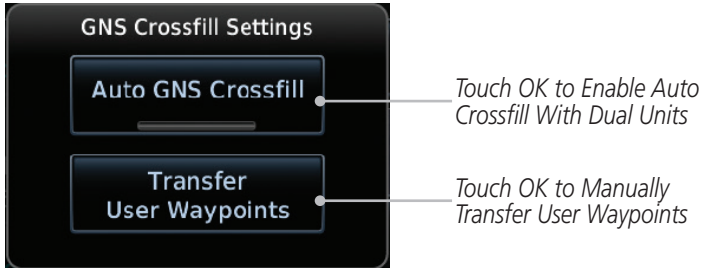

Figure 16-29 GTN-GNS Crossfill Selection



NOTE: When the active flight plan on the GTN contains legs or features that are not supported by the GNS, those legs will not be crossfilled and will not be present in the active flight plan on the GNS.

Auto GNS Crossfill

2. Touch **Auto GNS Crossfill** to enable Crossfill and send the Active Flight Plans and the active Direct-To course to the GNS unit.

Transfer User Waypoints

3. Touch the Transfer User Waypoints key to transfer the User Waypoints from the GTN unit to the connected GNS unit.

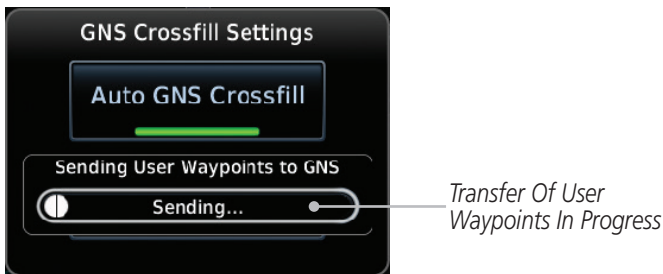

Figure 16-30 GTN-GNS Crossfill

16.4.6.3 GTN-G3X Touch Crossfilling



NOTE: Requires pilot activation on both the GTN and the G3X Touch. This feature is available in software v6.60 and later.

When this function is enabled by the pilot, active flight plan navigation is crossfilled with the G3X Touch. It is recommended that all flight plan edits be made using the G3X Touch when this function is active.

External FPL XFILL

1. While viewing the System Setup page, touch **External FPL XFILL** to toggle between Enabled and Disabled Crossfill with the G3X Touch.
2. Ensure that the crossfilling function on G3X Touch is active.

Foreword

Getting Started

Audio & Xpdr Ctrl

Com/Nav

FPL

Direct-To

Proc

Charts

Wpt Info

Map

Traffic

Terrain

Weather

Nearest

Services/
Music

Utilities

System

Messages

Symbols

Appendix

16.5 Alerts Settings

The Alerts Setup page controls two functions: Arrival Alerts and Airspace Alerts. Arrival Alerts, when active, will generate a message when the aircraft is within the selected proximity of the destination. Airspace Alerts generate a message and filtering of the Nearest Airspace list. The altitude component of Airspace Alerts are dependent on both aircraft and airspace altitude and the values set for the Altitude Buffer.

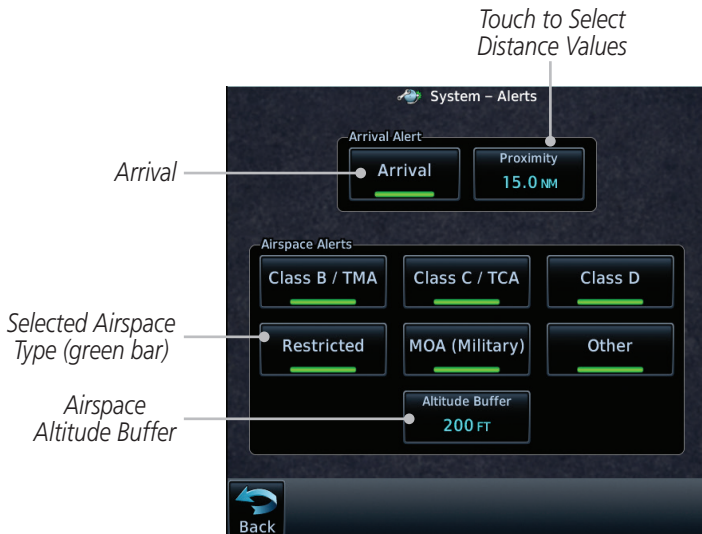
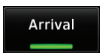

Figure 16-31 Alerts Setup Page

1. While viewing the System page, touch the **Alerts** key.
2. Touch the **Arrival** key to toggle activation. A green bar will appear when it is active.



Foreword
Getting Started
Audio & Xpdr Ctrl
Com/Nav
FPL
Direct-To
Proc
Charts
Wpt Info
Map
Traffic
Terrain
Weather
Nearest
Services/Music
Utilities
System
Messages
Symbols
Appendix
Index



3. Touch the **Proximity** key to set the Proximity distance values. A numeric keypad will appear. Select the desired values and then touch **Enter**.

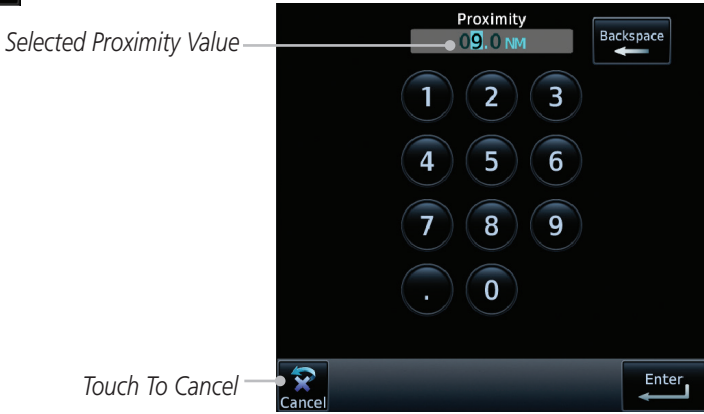
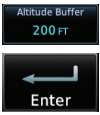

Figure 16-32 Airspace Alert Proximity Selection



4. Touch the **Altitude Buffer** key to set the buffer altitude value. A numeric keypad will appear. Select the desired value and then touch **Enter**.

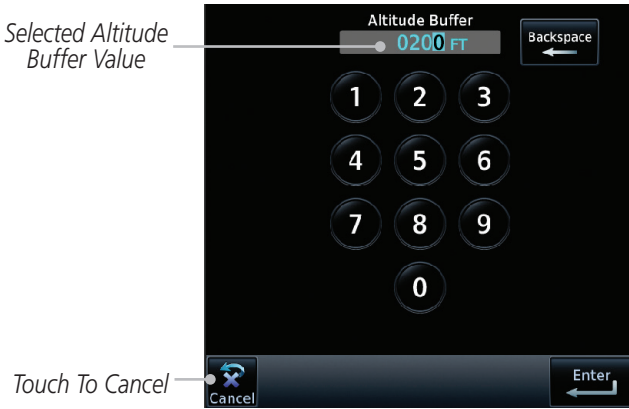

Figure 16-33 Airspace Alert Altitude Buffer Selection

5. Touch the Airspace type keys to toggle activation. A green bar will appear when it is active.



NOTE: The Airspace Alert setting does not alter the depiction of airspace, or change the Smart Airspace setting for the main map page.



NOTE: Airspace alerts for Prohibited airspace cannot be disabled.

16.6 User Fields

The User Fields selection allows you to configure the data field type shown at the top of the display in the center fields when they are not occupied by controls for an audio panel or transponder. The data shown in each field may be selected from a list after touching the desired field.



NOTE: Data Field Types that use the term "Destination" refer to the final destination in the flight plan.



NOTE: ETE to Destination is not available when a procedure is loaded and there are waypoints in the Enroute section of the flight plan.



1. While viewing the System page, touch the **User Fields** key, then touch an available field in the top of the display.

Terrain Page Assigned To Field
Touch To Select Field
Touch To Select Category (Data, Function, or Page). Data selected in this case.



Figure 16-34 User Fields Selection

2. Touch the **Data**, **Function**, or **Page** tab to display a list of available selections. A list of information types will be displayed.
3. Touch the **Up** or **Down** keys or touch the display and drag your finger to scroll through the list. Touch the desired item to select it or touch the **Back** key to cancel selection.



Field Type List. Touch To Select Data Field



Slider Indicates More Selections Available. Press Finger and Slide To View More Selections.

Selected Field Type

Figure 16-35 Map Data Field Type Selections

The options available are shown in the following tables. Selections available vary depending on installed equipment.

Data Field Type	
ACTV WPT - Active Waypoint	MSA - Minimum Safe Altitude
B/D APT - BRG/DIS from Dest APT ¹	OAT (static) - Static Air Temperature
BRG - Bearing to Current Waypoint	OAT (total) - Total Air Temperature
DIS - Distance to Current Waypoint	RAD ALT - Radar Altimeter
DIS to Dest - Distance to Destination ²	Time - Current Time
DTK - Desired Track	Time to TOD - Time to Top of Descent
ESA - Enroute Safe Altitude	TKE - Track Angle Error
ETA - Estimated Time of Arrival	TRK - Track
ETA at Dest - ETA at Destination	Trip Timer - Timer Display
ETE - Estimated Time Enroute	VOR/LOC - Tuned VOR/LOC Info
ETE to Dest - ETE to Destination	VSR - Vertical Speed Required
Fuel Flow - Total Fuel Flow	Wind - Wind Speed and Direction
GS - GPS Ground Speed	XTK - Cross Track Error
GSL - GPS Altitude	OFF - Do Not Display Data Field
Generic Timer - Timer Display	

Table 16-6 Data User Field Selections

Note 1: B/D APT is the straight line distance.

Note 2: Dist to DEST is the distance along the flight plan.

Function Field Type		
Foreword	CDI - Course Deviation Indicator	MIC PA Mode - Passenger Address Toggle
Getting Started	Flap Override - Flap Override ¹	Playback - Play Last Recording
Audio & Xpdr Ctrl	GPWS Inhibit - GPWS Inhibit ¹	TAWS Inhibit - TAWS Inhibit
Com/Nav	G/S Inhibit - G/S Inhibit ¹	Gen Timer - Generic Timer Control
FPL	HTAWS RP Mode - HTAWS RP Mode ²	WX RDR Controls - Weather Radar Controls
Direct-To	OBS/Suspend/Unsuspend Button	OFF - Do Not Display Data Field
	On Scene - "On Scene" Mode Toggle	

Table 16-7 Function User Field Selections

Note 1: With TAWS-A enabled.

Note 2: With HTAWS enabled.

Map Page Field Type		
Map	Blackout Mode	Checklist - Checklist Page
Traffic	Charts - Charts Page	Fuel PLAN - Fuel Planning Page
Terrain	Flight Plan - Flight Plan Page	SCHED MSG - Scheduled Messages
Weather	Map - Map Page	Trip PLAN - Trip Planning Page
Nearest	Nearest - Nearest Page	VCALC - VCALC Page
Services/Music	NEAR APT - Nearest Airport Page	User FREQ - User Frequencies
Utilities	PROC - Procedures Page	WPT INFO - Waypoint Information
System	Approach - Approach Page	Weather - Weather Page
Messages	Arrival - Arrival Page	CNXT WX - Connex WX Page
	Departure - Departure Page	FIS-B WX - FIS-B Weather Page
	Backlight - Backlight Page	Stormscope - Stormscope Page
	Services - Services Page	WX Radar - Weather Radar Page
	Traffic - Traffic Page	SiriusXM WX - Sirius XM WX Page
	Terrain - Terrain Page	OFF - Do Not Display Page Field
	Utilities - Utilities Page	

Table 16-8 Page User Field Selections

16.7 Units Settings

The Units Setup page allows you to select the conventions for the various units that are displayed.

Units Type	Units Values
Altitude/Vertical Speed	Feet(FT/FPM), Meters (M/MPS)
Distance/Speed	Nautical Miles (NM/KT), Kilometers (KM/KPH), Statue Miles (SM/MPH)
Fuel ¹	Gallons (GAL), Imperial Gallons (IG), Kilograms (KG), Liters (LT), or Pounds (LB)
Nav Angle ¹	Magnetic (°), True (°T), User (°u)
Magnetic Variation	Enter numeric value, E or W
Position Format	LAT/LON DD.D°, LAT/LON DD° MM.M', LAT/TON DD° MM'SS", MGRS, UTM, Swiss Grid, Irish Grid, British National Grid
Pressure	Inches of Mercury (IN), Hectopascals (HPA), Millibars (MB)
Temperature ¹	Celsius (°C) or Fahrenheit (°F)

Table 16-9 System Units Setup

Note 1: Only these unit types will be crossfilled in dual GTN installations.

16.7.1 Setup Units

Use these settings to set the units for values displayed in the unit operation.

1. While viewing the System page, touch the **Units** key.



Touch To Set
Units

Figure 16-36 System Units Page

- Touch the key for the desired units. A window with a list of unit values will appear. Touch the desired value on the list.

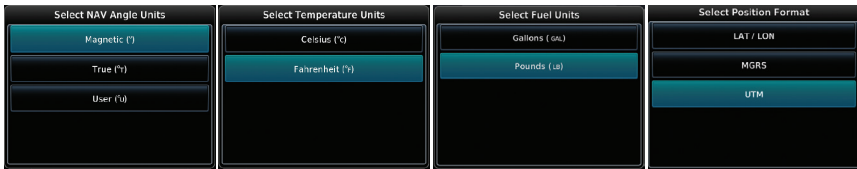

Figure 16-37 Setup Units Selection Windows

- After making the desired selections, touch the **Back** key to return to the Setup page.



16.7.2 Setting a User-Configured (Manual) Nav Angle

There are three variation (heading) options: Magnetic, True, and User. If “Magnetic” is selected, all track, course and heading information is corrected to the magnetic variation computed by the GPS receiver. The “True” setting references all information to true north. The “User” selection allows the pilot to enter values between 0° and 179° E or W. When configured by the installer, there may also be a fourth option: External. If “External” is selected, the GTN Nav Angle will be synchronized with the on-side MFD.



NOTE: When changing the Nav angle, the DTK on the Flight Plan page for an approach does not change until that approach is reloaded.

- While viewing the System page, touch **Units** key.
- Touch the **Nav Angle** key and then the **User** key.

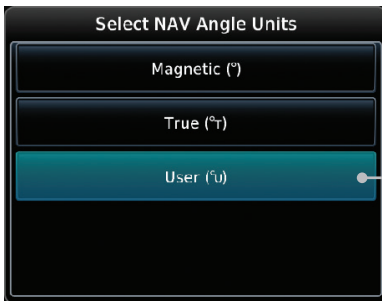

Figure 16-38 Nav Angle Selections

- After User is selected, touch the **Magnetic Variation** key to set the value.

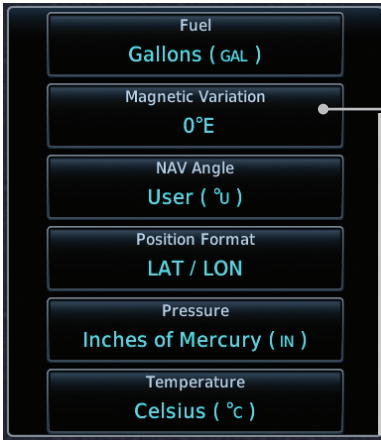

Figure 16-39 Magnetic Variation is Available for Editing

- Touch the keys on the numeric keypad to set the Magnetic Variation and then touch **Enter**.

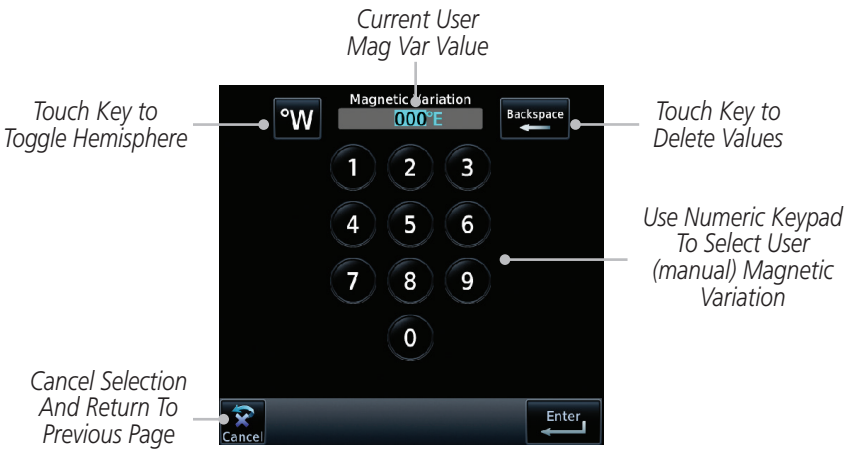

Figure 16-40 Numeric Keypad for Setting Manual Magnetic Variation

- The User Nav Angle value will be used for all angular values. Remember to change the value when traveling to an area requiring another value.

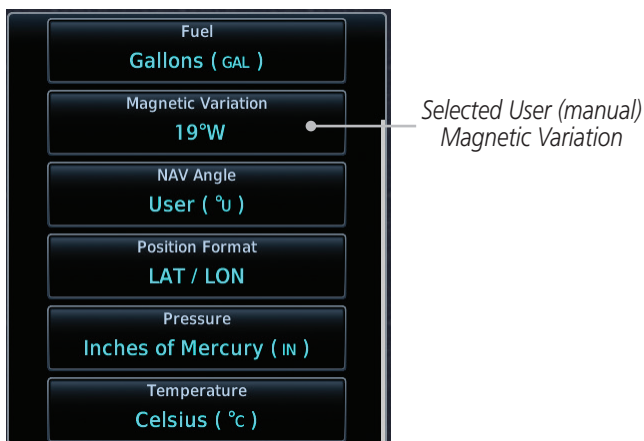

Figure 16-41 User (Manual) Magnetic Variation

16.7.3 Position Format Selection

There are multiple position formats available.

LAT/LON DD.D° **	British National Grid **	MGRS *
LAT/LON DD°MM.M'	Irish National Grid **	UTM *
LAT/LON DD°MM'SS" **	Swiss National Grid **	

* Software v4.10 and later.

** Software v6.50 and later.

The selected format is used in all locations where position information is available.

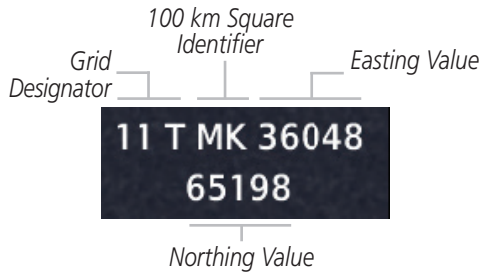

Figure 16-42 MGRS Position Format Detail

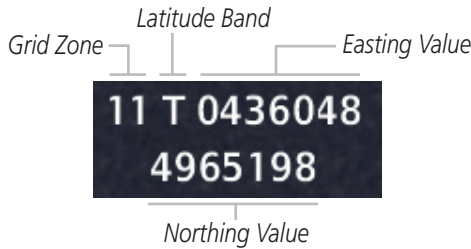

Figure 16-43 UTM Position Format Detail

In the case of regional position formats (e.g., Swiss National Grid), the GTN defaults to displaying LAT/LON for any positions outside of the grid region.



Figure 16-44 British National Grid Position Format Detail

Foreword
Getting Started
Audio & Xpdr Ctrl
Com/Nav
FPL
Direct-To
Proc
Charts
Wpt Info
Map
Traffic
Terrain
Weather
Nearest
Services/ Music
Utilities
System
Messages
Symbols
Appendix

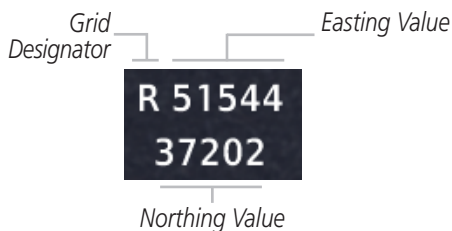

Figure 16-45 Irish National Grid Position Format Detail

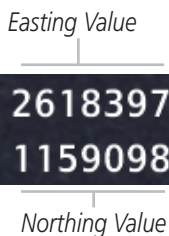

Figure 16-46 Swiss National Grid Position Format Detail



1. While viewing the System page, touch **Units** key.
2. Touch the **Position Format** key.

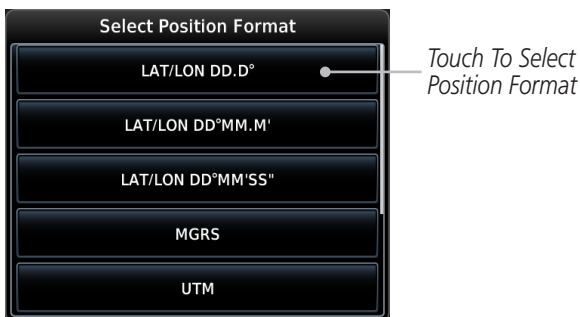

Figure 16-47 Position Format Selection

3. Touch the desired Position format.

16.8 Audio

The Audio Settings allows the adjustment of the volume the click sound when controls are touched.



1. While viewing the System page, touch **Audio** key.

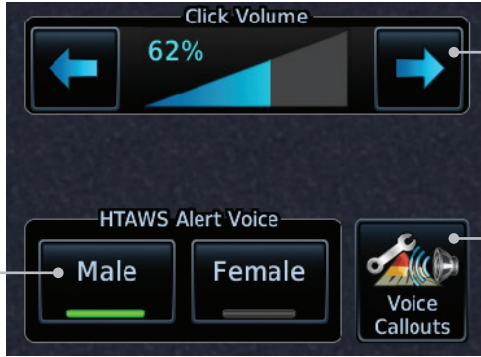

Touch The Arrow Keys To Adjust Click Volume

Touch To Select Voice (TAWS Only)

Touch To Select Voice Call Outs (Optional)

Figure 16-48 System Audio Selection



2. Touch the Arrow keys to adjust the Key Click Volume.



3. Touch the **Male** or **Female** key to select the audio voice type.



4. When HTAWS is installed, a Voice Call Outs option may be available. Touch the **Voice Callouts** key to select the Max Voice Call Out value.



NOTE: VCOs are available down to 100 feet above terrain when HTAWS is installed and use GSL above terrain to generate callouts (no radar altimeter required). If a radar altimeter is interfaced to the GTN, alerts are available down to 50 feet and the height above terrain from the radar altimeter is used to generate the callouts.

Foreword
Getting Started
Audio & Xpdr Ctrl
Com/Nav
FPL
Direct-To
Proc
Charts
Wpt Info
Map
Traffic
Terrain
Weather
Nearest
Services/ Music
Utilities
System
Messages
Symbols
Appendix
Index

MAX Voice Callout
None

5. Touch the **MAX Voice Callout** key to select the value.



Touch To Select Max Voice Callout

Touch To Select Voice Call Out Value

Figure 16-49 Select Voice Call Out Value

6. Touch **Back** when complete.



16.9 Backlight Settings

The backlighting of the display and bezel keys can be adjusted automatically or manually. The default setting (automatic backlighting adjustment) uses photocell technology to automatically adjust for ambient lighting conditions. Photocell calibration curves are pre-configured to optimize display appearance through a broad range of cockpit lighting conditions. A manual offset creates a deviation from the normal curve. Manual adjustments may be made from +100% to -10%. The negative adjustment is limited to prevent the backlight from being accidentally decreasing the backlight to the point where the display of information could not be seen.

The backlight offset function is not available when a dimmer input is active. The GTN is capable of accepting lighting inputs from the built-in photocell, aircraft dimmer bus, or both. If the lighting is not satisfactory, contact the installer to adjust the curves.

Manual backlighting adjustment can be accomplished using the existing instrument panel dimmer bus or the following procedures.



1. While viewing the System page, touch the **Backlight** key.



2. Touch the **Arrow** keys to adjust the Backlight level.

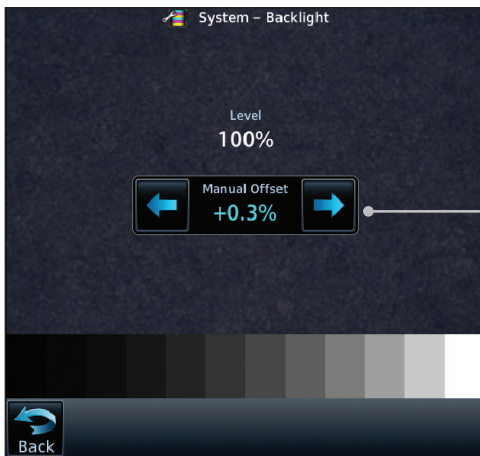

Touch The Arrow Keys For Manual Offset

Figure 16-50 Backlight Level Selection



3. After making the desired selections, touch the **Back** key to return to the System page.

16.10 Connex Setup - GSR 56

This page provides information about the GSR 56 and the Connex Registration page. See section 16.3.3 for more details.

1. While viewing the System page, touch **Connex Setup** to access the GSR 56 LRU Status page.
2. Touch **Connex Registration** to set up the Connex account. Follow the information provided in section 16.3.3.

16.11 Connex Setup - Flight Stream 210 and 510

NOTE: Refer to the Flight Stream product page on the Garmin website for portable device compatibility.

The GTN interfaces with the Flight Stream 210 Bluetooth transceiver and Flight Stream 510 wireless datacard. Using a Flight Stream and the GTN, flight plans are sent and received over Bluetooth. In addition, GPS position is provided from the GTN and attitude is forwarded from a connected GDU. The GTN can also configure the Flight Stream's Bluetooth.

The Flight Stream 510 also includes a Wi-Fi transceiver for updating databases. For more information on updating databases with Flight Stream 510, refer to section 19.2. The GTN can configure the Flight Stream 510's Wi-Fi. When setting up Wi-Fi, use a password that contains letters in mixed case and numbers.



Touch To Set
The Bluetooth
Name

Touch to Control
Flight Stream
Features

Touch to Set
Wi-Fi SSID (Flight
Stream 510 only)

Touch to Set
Wi-Fi Password
(Flight Stream
510 only)

Figure 16-51 Connex Setup for Flight Stream 510



NOTE: Turning Flight Plan imports off will remove the ability of the GTN to receive flight plans from the Flight Stream. This could be used if there are repeated erroneous attempts by a portable device application to send flight plans to the GTN.

16.11.1 Operation

Data output from the GTN and Flight Stream occurs automatically and requires no pilot action (such as, flight plan, GPS position, and attitude). Additionally, ADS-B traffic and weather can be output from the Flight Stream when connected to a GDL 88 or GTX 345 and XM WX and SiriusXM satellite radio information can output when connected a GDL 69. The Flight Stream 210 and 510 also support sending and receiving GSR 56 SMS messages and controlling the GSR 56 Iridium phone when used with a compatible portable application.

From the Connex Setup page, the pilot can enable or disable Flight Stream features (flight plan importing, phone/SMS, and database transfers), setup Flight Stream Bluetooth and Wi-Fi, and manage paired Bluetooth devices.

On the GTN's Paired Devices page, the device status indicates if the portable device is connected and communicating with the Flight Stream. The “Auto-Reconnect” setting determines if the Flight Stream will automatically connect to up to four devices when in range. When this setting is disabled, the pilot must initiate the connection from the device. For devices that always reconnect automatically, this setting will not be shown. Removing a device from this page by pressing “Remove” will require the device to be paired again before transferring data.



NOTE: If the pairing is removed from either device (portable device or GTN) it must be removed on the other device before a new pairing to that same device is established again. Essentially, pairing must be removed on both devices before repairing.

Foreword

Getting Started

Audio & Xpdr Ctrl

Com/Nav

FPL

Direct-To

Proc

Charts

Wpt Info

Map

Traffic

Terrain

Weather

Nearest

Services/
Music

Utilities

System

Messages

Symbols

Appendix

Foreword
Getting Started
Audio & Xpdr Ctrl
Com/Nav
FPL
Direct-To
Proc
Charts
Wpt Info
Map
Traffic
Terrain
Weather
Nearest
Services/ Music
Utilities
System
Messages
Symbols
Appendix
Index

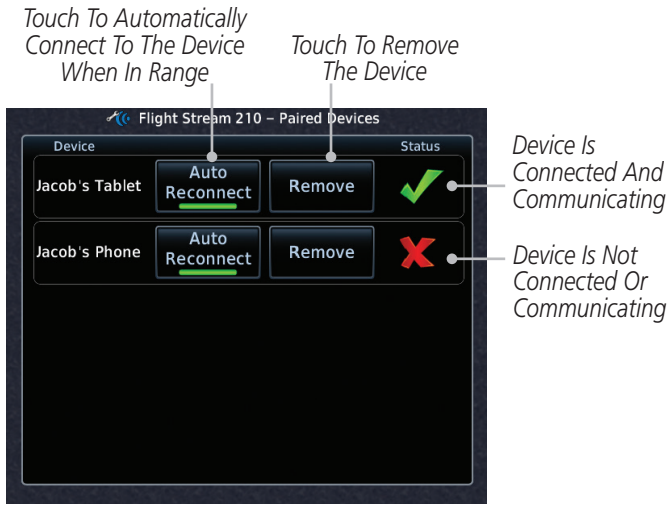

Figure 16-52 Managing Paired Devices

16.11.2 Pairing a Device

New devices can only be paired with the Flight Stream when it is in “Pairing Mode.” The Flight Stream will be in pairing mode when the GTN is navigated to the Connex Setup page and/or the Manage Paired Devices page. The pairing must be initiated by the portable device. Pop-ups display on both the portable device and GTN to confirm the pairing. Verify the passkey displayed on the GTN matches that on the portable device.

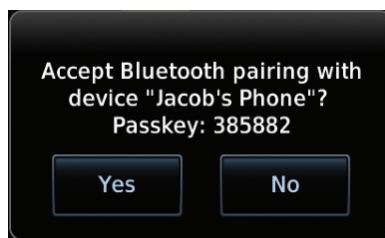

Figure 16-53 Confirm Pairing With A New Device

Selecting “Manage Paired Devices” opens a page that lists all of devices paired to the Flight Stream.

16.12 Connex Setup – Other Bluetooth Devices



NOTE: This feature is available in software v6.00 or later.

The GTN can also configure the Bluetooth transceiver in other units, such as the GMA 35c and GTX 345.

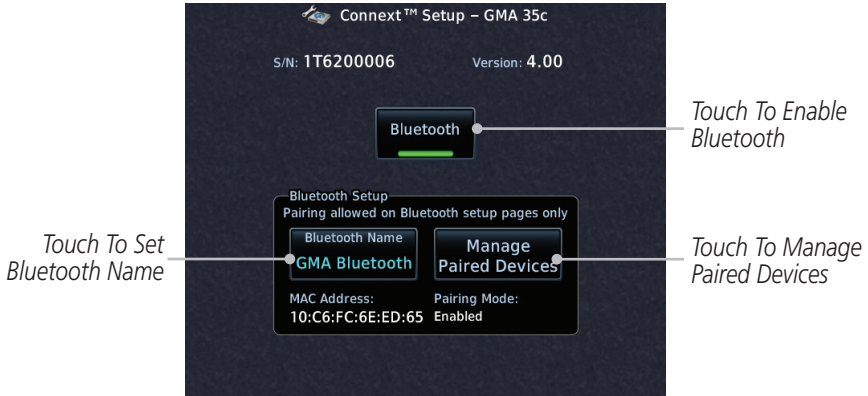

Figure 16-54 Connex Setup for GMA 35c

From the Connex Setup page, the pilot can enable/disable Bluetooth, change the Bluetooth name, and manage paired devices. On the Paired Devices page, the device status indicates if the portable device is paired and connected. To connect a different device when the maximum number are already connected, the existing connection must be ended by removing the portable device pairing or by disconnecting or disabling Bluetooth on the portable device. Removing a device from this page by pressing “Remove” will require the device to be paired again before reconnecting.



NOTE: Only one portable device can be connected to the GMA 35c at a time.



NOTE: If the pairing is removed from either device (portable device or installed avionics) it must be removed on the other device before a new pairing to that same device is established again. Essentially, pairing must be removed on both devices before re-pairing.

New devices can only be paired while the unit is in “Pairing Mode.” Pairing mode is active while on the Connex Setup page or the Manage Paired Devices page. The pairing must be initiated by the portable device. A pop-up will be displayed on the portable device to confirm the pairing.

16.13 Voice Command



NOTE: This feature is available in software v6.00 and later.

The Voice Command page allows controlling the voice command function and viewing the voice command status and recent commands. Voice Commands are only available when connected to a compatible Garmin audio panel and when enabled by the installer.

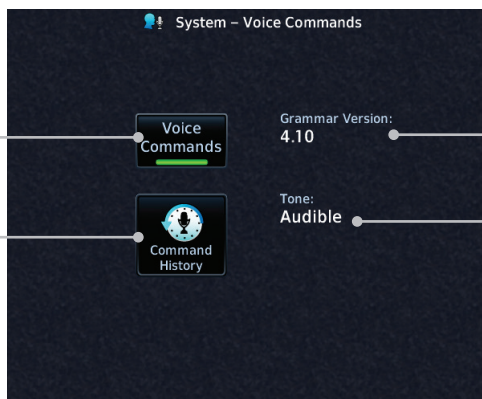

Figure 16-55 Voice Command Setup

1. While viewing the System page, touch the **Voice Commands** key.
2. Touch the **Voice Commands** key to toggle activation. A green bar will appear when Voice commands are active.
3. Touch the **Command History** key to open a list of recently spoken commands.

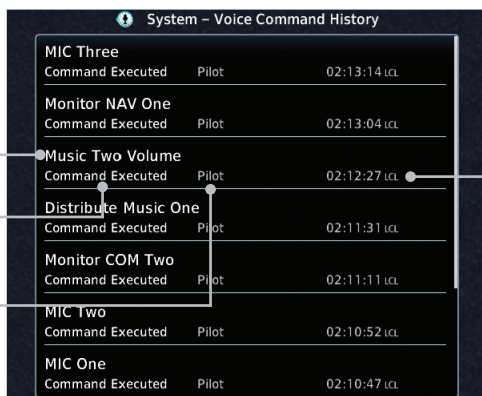

Figure 16-56 Voice Command History

17 MESSAGES

When a Message has been issued by the unit, the Message (**MSG**) key/annunciator in the lower left of the display will blink. Touch the **MSG** key to view the messages. After viewing the messages, touch the **Back** key to return to the previously viewed page. The Messages provide an aid to troubleshooting system operation.

System messages are not crossfilled between GTN units. Each GTN will display messages based on data received by that unit. This may result in duplication of messages between units, however the pilot should view messages on both GTN units when more than one is installed to ensure all messages are received.

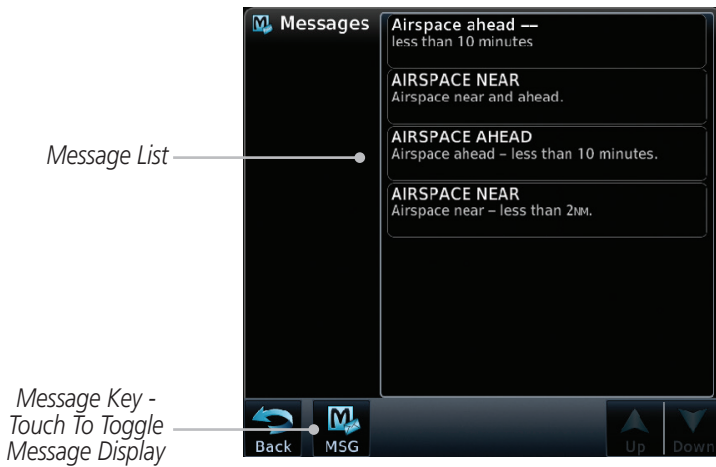

Figure 17-1 Message Display

Foreword

Getting Started

Audio & Xpdr Ctrl

Com/Nav

FPL

Direct-To

Proc

Charts

Wpt Info

Map

Traffic

Terrain

Weather

Nearest

Services/ Music

Utilities

System

Messages

Symbols

Appendix

Message	Description	Action
ABORT APPROACH - GPS approach no longer available.	This message is triggered outside the MAP if the GTN system can no longer provide approach level of service. Vertical guidance will be removed from the external CDI/HSI display.	Initiate a climb to the MSA or other published safe altitude, abort the approach, and execute a non-GPS based approach.
AIRSPACE ALERT - Airspace entry in less than 10 minutes.	The aircraft is predicted to enter an airspace type, within 10 minutes, for which alerts are configured.	No action is necessary; message is informational only.
AIRSPACE ALERT - Airspace within 2 nm and entry in less than 10 minutes.	The aircraft is within 2 nm and predicted to enter an airspace type, within 10 minutes, for which alerts are configured.	No action is necessary; message is informational only.
AIRSPACE ALERT - Inside airspace.	The aircraft inside an airspace type for which alerts are configured.	No action is necessary; message is informational only.
AIRSPACE ALERT - Within 2 nm of airspace.	The aircraft is within 2nm of an airspace type for which alerts are configured.	No action is necessary; message is informational only.
APPROACH DOWNGRADE - Approach downgraded. Use LNAV minima.	Approach has been downgraded from LPV or LNAV/VNAV, to an LNAV approach. Vertical guidance will be removed from the external CDI/HSI display.	Continue to fly the approach using published LNAV minimums.

Message	Description	Action
APPROACH NOT ACTIVE - Do not continue GPS approach.	GPS approach could not transition to active (e.g., the GTN is on an approach and did not have the required HPL/VPL to get into at least LNAV, so is still in TERM).	Abort the approach, and execute a non-GPS based approach.
APR GUIDANCE AVAILABLE - Press "Enable APR Output" before selecting APR on autopilot.	The GTN is configured for KAP140/KFC225 autopilot, and approach guidance is now available.	Press the "Enable APR Output" key on the GTN, this will cause the autopilot to go into ROL mode. Engage the autopilot into approach mode. See section 6.15 for additional information.
AUDIO PANEL - Audio panel is inoperative or connection to GTN is lost.	The GTN is configured for Garmin audio panel control (GMA 35) and the GTN cannot communicate with the GMA 35. No control of the GMA 35 will be possible.	Remove power from the GMA 35 audio panel by pulling the circuit breaker labeled "Audio." The pilot will be able to communicate with the Com 2 radio. Contact dealer for service.
AUDIO PANEL - Audio panel needs service.	The GMA 35 is reporting to the GTN that it needs service. The audio panel may continue to function.	Contact dealer for service.
CDI/HSI FLAG - Main lateral/vertical flag on CDI/HSI is inoperative.	The Main Lateral Superflag or Main Vertical Superflag output has been turned off due to an over-current condition.	Verify course guidance is valid and correct by crosschecking with the GTN on-screen CDI and other navigational equipment. Contact dealer for service.

Foreword

Getting Started

Audio & Xpdr Ctrl

Com/Nav

FPL

Direct-To

Proc

Charts

Wpt Info

Map

Traffic

Terrain

Weather

Nearest

Services/ Music

Utilities

System

Messages

Symbols

Appendix

Foreword
Getting Started
Audio & Xpdr Ctrl
Com/Nav
FPL
Direct-To
Proc
Charts
Wpt Info
Map
Traffic
Terrain
Weather
Nearest
Services/ Music
Utilities
System

Message	Description	Action
CDI SOURCE - Select appropriate CDI source for approach.	Aircraft is on a GPS approach but CDI is set to VLOC, or aircraft is on VLOC approach and CDI is set to GPS <i>and</i> aircraft is less than 2 nm from the FAF.	Select the appropriate CDI source for approach.
COM RADIO - Com locked to 121.5 MHz. Hold remote com transfer key to exit.	Com radio is locked to 121.5 MHz.	The external com remote transfer (COM RMT XFR) switch has been held and the com radio is tuned to 121.5. To exit this mode, hold the com remote transfer (COM RMT XFR) switch for two seconds.
COM RADIO - Com overtemp or undervoltage. Reducing transmitter power.	Com radio is in overtemp or undervoltage mode and transmitting power has been reduced to prevent damage to the com radio. Radio range will be reduced.	Decrease length of com transmissions, decrease cabin temperature and increase cabin airflow (especially near the GTN). Check aircraft voltage and reduce electrical load as necessary. Contact dealer for service if message persists.
COM RADIO - Com radio may be inoperative.	The com radio is not communicating properly with the system.	Press and hold the volume knob or the external com remote transfer (COM RMT XFR) switch, if installed – this will force the com radio to 121.5 MHz. Contact dealer for service.
COM RADIO - Com radio needs service.	The com radio is reporting that it needs service. The com radio may continue to function.	Cycle the power to the COM radio. Contact dealer for service.

Messages

Symbols

Appendix

Message	Description	Action
CONFIGURATION - Terrain/TAWS configuration is invalid. GTN needs service.	TAWS is inoperative due to a configuration problem with the GTN. This message will be accompanied by a TER FAIL annunciation.	Contact dealer for service.
CONFIGURATION MODULE - GTN configuration module needs service.	The GTN cannot communicate with its configuration module. The GTN may still have a valid configuration.	Contact dealer for service.
COOLING - GTN overtemp. Reducing backlight brightness.	Backlight brightness has been reduced due to high display temperatures. The backlight level will remain high enough to be visible in daylight conditions.	Decrease cabin temperature and increase cabin airflow (especially near the GTN). Contact dealer for service if message persists.
COOLING FAN - The cooling fan has failed.	The GTN cooling fan is powered, but it is not turning at the desired RPM.	Decrease cabin temperature and increase cabin airflow (especially near the GTN) to prevent damage to the unit. Contact dealer for service.
CROSSFILL ERROR - Crossfill is inoperative. See CRG for crossfilled items.	Crossfill is not working due to loss of communication with other GTN or due to one GTN needing service.	See section 16.4.6.1 for a list of crossfilled items that will no longer be crossfilled. Contact dealer for service.
CROSSFILL ERROR - GTN Navigation DB mismatch. See CRG for crossfilled items.	The navigation databases do not match between GTNs resulting in a loss of communication between two units.	Check the specified database version of both GTNs and ensure it is up-to-date. Update the specified database if needed.

Foreword

Getting Started

Audio & Xpdr Ctrl

Com/Nav

FPL

Direct-To

Proc

Charts

Wpt Info

Map

Traffic

Terrain

Weather

Nearest

Services/ Music

Utilities

System

Messages

Symbols

Appendix

Foreword
Getting Started
Audio & Xpdr Ctrl
Com/Nav
FPL
Direct-To
Proc
Charts
Wpt Info
Map
Traffic
Terrain
Weather
Nearest
Services/
Music
Utilities
System
Messages

Message	Description	Action
CROSSFILL ERROR - GTN software mismatch. See CRG for crossfilled items.	Crossfill is configured "on" but is not working due to software mismatch.	See section 16.4.6.1 for a list of crossfilled items that will no longer be crossfilled. Contact dealer to have software versions updated.
CROSSFILL STATUS - Crossfill is turned off.	Crossfill is turned off.	No action.
DATABASE - A procedure has been modified in a cataloged flight plan.	A new database update caused a procedure to be truncated because the flight plan now has too many waypoints or removed a procedure because it no longer exists in the database.	Verify stored cataloged flight plans and procedures. Modify stored flight plans and procedures as necessary to include the current procedures by re-loading those procedures to the stored flight plan routes.
DATABASE - Chart database valid until [DATE].	The GTN is configured for ChartView or FliteCharts and the chart database has or is about to expire.	Verify chart database expiration date on the System – System Status page. Update chart database if necessary for operations.
DATABASE - Chart function unavailable.	The GTN is configured for ChartView or FliteCharts and chart verification has failed.	Contact dealer for service.
DATABASE - Terrain database is not installed, is corrupt, or is not valid for this system.	The terrain database is not available. Terrain information and alerts do not display.	Re-load the database on the external datacard.

Symbols
Appendix

Message	Description	Action
DATABASE - Terrain display unavailable for current location.	The aircraft is outside the terrain database coverage area.	Terrain and TAWS functions will be unavailable. If terrain coverage is desired in the area, load appropriate coverage area on the external datacard.
DATABASE - Terrain or Obstacle database not available.	The terrain or obstacle database is missing or corrupt.	Re-load these databases on the external datacard.
DATABASE - Verify airways in stored flight plans are correct.	A stored flight plan contains an airway that is no longer consistent with the current navigation database.	Verify that the airways in stored flight plans are correct. Modify stored flight plans as necessary to include the current airways by re-loading those airways to the stored flight plan routes.
DATABASE - Verify user-modified procedures in stored flight plans are correct.	A stored flight plan contains procedures that have been manually updated, and a navigation database update has occurred.	Verify that the user-modified procedures in stored flight plans are correct.
DATACARD ERROR - SD card is invalid or failed.	External datacard has an error and the unit is not able to read the databases.	ChartView, FlightCharts, and Terrain databases will not be accessible by the unit. Contact dealer for service.
DATACARD REMOVED - Reinsert SD card.	External datacard was removed.	Reinsert datacard.
DATALINK - ADS-B In fault: UAT receiver.	The ADS-B In source has detected a UAT receiver fault.	Contact dealer for service.
DATALINK - ADS-B In fault: 1090 receiver.	The ADS-B In source has detected a 1090 receiver fault.	Contact dealer for service.

Foreword

Getting Started

Audio & Xpdr Ctrl

Com/Nav

FPL

Direct-To

Proc

Charts

Wpt Info

Map

Traffic

Terrain

Weather

Nearest

Services/ Music

Utilities

System

Messages

Symbols

Appendix

Foreword

Getting Started

Audio & Xpdr Ctrl

Com/Nav

FPL

Direct-To

Proc

Charts

Wpt Info

Map

Traffic

Terrain

Weather

Nearest

Services/
Music

Utilities

System

Messages

Symbols

Appendix

Index

17-8

GTN 725/750 Pilot's Guide

190-01007-03 Rev. R

Message	Description	Action
DATALINK - FIS-B weather has failed.	The FIS-B receiver is reporting that it has failed. The display of FIS-B products may be unavailable.	Contact dealer for service.
DATALINK - GDL 69 is inoperative or connection to GTN is lost.	The GTN is configured for a Garmin datalink (GDL 69 or 69A) and the GTN cannot communicate with the datalink. Data from the datalink will not be available.	Contact dealer for service.
DATALINK - GDL 88 ADS-B failure. Unable to transmit ADS-B messages.	GDL 88 is not able to transmit an ADS-B message due to a failure with the GDL 88 system or antenna(s).	Contact dealer for service.
DATALINK - GDL 88 ADS-B fault.	The GDL 88 has detected a fault with one of the GDL 88 UAT/1090 antennas.	Contact dealer for service.
DATALINK - GDL 88 ADS-B fault. Pressure altitude input is invalid.	The GDL 88 has lost communication with the pressure altitude source.	Contact dealer for service.
DATALINK - GDL 88 ADS-B is not transmitting position. Check GPS devices.	The GDL 88 has detected a position input fault.	Contact dealer for service.

Message	Description	Action
DATALINK - GDL 88 configuration module needs service.	The GDL 88 has detected a configuration module fault.	Contact dealer for service.
DATALINK - GDL 88 control input fault. Check transponder is in correct mode.	The GDL 88 has lost communication with the transponder.	Contact dealer for service.
DATALINK - GDL 88 is inoperative or connection to GTN is lost.	The GTN is configured for a Garmin datalink (GDL 88) and the GTN cannot communicate with the datalink. Data from the datalink will not be available.	Contact dealer for service.
DATALINK - GDL 88 needs service.	GDL 88 has detected an internal fault.	Contact dealer for service.
DATALINK - GSR 56 data services inoperative; registration required.	The GSR 56 is not registered. GSR Weather, Position Reporting, and Phone Services will be unavailable.	Contact dealer for service.
DATALINK - GSR 56 is inoperative or connection to GTN is lost.	The GTN is configured for a Garmin GSR 56 and the GTN cannot communicate with the GSR 56. GSR Weather, Position Reporting, and Phone Services will be unavailable.	Close the GSR 56 circuit breaker and ensure the GSR 56 is receiving power. Contact dealer for service.

- Foreword
- Getting Started
- Audio & Xpdr Ctrl
- Com/Nav
- FPL
- Direct-To
- Proc
- Charts
- Wpt Info
- Map
- Traffic
- Terrain
- Weather
- Nearest
- Services/Music
- Utilities
- System
- Messages**
- Symbols
- Appendix

	Message	Description	Action
Foreword Getting Started Audio & Xpdr Ctrl	DATA LOST - Pilot stored data was lost. Recheck settings.	User settings such as map detail level, nav range ring on/off, traffic overlay on/off, and alert settings have been lost.	Recheck settings.
Com/Nav FPL	DATA SOURCE - Heading source inoperative or connection to GTN lost.	The GTN is configured to receive heading information but is not receiving it from any source.	Heading up map displays will not be available. Contact dealer for service.
Direct-To Proc Charts Wpt Info	DATA SOURCE - Pressure altitude source inoperative or connection to GTN lost.	The GTN is configured to receive pressure altitude but is not receiving it from any source.	If the GTN is being used to forward pressure altitude to a transponder, the transponder will not be receiving pressure altitude from the GTN while that message is present. Contact dealer for service.
Map Traffic Terrain	DATA SOURCE - Radar Altimeter source inoperative or connection to GTN lost.	The GTN is configured to receive radio altitude information but is not receiving it from any source.	50 foot aural annunciation is unavailable for HTAWS installations. Contact dealer for service.
Weather Nearest	DEMO MODE - Demo mode is active. Do not use for navigation.	The GTN is in Demo Mode and must not be used for actual navigation.	Do not use for navigation. Power cycle the GTN to exit demo mode. Also ensure that the Direct-To key is not stuck.
Services/ Music Utilities System	FLIGHT PLAN IMPORT - Flight plan import failed.	The requested flight plan could not be imported because the GTN was unable to decode the contents of the flight plan.	Check for proper operation of the needed components. Contact dealer for service if problem persists.
Messages Symbols Appendix	FLIGHT PLAN IMPORT - Flight plan import failed. Catalog is full.	The flight plan catalog is full and the requested flight plan could not be imported.	Edit the flight plan catalog to remove unneeded flight plans.

Message	Description	Action
FLIGHT PLAN IMPORT - New imported flight plan(s) available for preview.	The GTN has received a new flight plan that is available for preview by the pilot.	No action is necessary; message is informational only.
FLIGHT PLAN IMPORT - Changes to the active route are disabled.	Unit receives a flight plan from G3X Touch, but the External FPL Crossfill function is off.	Enable the External FPL Crossfill function. Home > System > Setup > External FPL Xfill .
FLIGHT PLAN IMPORT - GDU disconnected. External flight plan crossfill inoperative.	Communication with the G3X Touch is lost.	Verify that the GDU is on. Contact dealer for service.
FPL WAYPOINT LOCKED - Stored flight plan waypoint is not in current navigation database.	A stored flight plan waypoint is no longer in the current navigation database.	Verify stored cataloged flight plans and procedures. Modify stored flight plans as necessary to include waypoints that are in the current navigation database.
FPL WPT MOVED - Stored flight plan waypoint has changed location.	A stored flight plan waypoint has moved by more than 0.33 arc minutes from where previously positioned.	Verify stored cataloged flight plans and procedures. Modify stored flight plans as necessary to include waypoints that are in the current navigation database.
GLIDESLOPE - Glideslope receiver has failed.	The glideslope board is not communicating properly with the system.	Fly an approach that does not use the glideslope receiver (VOR, LOC, GPS). Contact dealer for service.

Foreword

Getting Started

Audio & Xpdr Ctrl

Com/Nav

FPL

Direct-To

Proc

Charts

Wpt Info

Map

Traffic

Terrain

Weather

Nearest

Services/ Music

Utilities

System

Messages

Symbols

Appendix

Foreword
Getting Started
Audio & Xpdr Ctrl
Com/Nav
FPL
Direct-To
Proc
Charts
Wpt Info
Map
Traffic
Terrain
Weather
Nearest
Services/Music
Utilities
System
Messages
Symbols

Message	Description	Action
GLIDESLOPE - Glideslope receiver needs service.	The glideslope board is indicating that it needs service. The glideslope board may continue to function.	Verify glideslope deviation indications with another source and crosscheck final approach fix crossing altitude. If another glideslope source is not available for verification, fly a GPS based approach. Contact dealer for service.
GNS CROSSFILL - Catalog full; not all GNS waypoint(s) transferred.	A user waypoint from the GNS could not be created because the user waypoint catalog is full.	Remove some of the waypoints from the catalog to make room for the waypoints from the GNS.
GNS CROSSFILL - GTN user waypoint(s) replaced with GNS user waypoints.	A user waypoint from the GNS replaced one or more existing waypoints on the GTN.	Ensure that the waypoints on the GNS have unique names before transferring to the GTN to avoid overwriting existing waypoints.
GNS CROSSFILL - Waypoint transfer failed.	Waypoint transfer failed/incomplete.	The data transfer should be reattempted.
GPS NAVIGATION LOST - Erroneous position. Use other navigation source.	GPS position has been lost due to erroneous position.	Use a different GPS receiver or a non-GPS based source of navigation. Contact dealer for service.
GPS NAVIGATION LOST - Insufficient satellites. Use other navigation source.	GPS position has been lost due to lack of satellites.	Wait for GPS satellite geometry to improve. Ensure the aircraft has a clear view of the sky. Use a different GPS receiver or a non-GPS based source of navigation. Contact dealer for service.

Appendix

Message	Description	Action
GPS RECEIVER - GPS receiver has failed. Check GPS coax for electrical short.	Internal communication to the SBAS board is inoperative.	Use a different GPS receiver or a non-GPS based source of navigation. Contact dealer for service.
GPS RECEIVER - GPS receiver needs service.	The GPS module is reporting that it needs service. The GPS module may continue to function.	Use a different GPS receiver or a non-GPS based source of navigation. Contact dealer for service.
GPS RECEIVER - Low internal clock battery.	The GPS module indicates that its clock battery is low. Almanac data may have been lost. The unit will function normally, but may take a longer than normal period to acquire a GPS position.	Contact dealer for service.
GPS SEARCHING SKY - Ensure GPS antenna has an unobstructed view of the sky.	The GPS module is acquiring position and may take longer than normal. This message normally occurs after initial installation or if the unit has not been powered for several weeks.	No action is necessary; message is informational only.
GTN - GTN needs service.	The GTN has lost calibration data that was set by Garmin during manufacturing.	Contact dealer for service.
HOLD EXPIRED - Holding EFC time has expired.	The selected Expect Further Clearance (EFC) time for a user-defined hold has passed.	No action is necessary; message is information only.

Foreword

Getting Started

Audio & Xpdr Ctrl

Com/Nav

FPL

Direct-To

Proc

Charts

Wpt Info

Map

Traffic

Terrain

Weather

Nearest

Services/ Music

Utilities

System

Messages

Symbols

Appendix

	Message	Description	Action
Foreword	HTAWS - Invalid Terrain Database.	The terrain database is of insufficient resolution for use with HTAWS.	Load HTAWS specific terrain database on the external SD card.
Getting Started	INTERFACE ADAPTER - GAD 42 configuration needs service.	GAD 42 indicates a configuration error.	Verify all input/output data from/to the GAD 42 Interface Adapter. Contact dealer for service.
Audio & Xpdr Ctrl			
Com/Nav			
FPL			
Direct-To	INTERFACE ADAPTER - GAD 42 needs service.	GAD 42 indicates it needs service. The GAD 42 may continue to function.	Verify all input/output data from/to the GAD 42 Interface Adapter. Contact dealer for service.
Proc			
Charts	INTERNAL SD CARD ERROR - GTN needs service.	Internal SD card has an error. This card is not accessible by the user.	Contact dealer for service.
Wpt Info			
Map	INTERNAL SD CARD REMOVED - GTN needs service.	Internal SD card was removed or failed. This card is not accessible by the user.	Contact dealer for service.
Traffic			
Terrain	KEY STUCK - Direct-To key is stuck.	The Direct-To key has been in pressed position for at least 30 seconds. This key will now be ignored.	Verify the Direct-To key is not pressed. Contact dealer for service if message persists.
Weather			
Nearest			
Services/ Music	KEY STUCK - HOME key is stuck.	The HOME key has been in pressed position for at least 30 seconds. This key will now be ignored.	Verify the HOME key is not pressed. Press the Home key again to cycle its operation. Contact dealer for service if message persists.
Utilities			
System	KNOB STUCK - Dual concentric inner knob is stuck in the pressed position.	The dual concentric inner knob has been in pressed position for at least 30 seconds. This knob press will now be ignored.	Verify the dual concentric knob is not pressed. Contact dealer for service if message persists.
Messages			
Symbols			
Appendix			

Message	Description	Action
KNOB STUCK - Volume knob is stuck in the pressed position.	The Volume knob has been in pressed position for at least 30 seconds. This knob press will now be ignored.	Verify the volume knob is not pressed. Contact dealer for service if message persists.
LOCKED FLIGHT PLAN Cannot activate a flight plan containing a locked waypoint.	The user is trying to activate a flight plan that contains a locked waypoint.	Unlock the flight plan by modifying stored flight plans as necessary to include waypoints, procedures, and airways that are in the current navigation database.
LOSS OF INTEGRITY (LOI)- Verify GPS position with other navigation equipment.	Antenna may be shaded from satellites. The GPS module has reported a loss of integrity.	Make sure the aircraft is clear of hangars, buildings, trees, etc. Use a different GPS receiver or a non-GPS based source of navigation. Contact dealer for service if message persists.
MAGNETIC NORTH APPROACH - Verify NAV angles are referenced to magnetic north (magnetic variation).	The NAV angle is not set to Magnetic and a magnetic approach is loaded.	Change NAV angle setting to Magnetic.
MAGNETIC VARIATION - Aircraft in area with large mag var. Verify all course angles.	MagVar is flagged as unreliable in the MagVar database. This normally occurs when operating at high latitudes that do not support a Nav Angle of Magnetic.	Verify that the geographical region supports navigation based on magnetic variation.

Foreword

Getting Started

Audio & Xpdr Ctrl

Com/Nav

FPL

Direct-To

Proc

Charts

Wpt Info

Map

Traffic

Terrain

Weather

Nearest

Services/ Music

Utilities

System

Messages

Symbols

Appendix

	Message	Description	Action
Foreword Getting Started Audio & Xpdr Ctrl Com/Nav	MARK ON TARGET - Waypoint creation has failed. MOT requires GPS position.	Mark on target waypoint creation has failed because of missing GPS position.	Wait for GPS satellite geometry to improve. Ensure the aircraft has a clear view of the sky. Reattempt waypoint creation. Contact dealer for service.
FPL Direct-To	NAV ANGLE - NAV Angles are referenced to a User set value (U).	Nav angle is set to User.	No action is necessary; message is informational only.
Proc Charts	NAV ANGLE - NAV Angles are referenced to True North (T).	Nav angle is set to True.	No action is necessary; message is informational only.
Wpt Info Map Traffic Terrain	NON-WGS84 WAYPOINT - See CRG. Location may be different than where surveyed for [WPT].	The active waypoint is not referenced to the WGS84 datum. See Note 1 at the end of the table.	No action is necessary; message is informational only.
Weather Nearest Services/ Music	OBS - OBS is not available due to dead reckoning or no active waypoint.	OBS requires an active waypoint and is not supported in dead reckoning mode.	No action is necessary; message is informational only.
Utilities System	PARALLEL TRACK - Parallel track not supported for leg type.	Parallel track is not supported on current leg type.	No action is necessary; message is informational only.
Messages Symbols Appendix	PARALLEL TRACK - Parallel track not supported for turns greater than 120 degrees.	Parallel track is not supported for turns greater than 120 degrees due to the acute angle.	No action is necessary; message is informational only.

Message	Description	Action
PARALLEL TRACK - Parallel track not supported past IAF.	Parallel track is not supported on approaches.	No action is necessary; message is informational only.
REMOTE KEY STUCK - Alert Acknowledge key is stuck.	The remote TAWS alert acknowledge (ALRT ACK) key/switch has been in pressed position for at least 30 seconds. This input will now be ignored. This input is not available in all installations.	Verify the ALRT ACK key/switch is not stuck. Contact dealer for service if message persists.
REMOTE KEY STUCK - Com push-to-talk key is stuck.	The Push To Talk key/switch has been in pressed position for at least 30 seconds. This input will now be ignored and the com radio will no longer transmit.	Verify the Push To Talk key/switch is not stuck. Contact dealer for service if message persists.
REMOTE KEY STUCK - Com remote frequency decrement key is stuck.	The remote com frequency decrement (COM CHAN DN) key/switch has been in pressed position for at least 30 seconds. This input will now be ignored. This input is not available in all installations.	Verify the COM CHAN DN key/switch is not stuck. Contact dealer for service if message persists.

Foreword

Getting Started

Audio & Xpdr Ctrl

Com/Nav

FPL

Direct-To

Proc

Charts

Wpt Info

Map

Traffic

Terrain

Weather

Nearest

Services/ Music

Utilities

System

Messages

Symbols

Appendix

Foreword
Getting Started
Audio & Xpdr Ctrl
Com/Nav
FPL
Direct-To
Proc
Charts
Wpt Info
Map
Traffic
Terrain
Weather
Nearest
Services/ Music
Utilities
System
Messages
Symbols

Message	Description	Action
REMOTE KEY STUCK - Com remote frequency increment key is stuck.	The remote com frequency increment (COM CHAN UP) key/switch has been in pressed position for at least 30 seconds. This input will now be ignored. This input is not available in all installations.	Verify the COM CHAN UP key/switch is not stuck. Contact dealer for service if message persists.
REMOTE KEY STUCK - Com remote transfer key is stuck.	The remote com transfer (COM RMT XFR) key/switch has been in pressed position for at least 30 seconds. This input will now be ignored. This input is not available in all installations.	Verify the COM RMT XFR key/switch is not stuck. Contact dealer for service if message persists.
REMOTE KEY STUCK - Nav remote transfer key is stuck.	The remote nav transfer (NAV RMT XFR) key/switch has been in pressed position for at least 30 seconds. This input will now be ignored. This input is not available in all installations.	Verify the NAV RMT XFR key/switch is not stuck. Contact dealer for service if message persists.
REMOTE KEY STUCK - Pilot/Co-Pilot voice command push-to-command key is stuck.	The remote push-to-command key/switch has been in pressed position for at least 30 seconds. This input will now be ignored. This input is not available in all installations.	Verify the push-to-command key/switch is not stuck. Contact dealer for service if message persists.

Appendix

Message	Description	Action
REMOTE KEY STUCK - Remote CDI key is stuck.	The remote CDI (CDI SRC SEL) key/switch has been in pressed position for at least 30 seconds. This input will now be ignored. This input is not available in all installations.	Verify the CDI SRC SEL key/switch is not stuck. Contact dealer for service if message persists.
REMOTE KEY STUCK - Remote go around key is stuck.	The remote go around (RMT GO ARND) key/switch has been in pressed position for at least 30 seconds. This input will now be ignored. This input is not available in all installations.	Verify the RMT GO ARND key/switch is not stuck. Contact dealer for service if message persists.
REMOTE KEY STUCK - Remote OBS key is stuck.	The remote OBS (OBS MODE SEL) key/switch has been in pressed position for at least 30 seconds. This input will now be ignored. This input is not available in all installations.	Verify the OBS MODE SEL key/switch is not stuck. Contact dealer for service if message persists.
REMOTE KEY STUCK - RP Mode key is stuck.	The remote RP MODE key/switch has been in pressed position for at least 30 seconds. This input will now be ignored. This input is not available in all installations.	Verify the RP MODE key/switch is not stuck. Contact dealer for service if message persists.

Foreword

Getting Started

Audio & Xpdr Ctrl

Com/Nav

FPL

Direct-To

Proc

Charts

Wpt Info

Map

Traffic

Terrain

Weather

Nearest

Services/ Music

Utilities

System

Messages

Symbols

Appendix

Foreword

Getting Started

Audio & Xpdr Ctrl

Com/Nav

FPL

Direct-To

Proc

Charts

Wpt Info

Map

Traffic

Terrain

Weather

Nearest

Services/
Music

Utilities

System

Messages

Symbols

Appendix

Index

17-20

GTN 725/750 Pilot's Guide

190-01007-03 Rev. R

Message	Description	Action
REMOTE KEY STUCK - TAWS inhibit key is stuck.	The TAWS INHIBIT discrete input has been in pressed position for at least 30 seconds. This input will now be ignored. This input is not available in all installations.	Verify the TAWS INHIBIT key/switch is not stuck. Contact dealer for service if message persists.
SELECT FREQUENCY - Select appropriate NAV frequency for approach.	Correct NAV frequency is not set in the active NAV frequency for the approach procedure.	Insert the correct frequency into the active navigation frequency window.
SET COURSE - Set course on CDI/HSI to [current DTK].	The selected course on the CDI/HSI does not match the current desired track.	Set the CDI/HSI selected course to the current desired track.
STEEP TURN - Aircraft may overshoot course during turn.	Flight plan contains an acute course change ahead which will require a bank in excess of normal to follow the guidance. If coupled to the autopilot, the autopilot may not be able to execute the steep turn needed to follow the course guidance.	No action is necessary; message is informational only. If desired, slow the aircraft to shallow the turn.
STORMSCOPE - Invalid heading received from StormScope.	The WX-500 StormScope reports that it has an invalid heading source.	GTN StormScope data is correct and may be used. Contact dealer for service.

Message	Description	Action
STORMSCOPE - StormScope is inoperative or connection to GTN is lost.	The GTN is configured for a WX-500 StormScope but is not receiving data from it.	Close the Stormscope circuit breaker and ensure Stormscope is receiving power. Contact dealer for service.
TAWS AUDIO INHIBITED - TAWS audio inhibit input is stuck.	The TAWS Audio Inhibit discrete input has been active for at least 30 seconds. This input is active in all installations. TAWS audio may be heard at the same time as other audio alerts.	Contact dealer for service.
TIMER - Timer has expired.	A user-configured timer has expired.	No action is necessary; message is informational only.
TRAFFIC - ADS-B In traffic alerting has failed.	The ADS-B traffic system is reporting to the GTN that the CSA application has failed. Traffic alerting on ADS-B traffic is unavailable.	Ensure the aircraft has a clear view of the sky. Contact dealer for service if problem persists.
TRAFFIC - ADS-B In traffic has failed.	The ADS-B traffic system may have lost GPS position or detected an internal fault.	Contact dealer for service.
TRAFFIC - TCAD has a low battery.	The GDL 88 is reporting that the external traffic system has a low battery.	Contact dealer for service.

Foreword

Getting Started

Audio & Xpdr Ctrl

Com/Nav

FPL

Direct-To

Proc

Charts

Wpt Info

Map

Traffic

Terrain

Weather

Nearest

Services/ Music

Utilities

System

Messages

Symbols

Appendix

Foreword
Getting Started
Audio & Xpdr Ctrl
Com/Nav
FPL
Direct-To
Proc
Charts
Wpt Info
Map
Traffic
Terrain
Weather
Nearest
Services/
Music
Utilities
System

Message	Description	Action
TRAFFIC - Traffic device battery low. Traffic device user config settings not saved.	The TCAD system has indicated that its battery is low.	Contact dealer for service.
TRAFFIC - Traffic device has been in standby for more than 60 seconds.	The GTN is airborne and the traffic device has been in standby for more than 60 seconds.	Set the traffic device to “operate” on the traffic page if traffic alerts are desired.
TRAFFIC - Traffic device is inoperative or connection to GTN is lost.	The GTN is configured for a traffic device but is not receiving data from it. Traffic will not be displayed on the GTN.	Contact dealer for service.
TRANSPONDER - Transponder 1 and 2 Mode S addresses do not match.	The GTN is configured for two transponders and their Mode S addresses do not match. This message is intended to assist installers and will not occur in a properly configured system.	Contact dealer for service.
TRANSPONDER 1 OR 2 - ADS-B is not transmitting position.	The transponder has insufficient data to support ADS-B.	Ensure the aircraft has a clear view of the sky. Contact dealer for service.

Messages

Symbols

Appendix

Message	Description	Action
TRANSPONDER 1 OR 2 - ADS-B Out system fault. Pressure altitude source inoperative or connection lost.	The transponder has lost communication with the pressure altitude source.	Contact dealer for service.
TRANSPONDER 1 OR 2 - Transponder 1 or 2 is inoperative or connection to GTN is lost.	The GTN is configured for transponder 1 or 2 but is not able to communicate with the transponder.	Verify squawk code and altitude with ATC. Contact dealer for service.
TRANSPONDER 1 OR 2 - Transponder 1 or 2 needs service.	The transponder is reporting to the GTN that it needs service. The transponder may continue to function.	Verify squawk code and altitude with ATC. Contact dealer for service.
TRANSPONDER 1 OR 2 - Transponder has failed.	The transponder has detected an internal fault and transponder functionality may be unavailable.	Contact dealer for service.
TRANSPONDER 1 OR 2 - Transponder is in ground test mode.	The transponder is operating in a mode intended for ground testing.	Cycle the power to the transponder.
TRANSPONDER 1 OR 2 - Transponder overtemp.	The transponder is reporting that its internal temperature has exceeded upper operating limits.	Decrease temperature and increase airflow near the transponder, if possible. Monitor aircraft electrical indications. Contact dealer for service if message persists.

- Foreword
- Getting Started
- Audio & Xpdr Ctrl
- Com/Nav
- FPL
- Direct-To
- Proc
- Charts
- Wpt Info
- Map
- Traffic
- Terrain
- Weather
- Nearest
- Services/ Music
- Utilities
- System
- Messages**
- Symbols
- Appendix

	Message	Description	Action
Foreword Getting Started Audio & Xpdr Ctrl	TRANSPONDER 1 OR 2 - Transponder undertemp.	The transponder is reporting that its internal temperature has exceeded lower operating limits.	Contact dealer for service if message persists.
Com/Nav FPL Direct-To	TRUE NORTH APPROACH - Verify NAV Angles are referenced to True North (T).	A procedure is loaded that is referenced to true north and the active leg has a published true north reference.	Verify the Nav Angle is set to True North.
Proc Charts Wpt Info	USER WAYPOINT IMPORT - User waypoints were imported successfully.	All user waypoints were imported successfully.	No action is necessary; message is informational only.
Map Traffic Terrain	USER WAYPOINT IMPORT - User waypoint import failed.	User Waypoint import failed due to improper file format.	Ensure the media has the correct file format. Contact dealer for service if problem persists.
Weather Nearest Services/ Music	USER WAYPOINT IMPORT - User waypoint import failed. User waypoint database is full.	User Waypoint catalog is full and the requested user waypoints could not be imported.	Edit the User Waypoint catalog to remove unneeded user waypoints.
Utilities System Messages	USER WAYPOINT IMPORT - User waypoints imported successfully - existing waypoints reused.	User waypoints imported and existing waypoints are used instead of creating duplicate waypoints.	No action is necessary; message is informational only.

Symbols

Appendix

Message	Description	Action
VCALC - Approaching top of descent.	User has configured a vertical descent calculation, and the aircraft is within 60 seconds of the calculated top of descent.	No action is necessary; message is informational only.
VCALC - Arriving at VCALC target altitude.	User has configured a vertical descent calculation, and the aircraft is approaching the target altitude.	No action is necessary; message is informational only.
VISUAL APPROACH NOT ACTIVE - Approach guidance not available when requesting Direct-To runway.	Visual approach could not transition to active. Guidance is not available.	Reactivate the approach or cancel the Direct-To course.
VLOC RECEIVER - Navigation receiver has failed.	The nav radio is not communicating properly with the system.	Use GPS based navigation. Contact dealer for service.
VLOC RECEIVER - Navigation receiver needs service.	The nav radio is reporting to the GTN that it needs service. The nav radio may continue to function.	Use GPS based navigation. Contact dealer for service.
VNAV - Unable to reach vertical waypoint.	Current altitude constraint cannot be reached based on current ground and vertical speeds.	Attempt to intercept vertical path by adjusting aircraft altitude.

Foreword

Getting Started

Audio & Xpdr Ctrl

Com/Nav

FPL

Direct-To

Proc

Charts

Wpt Info

Map

Traffic

Terrain

Weather

Nearest

Services/ Music

Utilities

System

Messages

Symbols

Appendix

	Message	Description	Action
Foreword	VNAV - Unavailable. Upcoming flight plan leg not supported.	The lateral flight plan contains a procedure turn, vector, or other unsupported leg type prior to the active vertical waypoint.	Treat the flight plan segments before and after the affected leg as separate vertical profiles. The GTN cannot provide automatic guidance between the two segments.
Getting Started			
Audio & Xpdr Ctrl			
Com/Nav			
FPL	VNAV - Unavailable. Excessive crosstrack error.	Current crosstrack exceeds limit, causing vertical path guidance to become invalid.	Navigate within 10 nm of flight plan centerline, or edit flight plan to allow for vertical navigation.
Direct-To			
Proc	VNAV - Unavailable. Excessive track angle error.	Current track angle error exceeds limit, causing vertical path guidance to become invalid.	Navigate within 70° of active flight plan course.
Charts			
Wpt Info			
Map	VNAV - Unavailable. Parallel course selected.	Selecting a parallel course causes vertical path guidance to become invalid.	Disable parallel track if vertical path guidance is desired.
Traffic			
Terrain	VNAV - Unavailable. Barometric altitude lost.	A loss of data from the barometric altitude sensor causes vertical path guidance to become invalid.	Contact dealer for service.
Weather			
Nearest			
Services/ Music	WAYPOINT - Arriving at [wpt name].	User has configured the arrival alarm and is within the specified distance.	No action is necessary; message is informational only.
Utilities			
System	WX ALERT - Possible severe weather ahead.	The weather radar system is indicating the presence of severe weather ahead.	Check weather radar. See section 12.4.7.2 for more information.
Messages			

Symbols

Appendix

Message	Description	Action
WX RADAR FAIL - Weather radar is inoperative.	The GTN is configured for a weather radar but is not receiving data from it. Weather Radar will not be displayed on the GTN.	Contact dealer for service.
WX RADAR SERVICE - Weather radar needs service. Return unit for repair.	Weather radar is reporting a system fault.	Contact dealer for service.

Table 17-1 Messages

Note 1: There are several reference datums that waypoints can be surveyed against. TSO-C146 normally requires that all waypoints be referenced to the WGS84 datum, but allows for navigation to waypoints that are not referenced to the WGS84 datum so long as the pilot is notified. Certain waypoints in the navigation database are not referenced to the WGS84 datum, or their reference datum is unknown. If this is the case, this message is displayed. Garmin cannot determine exactly how close the non-WGS84 referenced waypoint will be to the WGS84 datum that the GTN uses. Typically, the distance is within two nautical miles. The majority of non-WGS84 waypoints are located outside of the United States.

- Foreword
- Getting Started
- Audio & Xpdr Ctrl
- Com/Nav
- FPL
- Direct-To
- Proc
- Charts
- Wpt Info
- Map
- Traffic
- Terrain
- Weather
- Nearest
- Services/Music
- Utilities
- System
- Messages**
- Symbols
- Appendix

Foreword

Getting
Started

Audio &
Xpdr Ctrl

Com/Nav

FPL

Direct-To

Proc

Charts

Wpt Info

Map

This page intentionally left blank

Traffic

Terrain

Weather

Nearest

Services/
Music

Utilities

System

Messages

Symbols

Appendix

18 SYMBOLS

The following tables describe the symbols that are found on the Map display.

18.1 Map Page Symbols





















Symbol	Description	Symbol	Description
	Airport with hard surface runway(s); Non-Serviced, Primary runway shown		Airport with hard surface runway(s); Serviced, Primary runway shown
	Airport with soft surface runway(s) only, Non-Serviced		Airport with soft surface runway(s) only, Serviced
	Restricted (Private) Airfield		Unknown Airport
	Heliport		NDB
	Intersection		Locator Outer Marker
	VOR		VOR/DME
	VORTAC		DME
	TACAN		TOD/BOD
	User Waypoint		User Airport
	ATK		VRP

Table 18-1 Map Page Symbols

18.2 SafeTaxi™ Symbols





Symbol	Description
	Helipad
	Airport Beacon
	Under Construction Zones
	Unpaved Parking Areas
	Hot Spot

Table 18-2 SafeTaxi Symbols

18.3 Traffic Symbols



TIS Symbol	Description
	Non-Threat Traffic
	Traffic Advisory (TA)
	Traffic Advisory Off Scale

Table 18-3 TIS Symbols

Foreword
Getting Started
Audio & Xpdr Ctrl
Com/Nav
FPL
Direct-To
Proc
Charts
Wpt Info
Map
Traffic
Terrain
Weather
Nearest
Services/
Music
Utilities
System
Messages
Symbols
Appendix
Index





TAS Symbol	Description
	Non-Threat Traffic (intruder is beyond 5 NM and greater than 1200 ft vertical separation)
	Proximity Advisory (PA) (intruder is within 5 NM and less than 1200 ft vertical separation)
	Traffic Advisory (TA) (closing rate, distance, and vertical separation meet TA criteria)
	Traffic Advisory Off Scale

Table 18-4 TAS Symbols







Symbol		Description
Imminent Traffic (Traffic within ±500 feet AND 1.0 NM; OR no altitude AND within 1.0 NM)	Non-Imminent Traffic	
		Traffic Closing Vertically
		Traffic Diverging Vertically
		Traffic not Closing or Diverging Vertically

Table 18-5 9900B TCAD Symbols





Symbol	Description
	Traffic Advisory
	Proximity Advisory (color may be configured as cyan)
	Other Traffic (color may be configured as cyan)
	Out-of-Range Traffic Advisory

Table 18-6 9900BX (TCAS) Symbols













	Symbol	Description
Foreword		Basic Non-Directional Traffic
Getting Started		Basic Directional Traffic
Audio & Xpdr Ctrl		Basic Off-scale Selected Traffic
Com/Nav		Proximate Non-Directional Traffic
FPL		Proximate Directional Traffic
Direct-To		Proximate Off-scale Selected Traffic
Proc		Non-Directional Alerted Traffic
Charts		Off-Scale Non-Directional Alerted Traffic
Wpt Info		Directional Alerted Traffic
Map		Off-Scale Directional Alerted Traffic
Traffic		Non-Directional Surface Vehicle
Terrain		Directional Surface Vehicle

Table 18-7 ADS-B Traffic Symbols



NOTE: Color of basic and proximate traffic is dependent on configuration (cyan or white) and airborne/on-ground status of target (target is brown when on the ground, see the surface vehicles).

- Foreword
- Getting Started
- Audio & Xpdr Ctrl
- Com/Nav
- FPL
- Direct-To
- Proc
- Charts
- Wpt Info
- Map
- Traffic
- Terrain
- Weather
- Nearest
- Services/Music
- Utilities
- System
- Messages
- Symbols**
- Appendix

18.4 Terrain Obstacle Symbols





Unlighted Obstacle (Height is less than 1000 ft AGL)	Lighted Obstacle (Height is less than 1000 ft AGL)	Unlighted Obstacle (Height is greater than 1000 ft AGL)	Lighted Obstacle (Height is greater than 1000 ft AGL)
			

Table 18-8 Obstacle Altitude/Color Correlation





Tower	Windmill	Windmill in Group	Power Line
			

Table 18-9 Obstacle Icon Types

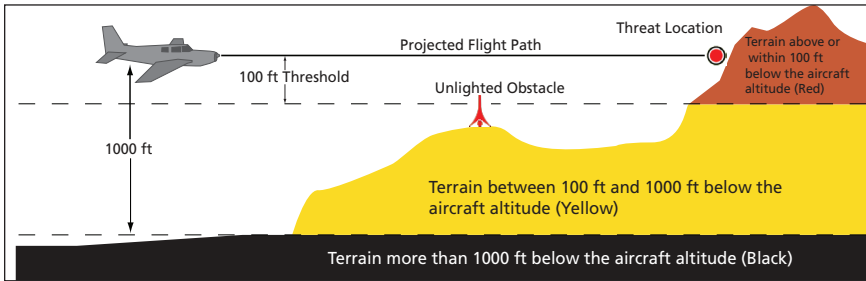

Figure 18-1 Terrain Altitude/Color Correlation

18.5 HTAWS Obstacle Symbols

Foreword

Getting Started

Audio & Xpdr Ctrl

Com/Nav

FPL

Direct-To

Proc

Charts

Wpt Info

Map

Traffic

Terrain

Weather

Nearest

Services/
Music

Utilities

System

Messages

Symbols

Appendix

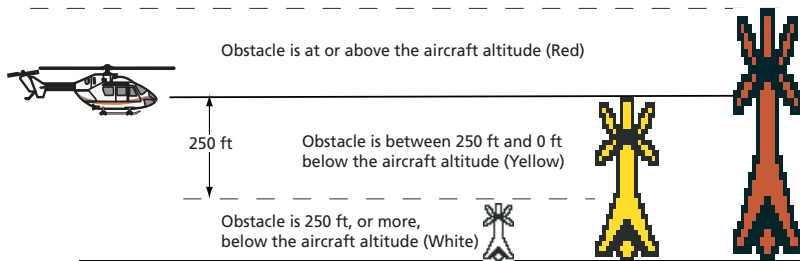

Figure 18-2 HTAWS Obstacle Altitude Correlation

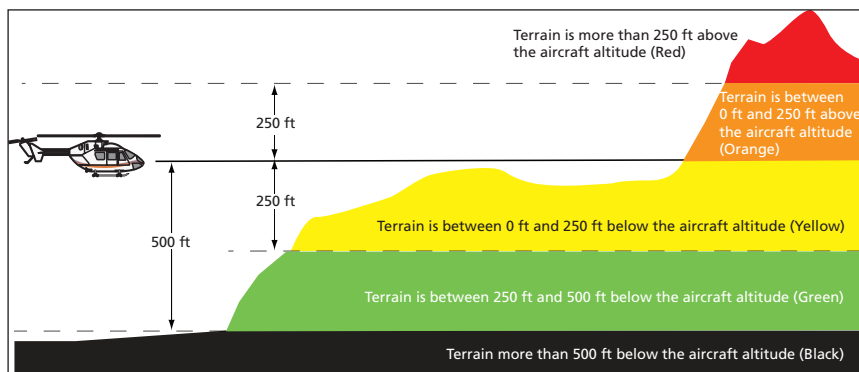

Figure 18-3 HTAWS Altitude/Color Correlation

18.6 Basemap Symbols

Symbol	Description
	Interstate Highway
	State Highway
	US Highway
	National Highway - 2-digit drawn inside
	Small City or Town
	Medium City
	Large City

Table 18-10 Basemap Symbols

Foreword

Getting Started

Audio & Xpdr Ctrl

Com/Nav

FPL

Direct-To

Proc

Charts

Wpt Info

Map

Traffic

Terrain

Weather

Nearest

Services/
Music

Utilities

System

Messages

Symbols

Appendix

18.7 Map Tool Bar Symbols





























Symbol	Description
	Terrain Proximity Enabled and Available Indicator
	Terrain Proximity Enabled and Not Available Indicator
	Point Obstacle Enabled and Available Indicator (Software v5.12 and later)
	Point Obstacle Enabled and Not Available Indicator (Software v5.12 and later)
	Wire Obstacles Enabled and Available Indicator (Software v5.12 and later)
	Wire Obstacles Enabled and Not Available Indicator (Software v5.12 and later)
	StormScope
	Ownship is receiving TIS-B and ADS-R services (Software v5.11 or earlier)
	Possible incomplete traffic picture – ownship is not receiving one (or both) of the TIS-B or ADS-R services (Software v5.11 or earlier)
	Traffic Enabled and Available Indicator
	Traffic Enabled and Not Available Indicator

Table 18-11 Map Tool Bar Symbols

Foreword
Getting Started
Audio & Xpdr Ctrl
Com/Nav
FPL
Direct-To
Proc
Charts
Wpt Info
Map
Traffic
Terrain
Weather
Nearest
Services/
Music
Utilities
System
Messages
Symbols
Appendix

18.8 Miscellaneous Symbols

Symbol	Description
	Low-Wing Prop (Default Ownership)
	High-Wing Prop
	Kit Plane
	Turboprop
	Twin-Engine Prop
	Single-Engine Jet
	Business Jet
	2-Blade Rotorcraft
	3-Blade Rotorcraft
	4-Blade Rotorcraft
	High Visibility Arrow
	Basic Aircraft
	Non-directional ownership is shown if there is no heading or ground track. This typically only occurs during start-up. In helicopters without a heading source, the non-directional ownership symbol will also appear below 15 kts.
	Parallel Track Waypoint
	Restricted/Prohibited/Warning/Alert
	TFR (Temporary Flight Restrictions)
	MOA

Foreword
Getting Started
Audio & Xpdr Ctrl
Com/Nav
FPL
Direct-To
Proc
Charts
Wpt Info
Map
Traffic
Terrain
Weather
Nearest
Services/
Music
Utilities
System
Messages
Symbols
Appendix
Index





Symbol	Description
	Class B Airspace
	Class C Airspace
	Class D Airspace
	User Waypoint

Table 18-12 Miscellaneous Symbols



NOTE: Ownership icons are configured by the installer and can be colored magenta for enhanced visibility (software v5.12 or later).

18.9 Stormscope Symbols





Symbol	Description
	6
	60
	120
	180

Table 18-13 Stormscope Symbols

19 APPENDIX

19.1 Glossary

ACT, ACTV	active, activate
ACT	Altitude Compensated Tilt
ADC	Air Data Computer
ADF	Automatic Direction Finder
ADI	Attitude Direction Indicator
AFM	Airplane Flight Manual
AFMS	Airplane Flight Manual Supplement
AGL	Above Ground Level
AIM	Airman's Information Manual
AIRMET	Airman's Meteorological Information
ALT	altitude
AP	autopilot
APR	approach
APT	airport, aerodrome
ARINC	Aeronautical Radio Incorporated
ARSPC	airspace
ARTCC	Air Route Traffic Control Center
AS	airspeed
ASOS	Automated Surface Observing System
ATC	Air Traffic Control
ATCRBS	ATC Radar Beacon System
ATIS	Automatic Terminal Information Service
AUX	auxiliary
AWOS	Automated Weather Observing System
BARO	barometric setting
BC	backcourse
Bearing	The compass direction from the present position to a destination waypoint
BRG	bearing
C	center runway
°C	degrees Celsius
CDI	Course Deviation Indicator
CHNL	channel

Foreword

Getting Started

Audio & Xpdr Ctrl

Com/Nav

FPL

Direct-To

Proc

Charts

Wpt Info

Map

Traffic

Terrain

Weather

Nearest

Services/ Music

Utilities

System

Messages

Symbols

Appendix

Foreword	CLD	cloud
	CLR	clear
Getting Started	CNXT	Connex
	CONFIG	configuration
Audio & Xpdr Ctrl	Course	The line between two points to be followed by the aircraft
Com/Nav	Crosstrack Error	The distance the aircraft is off a desired course in either direction, left or right
	CRS	course
FPL	CRSR	cursor
	CTA	Control Area
Direct-To	CTAF	Common Traffic Advisory Frequency
	CTRL	control
Proc	CUM	The total of all legs in a flight plan
Charts		
	DALT	density altitude
Wpt Info	DB, DBASE	database
	DCLTR, DECLTR	declutter
Map	deg	degree
	DEP	departure
Traffic	Desired Track (DTK)	The desired course between the active “from” and “to” waypoints
	DEST	destination
Terrain	DFLT	default
	DIS	distance
Weather	Distance	The “great circle” distance from the present position to a destination waypoint
Nearest	DME	Distance Measuring Equipment
	DP	Departure Procedure
Services/ Music	DPRT	departure
	DSBL	disabled
Utilities	DTK	Desired Track
System		
	EDR	Excessive Descent Rate
Messages	EGNOS	Provides SBAS service for most of Europe and parts of North Africa
	ELEV	elevation
Symbols	EMI	Electromagnetic Interference
Appendix	ENR	en route

En Route Safe Altitude

ERR	error	Foreword
ESA	En route Safe Altitude	Getting Started
ETA	Estimated Time of Arrival	Audio & Xpdr Ctrl
ETE	Estimated Time En Route	Com/Nav
°F	degrees Fahrenheit	FPL
FAA	Federal Aviation Administration	
FCC	Federal Communication Commission	Direct-To
FCST	forecast	
FD	flight director	Proc
FIR	Flight Information Region	
FIS-B	Flight Information Services-Broadcast	Charts
FISDL	Flight Information Service Data Link	
FLTA	Forward Looking Terrain Avoidance	Wpt Info
FPL	flight plan	
FREQ	frequency	Map
FRZ	freezing	
FSS	Flight Service Station	Traffic
ft	foot/feet	Terrain
GAGAN	Provides SBAS service for India	Weather
GCS	Ground Clutter Suppression	
GDC	Garmin Air Data Computer	Nearest
GDL	Garmin Satellite Data Link	
GEO	geographic	Services/ Music
GLS	Global Navigation Satellite Landing System	
GMA	Garmin Audio Panel System	Utilities
GMT	Greenwich Mean Time	
GMU	Garmin Magnetometer Unit	
GPS	Global Positioning System	System
GPSS	GPS Roll Steering	
Ground Speed	The velocity that the aircraft is travelling relative to a ground position	Messages
Ground Track	<i>see Track</i>	Symbols
GRS	Garmin Reference System	
GS	Ground Speed	Appendix

Foreword	G/S, GS GTX	glideslope Garmin Transponder
Getting Started		
Audio & Xpdr Ctrl	HDG Heading	heading The direction an aircraft is pointed, based upon indications from a magnetic compass or a properly set directional gyro
Com/Nav		
FPL	HFOM Hg hPa	Horizontal Figure of Merit mercury hectopascal
Direct-To	HPL	Horizontal Protection Level
Proc	HSDB HSI	High-Speed Data Bus Horizontal Situation Indicator
Charts	HTAWS Hz	Helicopter Terrain Awareness and Warning System Hertz
Wpt Info		
Map	IAF ICAO	Initial Approach Fix International Civil Aviation Organization
Traffic	IFR IGRF	Instrument Flight Rules International Geomagnetic Reference Field
Terrain	ILI ILS	Imminent Line Impact Instrument Landing System
Weather	IMC IOI	Instrument Meteorological Conditions Imminent Obstacle Impact
Nearest	INFO in HG	information inches of mercury
Services/ Music	INT INTEG ITI	intersection(s) integrity (RAIM unavailable) Imminent Terrain Impact
Utilities		
System	L LAT	left, left runway latitude
Messages	LCD LCL	Liquid Crystal Display local
Symbols	LED Leg	Light Emitting Diode The portion of a flight plan between two waypoints
Appendix	LIFR LNAV	Low Instrument Flight Rules Lateral Navigation

LOC	localizer	
LOI	loss of integrity (GPS)	Foreword
LON	longitude	
LPV	Localizer Performance with Vertical guidance	Getting Started
LRU	Line Replacement Unit	
LT	left	Audio & Xpdr Ctrl
LTNG	lightning	Com/Nav
MAG	Magnetic	FPL
MAG VAR	Magnetic Variation	
MapMX	A proprietary data format used to forward navigation information between Garmin units	Direct-To
MAX	maximum	Proc
MAXSPD	maximum speed (overspeed)	
MDA	barometric minimum descent altitude	Charts
METAR	Aviation Routine Weather Report	
MGRS	Military Grid Reference System	Wpt Info
MIN	minimum	
Minimum Safe Altitude	Uses Grid MORAs to determine a safe altitude within ten miles of the aircraft present position	Map
MKR	marker beacon	Traffic
MOA	Military Operations Area	
MOT	Mark On Target	
MOV	movement	Terrain
mpm	meters per minute	Weather
MSA	Minimum Safe Altitude	
MSAS	Provides SBAS service for Japan only	Nearest
MSG	message	
MSL	Mean Sea Level	Services/ Music
MT	meter	
mV	millivolt(s)	Utilities
MVFR	Marginal Visual Flight Rules	System
NAV	navigation	
NAVAID	NAVigation AID	Messages
NCR	Negative Climb Rate	
NDB	Non-Directional Beacon	Symbols
NEXRAD	Next Generation Radar	

Foreword	OAT	Outside Air Temperature
	OBS	Omni Bearing Selector
Getting Started		
Audio & Xpdr Ctrl	PA	Proximity Advisory
	PC	personal computer
Com/Nav	PDA	Premature Descent Alert
	P. POS	Present Position
FPL	PTK	parallel track
Direct-To		
	QTY	quantity
Proc		
Charts	R	right, right runway
	RA	Resolution Advisory
Wpt Info	RAIM	Receiver Autonomous Integrity Monitoring
	RAM	random access memory
Map	REF	reference
	REQ	required
Traffic	REV	reverse, revision, revise
	RLC	Reduce Required Line Clearance
Terrain	RMI	Radio Magnetic Indicator
	RNG	range
Weather	RNWW	runway
	ROC	Reduced Required Obstacle Clearance
Nearest	RT	right
	RTC	Reduced Required Terrain Clearance
Services/ Music		
	SAR	Search and Rescue
Utilities	SBAS	Satellite-Based Augmentation System
	SCIT	Storm Cell Identification and Tracking
System	SD	Secure Digital
	SFC	surface
Messages	SIAP	Standard Instrument Approach Procedures
	SID	Standard Instrument Departure
Symbols	SIGMET	Significant Meteorological Information
	SLP/SKD	slip/skid
Appendix	SMBL	symbol
	SPD	speed

SRVC, SVC	service	
STAR	Standard Terminal Arrival Route	Foreword
STATS	statistics	Getting Started
STBY	standby	
STD	standard	Audio & Xpdr Ctrl
SUA	Special Use Airspace	
SUSP	suspend	
SW	software	Com/Nav
SYS	system	FPL
T	true	Direct-To
TA	Traffic Advisory	
TACAN	Tactical Air Navigation System	Proc
TAF	Terminal Aerodrome Forecast	
TAS	True Airspeed	Charts
TAS	Traffic Advisory System	
TAT	Total Air Temperature	Wpt Info
TAWS	Terrain Awareness and Warning System	
TCA	Terminal Control Area	Map
TCAS	Traffic Collision Avoidance System	
TEMP	temperature	Traffic
TERM	terminal	
TFR	Temporary Flight Restriction	Terrain
T HDG	True Heading	
TIS	Traffic Information System	Weather
TMA	Terminal Maneuvering Area	
Topo	topographic	Nearest
Track	Direction of aircraft movement relative to a ground position; also 'Ground Track'	Services/ Music
TRK	track	
TRSA	Terminal Radar Service Area	Utilities
UNAVAIL	unavailable	System
USR	user	
UTC	Coordinated Universal Time	Messages
UTM/UPS	Universal Transverse Mercator/ Universal Stereographic Grid	Polar Symbols

Foreword	V, Vspeed	velocity (airspeed)
	VAR	variation
Getting Started	VFR	Visual Flight Rules
	VHF	Very High Frequency
Audio & Xpdr Ctrl	VLOC	VOR/Localizer Receiver
	VMC	Visual Meteorological Conditions
Com/Nav	VNAV	vertical navigation
	VOR	VHF Omni-directional Range
FPL	VORTAC	very high frequency omnidirectional range station and tactical air navigation
Direct-To	VRP	Visual Reporting Point
	VS	Vertical speed
Proc	VSI	Vertical Speed Indicator
Charts	WAAS	Wide Area Augmentation System
Wpt Info	WGS-84	World Geodetic System - 1984
	WPT	waypoint(s)
Map	WX	weather
Traffic	XPDR	transponder
Terrain	XTK	cross-track
Weather		
Nearest		
Services/ Music		
Utilities		
System		
Messages		
Symbols		

Appendix

19.2 Datacard Information and Updates

The GTN uses several databases to provide up-to-date aviation information. GTN databases can be updated by the pilot using an SD card or Flight Stream 510 wireless database card. The GTN can also synchronize databases in the cockpit with other displays using Database SYNC and Chart Streaming.

Information about the installed and standby databases can be viewed on the System Status page. Database SYNC and Chart Streaming can be configured in the menu on the System Status page.

The database card should not be removed except to update the databases stored on the card. For basic flight operations a database card is required for database storage. The database cards cannot be shared between units.

19.2.1 GTN Databases

- **Navigation** - The navigation database contains information for waypoints and airports, such as procedures, runways, airways, airspaces, frequencies, and visual reporting points. For helicopter applications, a navigation database that includes additional heliports is available.
- **Basemap** - The basemap database contains land and water data, such as roads, boundaries, rivers, and lakes.
- **SafeTaxi** - The SafeTaxi database contains detailed airport diagrams for selected airports. These diagrams aid in following ground control instructions by displaying the aircraft position on the map in relation to taxiways, ramps, runways, terminals, and services.
- **Obstacles** - The obstacle database contains data for obstacles, such as towers, that pose a potential hazard to aircraft. Obstacles 200 feet and higher are included in the fixed-wing obstacle database. The rotorcraft database includes all reported obstacles regardless of height. It is important to note that not all obstacles are necessarily charted and therefore may not be contained in the obstacle database. Several obstacle database options are available. Obstacle databases created for GTN software v5.10 or later include all power lines or only Hazardous Obstacle Transmission (HOT) lines depending on the type of obstacle database installed. HOT lines are those power lines that are co-located with other FAA-identified obstacles. The obstacle database is required for the TAWS and HTAWS functions.

Foreword

Getting Started

Audio & Xpdr Ctrl

Com/Nav

FPL

Direct-To

Proc

Charts

Wpt Info

Map

Traffic

Terrain

Weather

Nearest

Services/ Music

Utilities

System

Messages

Symbols

Appendix

Foreword
Getting Started
Audio & Xpdr Ctrl
Com/Nav
FPL
Direct-To
Proc
Charts
Wpt Info
Map
Traffic
Terrain
Weather
Nearest
Services/ Music
Utilities
System
Messages
Symbols
Appendix

- **Terrain** - The terrain database contains terrain mapping data. The terrain database is required for the TAWS and HTAWS functions. Systems using HTAWS require a 2.5 arc-second database while non-HTAWS applications can use a 9 arc-second database.
- **FliteCharts** - FliteCharts resemble the paper version of AeroNav Services (formerly named National Aeronautical Charting Office) terminal procedure charts. The charts are displayed with high-resolution and in color for applicable charts. The GTN depiction shows the aircraft position on the moving map in the plan view of the approach charts and on airport diagrams.
- **ChartView** - ChartView resembles the paper version of Jeppesen terminal procedure charts. The charts are displayed in full color with high-resolution. The GTN depiction shows the aircraft position on the moving map in the plan view of approach charts and on airport diagrams.

Database Name	Where Stored	Update Cycle	Provider	Notes
Navigation	Internal memory	28 days	flyGarmin.com	
Basemap	Internal memory	As required	flyGarmin.com	
SafeTaxi	Internal memory	56 days	flyGarmin.com	
Obstacle	Internal memory	56 days	flyGarmin.com	
Terrain	Database card	As required	flyGarmin.com	
FliteCharts	Database card	28 days	flyGarmin.com	Disables 180 days after expiration date.
Chartview	Database card	14 days	Contact Jeppesen	Disables 70 days after expiration date.

Table 19-1 Database List



NOTE: Garmin requests that the flight crew report any observed discrepancies related to database information. These discrepancies could come in the form of an incorrect procedure, incorrectly identified terrain, obstacles and fixes, or any other displayed item used for navigation or communication in the air or on the ground. To report an aviation database error, visit flyGarmin.com.

19.2.2 Updating Databases with an SD Card

To update the GTN database use an SD card. Instructions on updating the GTN database and the required equipment is found at flyGarmin.com.

The ChartView database is provided directly from Jeppesen. Contact Jeppesen (jeppesen.com) for ChartView subscription and update information. An enablement card that is purchased from Garmin is separate from the Jeppesen database and is required to enable ChartView.

1. Download the database updates to the Garmin Database Card from the appropriate website.
2. Insert the database card into the slot of the GTN.
3. Apply power to the GTN.
4. The database update page will be displayed, listing all effective database updates on the database card. Database cycles that are not effective or already installed will be kept on the Garmin Database Card as standby databases until they become effective. Hold down the dual-concentric knob while applying power to the GTN to force the update of these databases.

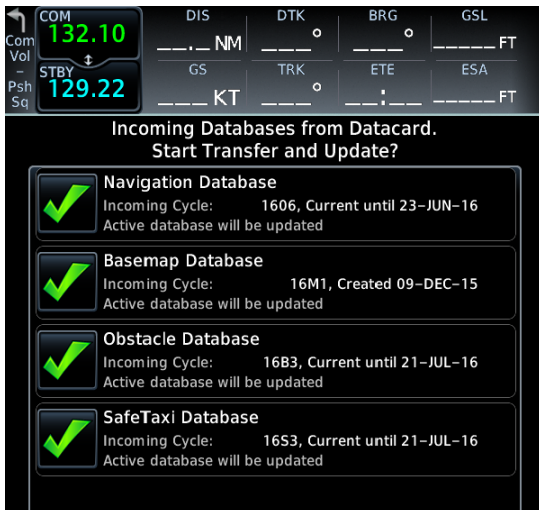

Figure 19-1 Updated Databases

Foreword

Getting Started

Audio & Xpdr Ctrl

Com/Nav

FPL

Direct-To

Proc

Charts

Wpt Info

Map

Traffic

Terrain

Weather

Nearest

Services/ Music

Utilities

System

Messages

Symbols

Appendix



5. Select the desired database updates and touch the **Update** key.



NOTE: Do not remove power to the GTN while updating databases.

6. The GTN will begin the update process and then verify the integrity of the installed databases.

7. Check that all databases are current and there are no errors. If a database is highlighted in yellow, it is either expired or missing.

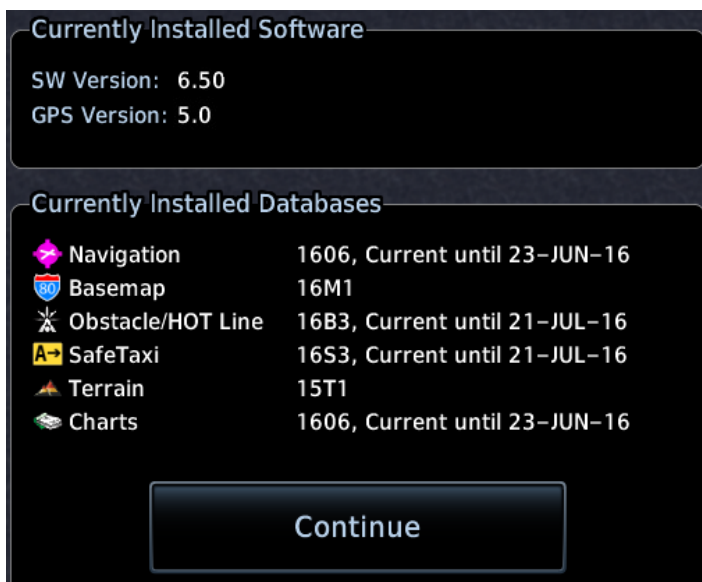

Figure 19-2 Currently Installed Software/Databases

19.2.3 Updating Databases with a Flight Stream 510

GTN databases can also be updated using the Flight Stream 510 wireless database card with a portable device and the Garmin Pilot application.

1. Follow the instructions within the app to purchase and download the database updates.
2. Ensure the Flight Stream 510 is inserted into the database card slot and apply power to the GTN.
3. When prompted on the database verification screen, connect the portable device to the Flight Stream 510 Wi-Fi network. The network name and password can be displayed by pressing the **Show WiFi Info** key.

Show
WiFi
Info

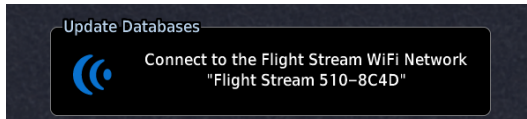

Figure 19-3 Connect to Flight Stream Wi-Fi Network Prompt

4. Once Connected, open Garmin Pilot on the portable device.

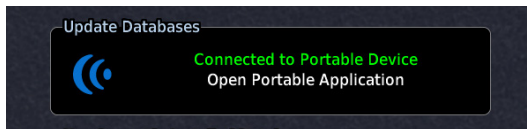

Figure 19-4 Open Portable Application Prompt

5. The Flight Stream 510 checks for database updates on the portable device and displays the database update page or notifies the pilot that no database updates are available.

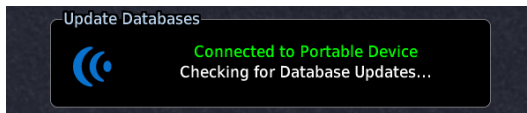

Figure 19-5 Checking for Database Updates Message

Foreword

Getting Started

Audio & Xpdr Ctrl

Com/Nav

FPL

Direct-To

Proc

Charts

Wpt Info

Map

Traffic

Terrain

Weather

Nearest

Services/ Music

Utilities

System

Messages

Symbols

Appendix



Figure 19-6 Database Update Page

6. Select the desired database updates. All selected databases will be transferred to the GTN, but the GTN may choose to not install all databases. Database cycles that are not yet effective will be preloaded and kept as standby databases until they become effective. Databases that are not supported by this GTN may be transferred and then SYNC'd to other Garmin displays.
7. Touch the **Update** key.



NOTE: Do not remove power to the GTN while updating databases.

8. The GTN will begin the transfer, update, and verification process. The terrain and charts databases can take up to 5 minutes each to transfer over Wi-Fi to the Flight Stream 510.
9. Check that all databases are current and there are no errors. If a database is highlighted in yellow, it is either expired or missing.

19.2.4 Database SYNC

Database SYNC allows the GTN to synchronize databases from a single unit to other Garmin avionics. The pilot only needs to update a single database card (SD card or Flight Stream 510) and the new databases are automatically SYNC'd through the units connected in the cockpit and configured for Database SYNC. Databases must be purchased for all avionics in the cockpit.

Database SYNC is supported by these database types:

- Navigation
- Basemap
- SafeTaxi
- Obstacle
- FliteCharts
- Airport Directory

The database SYNC process may take several minutes, depending on how many databases have been updated. The status of the database transfers to a unit can be viewed on the System Status page under the "Standby" tab. The GTN will display the source of the received databases (for example: "Database SYNC - GTN #2"). If a database SYNC is pending, completed, or not authorized, the status will also be indicated.

When the SYNC is complete, if the aircraft is stopped and has yet to takeoff, the pilot will be prompted with the option to restart and update to the newly transferred database.



NOTE: *Restarting the GTN must only be performed when the aircraft is on the ground as navigation and communication from the restarted unit will be lost for a period of time.*

Foreword

Getting Started

Audio & Xpdr Ctrl

Com/Nav

FPL

Direct-To

Proc

Charts

Wpt Info

Map

Traffic

Terrain

Weather

Nearest

Services/ Music

Utilities

System

Messages

Symbols

Appendix

19.2.4.1 Resolving Database SYNC Conflicts

Database conflicts must be resolved for synchronization to occur. Conflicts exist when multiple LRUs have a database of the same cycle, but with different regions or types (e.g., fixed wing vs. rotorcraft navigation database, different regions of the navigation database, or different obstacle database types). The GTN attempts to resolve these by automatically synchronizing the most recently installed database across all other LRUs (software v6.30 and later). Pilot intervention is required when conflicts cannot be resolved automatically. Conflicts occurring with earlier software versions also require manual intervention.

To manually resolve database conflicts, touch the **Resolve Conflicts** key on the display containing the desired database version. This key is located on the Conflicts tab of the System Information page.

19.2.5 Chart Streaming

While the Chart database is SYNCing in the background, the GTN will stream individual charts to other compatible displays. This enables all Garmin displays to use the latest chart database information even though the database is currently installed only on a single unit. Chart Streaming will begin after the chart database has begun SYNCing.

- Foreword
- Getting Started
- Audio & Xpdr Ctrl
- Com/Nav
- FPL
- Direct-To
- Proc
- Charts
- Wpt Info
- Map
- Traffic
- Terrain
- Weather
- Nearest
- Services/ Music
- Utilities
- System
- Messages
- Symbols
- Appendix
- Index

19.2.6 Database Troubleshooting Tips

Problem	Action
Unable to download databases to the SD card	<ul style="list-style-type: none"> • Ensure you have a high capacity SD card programmer • Ensure that your card programmer is plugged directly into your computer and not into a USB hub, computer screen, or keyboard • Ensure the sliding lock tab is in the unlocked position (up, when viewing the card label-side up)
Database update fails	<ul style="list-style-type: none"> • Restart the GTN and retry the update • Download the databases to the database card again • Ensure that the databases were purchased for the system ID of the GTN that the database card is being used to update
Database SYNC fails	<ul style="list-style-type: none"> • Ensure that the databases were purchased for all the GTNs and GDUs in the cockpit • Ensure that all conflicts have been resolved (19.2.4.1)
Database cannot be selected for update	<ul style="list-style-type: none"> • Restart the GTN while pressing the dual-concentric knob until the Garmin logo is fully illuminated to view all database updates on the database card, regardless of effectivity • Download the databases to the database card again • Ensure that the databases were purchased for the system ID of the GTN that the database card is being used to update
Database cannot be transferred to Flight Stream 510	<ul style="list-style-type: none"> • Ensure that the databases were purchased for the system ID of the GTN that the database card is being used to update • Ensure that the database transfers are enabled for the Flight Stream 510 (19.2.3) • Ensure that all database updates have been downloaded to the Garmin Pilot application • Press the Show All DBs key on the database verification page to view all database updates on the portable device, regardless of effectivity
Database is transferred to Flight Stream 510 but cannot be selected for update	<ul style="list-style-type: none"> • Ensure that the databases were purchased for the system ID of the GTN that the database card is being used to update • Ensure that the transferred database is currently effective • Restart the GTN while pressing the dual-concentric knob until the Garmin logo is fully illuminated to view all database updates on the Flight Stream 510, regardless of effectivity

Table 19-2 Database Troubleshooting Tips

Foreword

Getting Started

Audio & Xpdr Ctrl

Com/Nav

FPL

Direct-To

Proc

Charts

Wpt Info

Map

Traffic

Terrain

Weather

Nearest

Services/ Music

Utilities

System

Messages

Symbols

Appendix

19.3 Demo Mode

The GTN product contains a “Demo” mode that allows simulation of all operations of the product to allow practice and familiarization while staying on the ground.



WARNING: Do not use the GTN to navigate while Demo mode is active. Do not use or enter Demo mode while airborne.



1. Press in and hold the **Direct-To** key and then apply power to the unit.

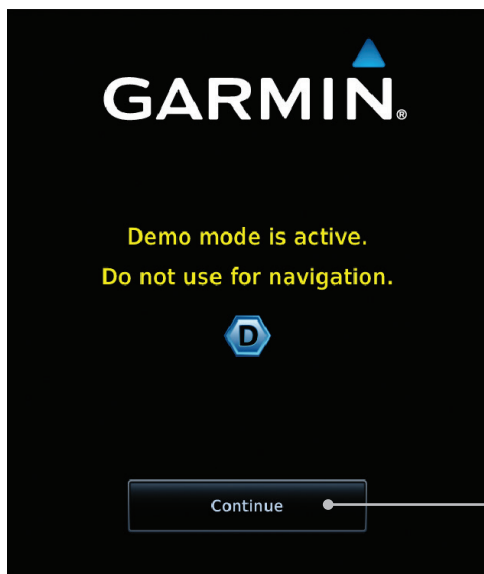

Figure 19-7 Demo Mode Start Up Display



2. Touch the **Continue** key and Fuel keys as normally needed to start operations.



3. Touch the **Demo** key in the lower part of the display to reach the Demo Setup functions.

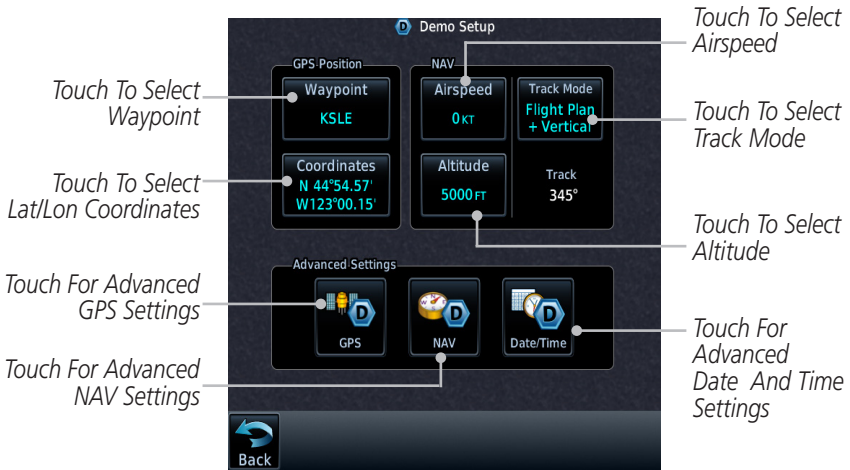

Figure 19-8 Demo Mode Setup



4. Touch the **GPS** key to reach the Demo GPS Settings page. The Position Error values (Horizontal Protection Level Fault Detection [HPL FD], HPL SBAS, and Vertical Protection Level [VPL] SBAS) may be adjusted to reflect errors induced by naturally occurring conditions, but are normally not adjusted for most Demo mode operations.

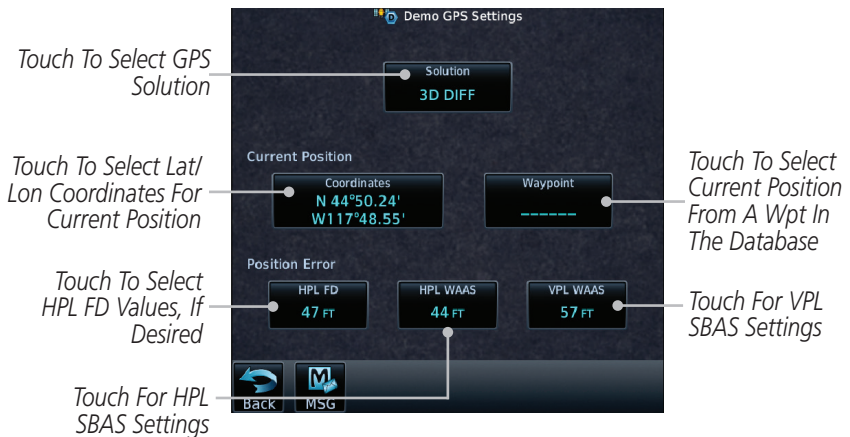

Figure 19-9 Demo Mode GPS Settings

Foreword
Getting Started
Audio & Xpdr Ctrl
Com/Nav
FPL
Direct-To
Proc
Charts
Wpt Info
Map
Traffic
Terrain
Weather
Nearest
Services/Music
Utilities
System
Messages
Symbols
Appendix
Index



5. Touch the **Nav** key to reach the Demo Navigation Settings page.

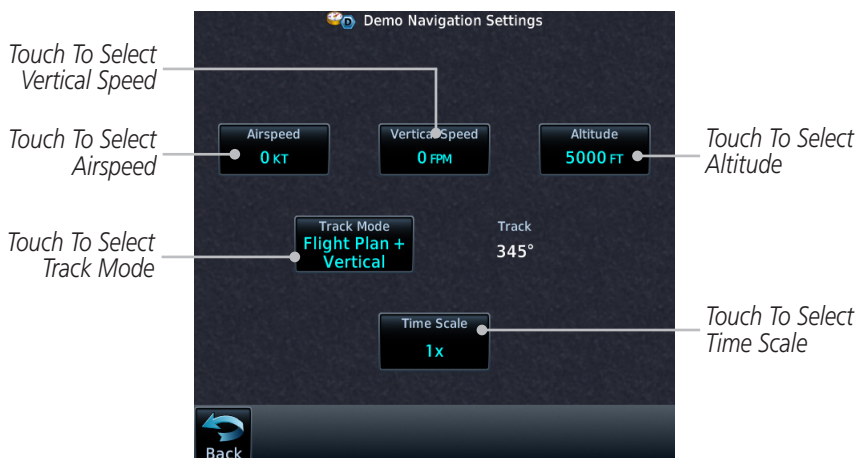

Figure 19-10 Demo Mode Navigation Settings



6. Touch the **Date/Time** key to reach the Demo Date/Time Settings page.

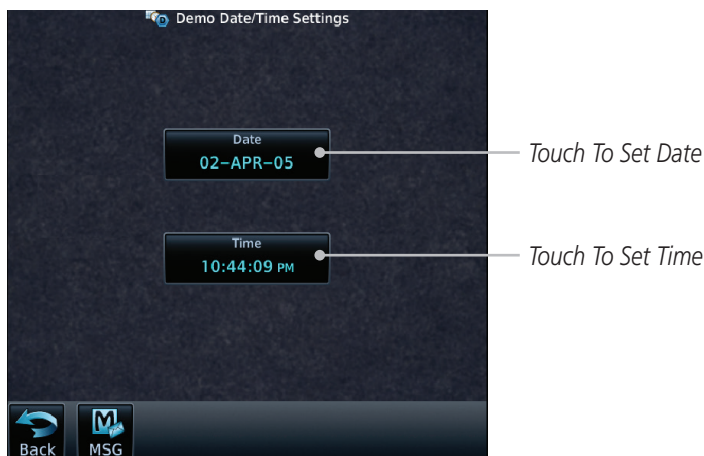

Figure 19-11 Demo Mode Date/Time Settings



7. After completing the settings for Demo mode, touch the **HOME** key or **Back** key to get started with operating the GTN.

19.4 Glove Qualification Procedure



NOTE: *This procedure is not authorized for completion during flight. Perform all tasks while the aircraft is on the ground.*

The touchscreen uses capacitive touch technology to sense the proximity of skin to the display. A glove creates a barrier between the skin and the display glass, potentially reducing the ability of the display to detect touches.

This procedure qualifies a specific glove for use with the touchscreen. Due to differences in finger size, glove size, and touchscreen between the GTN 6XX and GTN 7XX units, the qualification procedure is specific to the pilot/glove and GTN combination. Multiple units must be evaluated individually.

Glove Selection Considerations

- Thinner gloves perform better than thicker gloves
- Leather gloves, and gloves designed specifically for use with capacitive touchscreen devices, are often found to be acceptable
- To improve touchscreen sensitivity while wearing gloves, use the pad of your finger instead of the tip during touch interactions

Glove Qualification Guidance

- Table 19-3 contains the tasks required to qualify a glove
- Table 19-4 contains tasks that are not required to qualify a glove, but may limit how some functions are accessed while wearing a glove

Foreword

Getting Started

Audio & Xpdr Ctrl

Com/Nav

FPL

Direct-To

Proc

Charts

Wpt Info

Map

Traffic

Terrain

Weather

Nearest

Services/ Music

Utilities

System

Messages

Symbols

Appendix

Glove Qualification Steps

Complete only the tasks for the capabilities relevant to the installed GTN(s).

1. Sit in the pilot's seat.
2. Start the GTN in demo mode by pressing and holding the **Direct To** key during power up.
3. Perform the tasks listed in Table 19-3 and Table 19-4, tapping each key with a non-gloved finger. It is not necessary to record any results for this step.
4. Repeat step 3 using a gloved hand.
5. For each task, determine whether the touchscreen response is the same or worse than without the glove.
6. Record the results in the applicable table. Items that may cause the operation to be worse include, but are not limited to:
 - a. Multiple attempts to select a key
 - b. Unintentional selection of adjacent key(s)
 - c. Excessive force on the touchscreen to select a key
7. If all applicable tasks produce the same response with and without a glove, the pilot may use the glove in flight.

Glove Qualification Procedure

Pilot: _____

Glove Description: _____

Circle the applicable GTN.

6XX 7XX

Task	Operation With Glove (circle one)	
Starting from the Home page:		
Demo	Same	Worse
GPS	Same	Worse
Waypoint	Same	Worse
Type the airport identifier "KSLE."	Same	Worse
Enter	Same	Worse
Return to the Home page.		

Task	Operation With Glove (circle one)	
Flight Plan	Same	Worse
Add Waypoint	Same	Worse
Type the airport identifier "KSLE."	Same	Worse
Enter	Same	Worse
Add each of the following waypoints in the same manner.		
KMMV	Same	Worse
KONP	Same	Worse
BTG	Same	Worse
Select BTG .	Same	Worse
Load Airway	Same	Worse
V23	Same	Worse
ALFOR	Same	Worse
Load	Same	Worse
Scroll the list of flight plan waypoints up and down using the arrow keys.	Same	Worse
Back	Same	Worse
GTN 635/650/750 only		
Select the COM STBY frequency field.	Same	Worse
Type a valid frequency.	Same	Worse
Enter	Same	Worse
Select the active COM frequency field. Observe the two frequency values swap positions.	Same	Worse
GTN 750 only		
Select the active NAV frequency field. Observe the two frequency values swap positions.	Same	Worse
GTN 650 only		
Menu	Same	Worse

Table 19-3 Tests Required for Glove Qualification

Foreword

Getting Started

Audio & Xpdr Ctrl

Com/Nav

FPL

Direct-To

Proc

Charts

Wpt Info

Map

Traffic

Terrain

Weather

Nearest

Services/ Music

Utilities

System

Messages

Symbols

Appendix

	Task	Operation With Glove (circle one)	
	Open the Active Flight Plan page.	Same	Worse
	With one finger on the page, drag the waypoint list up and down.	Same	Worse
	With one finger, tap and swipe the list up or down.	Same	Worse
	Back	Same	Worse
	Open the Map page.	Same	Worse
	Graphically Edit FPL	Same	Worse
	Tap and drag KONP to an empty area of the map, panning and zooming as necessary. Observe that KONP is removed from the flight plan.	Same	Worse
	Drag the leg between KMMV and BTG to KSPB. Observe that KSPB is added to the flight plan.	Same	Worse

Table 19-4 Tests Not Required for Glove Qualification

19.5 Telligence Voice Command Qualification Procedure

In order to enable voice command functionality crew members must successfully perform and complete 17/20 (85%) voice commands in the Telligence aircraft qualification procedure. Crew members must be comfortable speaking into an aviation headset and proficient in English.

Voice Command Guidelines



NOTE: *If a voice command is uninterpretable, verify the system is performing the intended action or displaying the desired data. If the system does not recognize a command, use the touchscreen to execute the function. The GTN Voice Command History details all commands performed.*

- Position the headset MIC approximately 1/8-inch from mouth, align with bottom lip to avoid breath sounds in the microphone.
- Speak conversationally.
- Enunciate.
- Speak in a normal tone and volume.
- Speak at a normal cadence (not too quickly or slowly).
- Pause briefly between activation of the PTC switch and when speaking the voice command.
- Review the commands prior to performing the qualification.

Voice Command Instructions

1. Press and hold the Push to Command (PTC) switch.
2. Speak the entire command into the headset MIC.
3. Release the "PTC" switch.
 - A positive tone (low-to-high) indicates the command has been recognized and executed. (i.e., page changed, radio tuned, MIC selected, etc.)
 - A negative tone (high-to-low) indicates the command is either unrecognizable or invalid.

Successful Command Example

“Show approaches page” is spoken, the approach selection page displays immediately, and a positive tone sounds.

Unsuccessful Command Examples

“Show map page” is spoken and the traffic page displays.

"Show map page" is spoken and a negative tone sounds.

Qualification Procedure

Speak the unbold phrase if the voice command in this procedure is not applicable to the aircraft's configuration. If the total number of successful commands is less than 17, the voice commands must be disabled. For instructions on how to activate and deactivate voice commands, refer to 16.13.

Example: If the requirement states a COM radio is required, but your GTN does not have a COM radio, use the unbold command.

1. Start the GTN and acquire a GPS position.
2. Conduct the voice commands in sequential order while wearing an aviation headset. If necessary, a command can be attempted twice.
3. When the command is successful check the box next to the command.

- Foreword
- Getting Started
- Audio & Xpdr Ctrl
- Com/Nav
- FPL
- Direct-To
- Proc
- Charts
- Wpt Info
- Map
- Traffic
- Terrain
- Weather
- Nearest
- Services/ Music
- Utilities
- System
- Messages
- Symbols

SHOW Flight Plan PAGE

*** Manually enter a flight plan with a towered airport as the destination ***

SHOW Trip Planning PAGE

* **TUNE Nearest Ground** or SHOW Nearest Airport PAGE

* **TUNE Nearest ATIS** or SHOW Nearest Weather Frequency PAGE

† **TOGGLE COM 2** or SAY Distance

SHOW Map PAGE

ZOOM OUT

SAY Distance to Destination

SHOW Flight Timers PAGE

† **SELECT COM 2** or SAY ETA at Destination

SAY Active Waypoint

CREATE Waypoint Here

* **TUNE Destination Tower** or SHOW Destination Runways PAGE

‡ **SHOW Traffic PAGE** or SHOW Nearest PAGE

SHOW Procedures PAGE

SHOW V-CALC PAGE

SHOW Current Time

SAY Desired Track

BACK

SHOW Voice Command History Page

* A GTN COM radio is required.

† Two COM radios connected to the GMA are required.

‡ Traffic capability is required on the GTN.

Foreword

Getting Started

Audio & Xpdr Ctrl

Com/Nav

FPL

Direct-To

Proc

Charts

Wpt Info

Map

Traffic

Terrain

Weather

Nearest

Services/ Music

Utilities

System

Messages

Symbols

Appendix

Foreword

Getting Started

Audio & Xpdr Ctrl

Com/Nav

FPL

Direct-To

Proc

Charts

Wpt Info

Map

Traffic

Terrain

Weather

Nearest

Services/
Music

Utilities

System

Messages

Symbols

Appendix

Index

This page intentionally left blank

INDEX

Symbols

3D Audio 2-12

3D navigation 16-7

A

About this guide xxvii

Above Ground Level 11-11, 11-22

Acquiring satellites 16-5, 16-7

ACT 12-54

Activate flight plan 4-44

Activate leg 4-6

Activating XM 14-3

Active flight plan page 4-4

Active leg 4-6, 6-15, 6-17, 6-26

Add User frequency 3-11

ADF 19-1

ADIZ 9-40

ADS-B 2-5, 10-17

Age 12-7, 12-63

Aircraft symbol 9-1

AIREP 12-28

AIRMETs 12-17, 12-70, 12-85

Airport beacon 18-2

Airport diagram 7-16

Airport frequencies 8-8

Airports 12-84

Airspace 13-12

Airspace altitude buffer 16-29

Airways 4-15, 9-6, 9-40

Alerts 1-13, 10-9, 11-6, 11-15, 11-16,

11-19, 11-26, 11-27, 11-29,

11-33, 11-61, 16-28

ALT 15-29

Altimeter ii

Altitude 6-15, 11-6, 16-4, 16-6

Altitude buffer 16-28

Altitude Display Mode 10-6, 10-15

Altitude mode 10-26

Altitude reporting 2-3

Altitude type 15-6

Angle of incidence 12-37

Annunciations 1-6, 1-21, 6-2, 10-10,
10-11, 10-16, 11-10, 11-15,
11-20, 11-21, 11-26, 11-33,
11-72

Anonymous mode 2-5

Answering a phone call 14-14

Antenna 12-78

Antenna stabilization 12-54

Antenna tilt 12-34, 12-35, 12-39, 12-49,
12-52, 12-53

Approach

Channel 6-12

Approaches 7-2, 7-16, 11-17, 11-30,
11-63, 19-1

Select 1-20

Approach operations 6-2

Approach shield 10-32

Approach with hold 6-15

Arc 11-8, 11-13, 11-14, 11-24, 11-25

Arrivals 7-16

ARTCC 13-1, 13-15

ASOS 13-19

ATCRBS 10-7

ATIS 13-19

Attitude 19-1

Audio panel 2-9

Audio split mode 2-16

Aural message 11-11, 11-15, 11-16,
11-20, 11-22, 11-26, 11-28,
11-31, 11-33, 11-68

Automatic CDI switching 6-27

Autopilot 6-14, 6-19, 6-26, 6-27, 6-29

Auto-pilot output 6-29

Auto squelch 2-21

Auto zoom 9-17

AUX - System Status Page 16-3

Aviation map data 9-27

AWOS 13-19

B

Backcourse 6-27

Backlighting 16-41

Baro-corrected altitude 6-1

Barometric pressure 15-29

Foreword

Getting Started

Audio & Xpdr Ctr

Com/Nav

FPL

Direct-To

Proc

Charts

Wpt Info

Map

Traffic

Terrain

Weather

Nearest

Services Music

Utilities

System

Messages

Symbols

Appendix

- Foreword Basemap symbols 18-7
- Getting Started Basic approach operation 6-2
- Audio & Xpdr Ctrl Beacon 18-2
- Com/Nav Blind Alley 12-42
- FPL **C**
- Direct-To Calibrated gain 12-51
- Proc Call suppression 14-15
- Charts Catalog 4-2
- Wpt Info Category 14-5
- Map Cautions iii, 9-40, 11-11, 11-12, 11-16, 11-22, 11-23, 11-27, 11-52, 11-53, 12-45, 12-47
- Traffic CDI 9-50
- Terrain Ceiling 13-14
- Weather Cell movement 12-16
- Nearest Channel 14-2, 14-5, 14-8
- Services/Music Chart spacing 1-12
- Utilities Chart airport info 7-9
- System Chart airport selection 7-4
- Messages Chart Color Scheme 9-26
- Symbols Chart detail
- Appendix Approaches 7-6
- Index Arrivals 7-8
- Class B airspace 9-40, 18-10
- Class C airspace 9-40, 18-10
- Class D airspace 9-40, 18-10
- Clean screen 15-34
- Clearance recorder 2-17
- Cloud tops 12-15
- Com 1-17, 3-1
 - Channel spacing 1-12, 16-20
 - Frequency monitoring 3-15
 - Tuning 3-3
 - Window 3-3
- Connex 4-52, 16-42
- Connex weather 12-56
- Contacts 14-21
- Controlled airspace 9-52, 13-12
- Controls 1-4
- Conventions xxviii, 1-2
- Copy flight plan 4-46
- Corrective Resolution Advisory 10-43, 10-44
- County warnings 12-18
- Creating a flight plan 1-19, 4-2
- Creating user waypoints 8-19, 9-44
- Crossfill 1-12, 1-15, 16-24
- CTAF 8-8
- Customer service 14-3
- Customizing maps 9-14
- Cycle number 1-6, 7-16, 7-19
- Cyclone 12-21
- D**
- Database 1-4, 1-6, 3-5, 3-18, 7-16, 7-19, 11-1, 11-6, 11-19, 11-33, 12-66, 16-3, 16-4, 19-9, 19-11, 19-15, 19-16, 19-17
- Database SYNC 16-4
- Database update with Flight Stream 510 19-13
- Database verification 1-7
- Data link 10-3, 12-63
- Data Link Receiver troubleshooting 14-9
- Data request 12-59
- Data user field 16-31
- Date 7-15, 7-16, 7-19, 15-12, 15-13, 16-18
- Date/Time 19-20
- Dead reckoning 1-21

- Declutter 9-33
- Delete flight plan 4-47
- Demo mode 19-18
- Density altitude 15-29
- Departures 6-3, 7-16, 11-17, 11-30, 11-63
- Departure time 15-11
- Destination proximity 16-29
- Direct-To 1-5, 1-16, 5-1
- Direct-To Fpl Wpt 5-3
- Direct-To Nrst Airport 5-5
- Distance 9-17
- DME Arc 6-16
- Don't sink 11-28, 11-31, 11-68
- DP 7-16
- Dual installation 1-15
- E**
- Echo tops 12-14
- Edit flight plan 4-45, 9-45
- Edit FPL data fields 4-41
- EGNOS 16-8
- Emergency frequency 3-13
- Enablement card 7-2, 7-15
- ENR 6-3
- EPU 16-5, 16-7
- European airways 9-31
- Excessive Closure Rate 11-64
- Excessive descent rate alert 11-28, 11-29, 11-61
- Exposure level 12-38
- Extended squitter 2-7
- External LRU 16-11
- F**
- Facility name 13-15, 13-17, 13-19
- Failed text message 14-18
- FastFind 1-22
- FDE 16-7
- Field elevation 10-28
- Find Com frequency 3-5
- FIR 13-1
- FIS-B 12-71
- Five-hundred aural alert 11-17, 11-28
- Flap Override 11-67
- Flight ID 2-5
- Flight Into Terrain 11-66
- Flight phase 11-17, 11-30, 11-63
- Flight plan 1-19, 4-1, 9-17, 15-20, 15-27
- Flight plan frequency 3-9
- Flight plan import 4-56, 16-43
- Flight plan menu 4-28
- Flight Stream 4-52
- Flight Stream 510
 - Using to update database 19-13
- Flight timers 15-11
- FliteCharts 7-16
- FliteCharts database 7-16
- Fog 12-36
- Forward looking terrain avoidance 11-17, 11-29, 11-44, 11-62
- Freezing level 12-19, 12-24, 12-49
- Frequency
 - Flight plan 3-9
 - Monitoring 3-15
 - Nearest 3-6
 - New user 3-11
 - Recent 3-6
- Frequency finding 3-5, 3-18
- FSS 13-1, 13-17
- Fuel planning 15-23
- Fuel settings 1-7, 16-33
- Function user field 16-32
- G**
- GAGAN 16-8
- GBT 12-64, 12-72
- GDC 74A ii
- GDL 69/69A 14-2, 14-3, 14-9, 16-11
- GDL 69/69A status 16-11
- GDL 69 troubleshooting 14-9
- GDL 88 2-5, 16-13
- Geo-reference 7-14
- Getting started 1-1
- Glideslope 3-16
- Glossary 19-1
- Glove qualification procedure 19-21
- GMT 16-18
- GPS 19-19
- Foreword
- Getting Started
- Audio & Xpdr Ctr
- Com/Nav
- FPL
- Direct-To
- Proc
- Charts
- Wpt Info
- Map
- Traffic
- Terrain
- Weather
- Nearest
- Services Music
- Utilities
- System
- Messages
- Symbols
- Appendix

Foreword	GPS altitude ii, 11-6
	GPS status 16-4
Getting Started	Graphically editing flight plan 4-52, 5-9, 9-45
Audio & Xpdr Ctrl	Graphical Weather 12-71
	Ground 2-3
	Ground Clutter Suppression 12-54
Com/Nav	Ground return 12-37, 12-39, 12-53
	Ground speed 11-20, 11-33, 11-72
FPL	GSL 11-6
	GSR 56 12-56, 14-1, 14-11, 14-20, 16-14
Direct-To	GTN 725 1-1
	GTN 750 1-2
Proc	GTX 2-1, 2-3, 2-7, 9-8, 10-3, 10-24, 10-25, 12-71, 16-13, 16-43, 16-45
Charts	GWX Radar 12-45
	H
Wpt Info	Hail 12-10, 12-11, 12-36, 12-41, 12-44
	HDOP 16-5
Map	Heading 10-5, 10-14, 11-13, 11-24
Traffic	Helipad 8-10, 8-11, 18-2
	HFOM 16-5, 16-7
	Hold 6-15
Terrain	Home page 1-5
	Horizontal scan 12-33, 12-52, 12-55
Weather	Hot spots 7-17, 7-18
	HSI 9-50
Nearest	HSI annunciation 6-19
	HTAWS 11-34, 18-6
	I
Services/ Music	Icing 12-26, 12-70
Utilities	Ident 2-2, 3-16
	IFR 1-20, 12-20, 12-67, 12-70, 12-84
System	ILS Approach 2-14, 6-18
	ILS CDI Selection 6-27
Messages	Imminent Line Impact 11-17, 11-29, 11-62
	Imminent obstacle impact 11-17, 11-29, 11-57, 11-58, 11-62
Symbols	Imminent terrain impact 11-17, 11-29, 11-62
Appendix	Import user waypoints 8-24
Index	Index-4

Infrared 12-66
Insert after 4-9
Insert before 4-7
Intercom 2-18
Intersection 8-12, 9-27, 9-40, 13-4
Invert colors 7-14
Invert flight plan 4-30, 4-44
Iridium 12-56, 14-1, 14-11, 14-19

J

Jeppesen 19-9
Jeppesen database 19-9

K

King autopilot 6-29
Knobs 1-2, 1-5

L

Land data 9-5, 9-28
Legend 12-5, 12-69
Level 11-16, 11-17, 11-27, 11-30, 11-63, 12-41
Lighting 16-41
Lightning 9-40, 12-22, 12-65, 12-66
Limitations 10-7, 11-10, 11-21, 12-11
LNAV 6-3, 6-19
LNAV+V 6-3, 6-19
LNAV/VNAV Approach 6-3
Load procedures in FPL 4-13
Localizer 3-16, 6-27
Local offset 16-18
Lock activation 16-12
Locking screw 1-3
Low alt 6-3
LP +V 6-3, 6-19, 6-21
LP approach 6-3, 6-19
LPV Approach 6-3, 6-19
L/VNAV 6-19

M

Magnetic variation 16-33, 16-34
Making a phone call 14-12
Manual mag var 16-34
Map 9-1
Symbols 9-52
Map controls 9-44

Map Detail 9-39
 Map menu 9-3
 Map orientation 9-16, 12-60
 Map overlay 9-4
 Map panning 9-41
 MAPR 6-3
 Map range 7-17, 9-16, 10-15, 11-13, 11-24
 Map setup 9-13
 Map symbols 18-1, 18-7
 Map toolbar symbols 18-8
 Marker beacon 2-14
 Marker Hi Sense 2-15
 Mark on target 8-20
 Mean Sea Level 11-6
 Message 4-33, 11-16, 11-20, 11-28, 11-33, 17-1
 METARs 12-20, 12-66, 12-84
 MGRS 16-37
 Mic selection 2-11
 Minimum runway length 1-12
 Miscellaneous symbols 18-9
 Missed Approach 6-14
 MOA 9-40, 18-9
 Model descriptions 1-1
 Monitor 2-12
 Monitoring frequency 3-15
 Morse code 3-17
 Motion vector 10-19, 10-20, 10-26
 Mountains 12-78
 Moving map 1-3
 MPEL 12-38
 MSAS 16-8
 Music 2-23, 14-1, 14-4
 Mute 14-7

N

NACO 7-16
 National Weather Service 12-8, 12-70
 Nav angle 16-33, 16-34
 Navigation map 7-17
 Navigation source iii
 Nav Radio 1-17
 Nav range ring 9-21

NDB 8-15, 9-27, 9-40, 13-10
 Nearest airport 1-12, 1-16, 13-2, 16-19
 Nearest airspace 13-12
 Nearest ARTCC 13-15
 Nearest frequency 3-6
 Nearest FSS 13-17
 Nearest intersection 13-4
 Nearest NDB 13-10
 Nearest User Wpt 13-11
 Nearest VOR 13-6
 Nearest waypoint 13-1
 Nearest weather 13-19
 Negative climb rate 11-28, 11-31, 11-68
 NEXRAD 9-8, 12-8
 Limitations 12-11
 NEXRAD Canada 12-12
 Next airspace 9-42
 Non-directional ownship 18-9
 North up 9-16, 12-1
 NOTAM 8-10

O

OBS 9-51, 19-6
 Obstacle data 11-6, 11-19, 11-33
 Obstacles 9-5, 9-23, 9-28, 10-9, 11-1, 11-6, 11-9, 11-10, 11-11, 11-21, 11-22, 18-5
 Obstructions 11-9, 11-21
 OCN 6-3
 On scene mode 10-24
 Operating distance 12-38
 Overview 1-3
 Ownship 18-9

P

Page menus 9-14, 9-27, 9-33, 9-34
 Page user field 16-32
 Pairing 16-43, 16-44
 Panning 9-41
 Parallel track 4-38, 18-9
 Parking area 18-2
 Passenger address 2-12
 Phone call 14-12
 Phone volume 14-16
 Photocell 16-41

Foreword
 Getting Started
 Audio & Xpdr Ctr
 Com/Nav
 FPL
 Direct-To
 Proc
 Charts
 Wpt Info
 Map
 Traffic
 Terrain
 Weather
 Nearest
 Services
 Music
 Utilities
 System
 Messages
 Symbols
 Appendix

Foreword	Pilot controls 1-4	Reflectivity 12-8, 12-10, 12-11, 12-36, 12-44
Getting Started	PIREP 12-28, 12-68, 12-92	Register with GFDS 12-61
Audio & Xpdr Ctrl	Point obstacle 9-23	Registration vii
Com/Nav	Point-to-Point 15-15, 15-24	Remote frequency control 1-18, 3-14
FPL	Position format 16-37	Remove FPL waypoint 4-12
Direct-To	Position reporting 14-19	Resolution advisory 10-39, 10-43
Proc	Position reporting status 14-20	Reverse frequency look-up 3-14, 16-21, 16-22
Charts	Power line 9-25	Revisions vii
Wpt Info	Power-up 7-15, 7-16, 7-19, 10-10, 11-1, 11-11, 11-20, 11-22, 11-33, 11-72	RLC 11-17, 11-29, 11-62
Map	Precipitation 12-11, 12-33, 12-35, 12-36, 12-46, 12-48, 12-52, 12-53, 12-64, 12-66	RNAV 6-19
Traffic	Precipitation intensity levels 12-41, 12-51	ROC 11-57, 11-58
Terrain	Premature descent alerting 11-18, 11-30, 11-63	Roll steering 6-14, 6-26
Weather	Preset 14-8	Rotorcraft traffic page orientation 10-24
Nearest	Preventive Resolution Advisory 10-43, 10-44	Route options 4-43
Services/Music	Preview flight plan 4-45, 4-51	Runway 16-19
Utilities	Procedures 1-20, 6-1	Runway extension 9-27
System	Procedure turn 6-14	Runway length 1-12, 16-19
Messages	Product age 12-7, 12-63	Runways 8-7
Symbols	Product description 1-3	Runway surface 1-12, 16-19
Appendix	Product Support vii	Ryan TCAD 10-25
	Proximity advisory 10-5	
	R	S
	Radar 9-12, 10-7, 10-9, 12-8, 12-11, 12-33, 12-45, 12-64, 12-71	SafeTaxi 7-17, 7-19, 9-17, 9-27, 18-2
	Radar gain 12-51	SafeTaxi symbols 18-2
	RAIM 15-12	Satellite telephone 14-11
	Rain 12-64	SBAS 16-8
	Range ring 9-21, 10-5, 10-15, 10-17, 10-21, 10-26, 10-30, 10-34, 11-13, 11-24, 12-53	Scale 9-22, 10-13, 18-3
	Recent frequency 3-6	Scheduled messages 15-35
	Record of Revisions vii	Search and Rescue (SAR) 4-5, 4-21
	Reduced protection 11-39	Sector scan 12-33, 12-55
	Reduced required obstacle clearance 11-17, 11-29, 11-62	Secure Digital (SD) card 1-4
	Reduced required terrain clearance 11-17, 11-29, 11-62	Select approach 6-10
		Select arrival 6-7
		Select departure 6-4
		Selected Altitude 12-69
		Selected Altitude Range Arc 9-26
		Self-test 1-7
		Sensor data 15-15, 15-23
		Serial numbers 14-9, 16-4
		Service Class 14-3
		Services 12-71, 14-1
		Setup 16-15

Shield setup	10-32	
SIDs	1-20	
SIGMET	12-17, 12-70, 12-85	
Smart Airspace	9-30	
SMS	14-16	
Snow	12-11, 12-36	
Software version	14-9, 16-3	
Sort alpha	4-16	
Special Use Airspace	13-1	
Speed	11-18, 11-30, 11-63	
Squawk code	2-4	
Squelch	1-4, 2-21, 3-2	
Standby	2-2	
Standby database	16-4	
STAR	6-7, 7-16	
STARs	1-20	
Start-up	1-6	
Status	14-20, 16-4, 16-11	
Store flight plan	4-29	
Storm cell	12-48	
Stormscope	9-11, 12-29, 18-10	
Stuck microphone	3-14	
Sunrise/Sunset	15-13	
Support	vii	
Suppress Visuals	14-15	
Surface winds	12-70	
Symbols	9-52, 10-4, 10-13, 11-16, 11-27, 11-52, 18-1, 18-3	
System ID	16-4	
System power	1-6	
System setup values	1-11, 1-12	
System status	10-10, 10-16, 11-20, 11-33, 11-72, 16-3	
T		
TAF	12-66	
Target altitude	15-6	
Target offset	15-8	
Target waypoint	15-8, 15-9	
TAS	10-3, 10-12, 10-13, 15-29	
TAWS-A	11-51	
TAWS-A alerts	11-52, 11-56	
TAWS-B	11-10, 11-21, 11-51	
TAWS-B alerts	11-16, 11-27	
TAWS failure alert	11-19, 11-33	
TAWS system test	11-11, 11-20, 11-22, 11-33, 11-72	
TCAD	10-25	
TCAD 9900B	10-30	
TCAD 9900BX	10-25, 10-34	
TCAS	10-4	
TCAS II	10-38, 10-40, 10-46	
TCAS II alerts	10-41	
TCAS II system test	10-45	
Telephone	2-24	
Telligence	2-26	
Telligence Voice Command Qualification Procedure	19-25	
Temperature	16-33	
Temporary	8-20	
TERM	6-3	
Terrain	9-5, 9-28, 10-9, 11-1, 11-10, 11-21, 11-57, 11-58, 11-59, 12-37, 18-5	
Terrain alerts	11-31, 11-68	
Terrain Awareness and Warning System	11-51	
Terrain data	9-7, 11-9, 11-10, 11-21	
Terrain limitations	11-9	
Terrain obstacle symbols	11-12, 11-23, 11-53, 18-5	
Terrain proximity	ii, 11-6, 18-8	
Text	12-71	
Text messaging	14-17	
TFR	9-27, 12-81, 18-9	
Thunderstorms	12-36, 12-40, 12-41, 12-43	
Time	16-6, 16-8, 16-18	
Time format	1-12	
Time until transmit	14-20	
TIS	10-3, 10-4, 10-7, 10-9	
Topo data	9-5	
Topo scale	9-22	
Tornadoes	12-43	
Touchscreen	1-2, 1-6	
Track vector	10-8	
Traffic	9-12, 10-1	
Traffic advisory	9-33, 10-3, 10-4, 10-39	

- Foreword Traffic audio 10-28, 10-31
 Traffic Pop-Up 10-1
- Getting Started Traffic symbols 10-4, 10-13, 10-18, 18-2
 Traffic test 10-2
- Audio & Xpdr Ctrl Transponder 2-1, 10-3, 10-7, 10-9, 10-10, 10-13
 Trip planning 15-13
- Com/Nav Trip planning - point-to-point 15-13, 15-14, 15-15, 15-18
- FPL Troubleshooting 17-1
 Turbulence 12-27, 12-33, 12-36, 12-41, 12-70
- Direct-To Turbulence Detection 12-54
- Proc **U**
 Under construction 18-2
- Charts Units 1-13, 16-33
 User-defined hold 4-19, 5-9
- Wpt Info User fields 9-35, 16-30
 User frequency 3-11
- Map User waypoint 8-16, 8-19, 9-44, 13-11
 UTC 1-12, 16-18
- Traffic Utilities 15-1
 UTM 16-37
- Terrain **V**
 V CALC 15-4, 15-5
- Weather Vector Duration 10-23
 Vector motion 10-20
 Vector-To-Final 6-17
- Nearest Version 1-6, 11-1, 11-11, 11-22
 Vertical Calculator 15-4
- Services/Music Vertical scan 12-33, 12-41, 12-42, 12-48
 Vertical speed 15-7
- Utilities VFOM 16-5, 16-7
 VFR 2-3, 12-20, 12-67, 12-84
- System View catalog 4-43
 VNAV 4-30, 9-20, 19-8
 Voice alert 10-9
- Messages Voice call out 11-17, 11-19, 11-28, 11-33, 11-45, 11-46, 11-57, 11-59, 11-71, 16-39
 Voice command 2-26, 16-46
- Appendix Voice recognition 2-26
 Volume 1-4, 3-2, 14-2, 14-7
- VOR 3-16, 8-13, 9-27, 9-40, 11-13, 11-24, 13-6
 VOR-based approach 6-27
 VRP 8-14
- W**
 WAAS 16-8
 Warnings ii
 Warranty i
 WATCH 12-35, 12-52
 Waypoint information 4-14, 8-1
 Waypoint options 4-5
 Weather 8-9, 9-34, 12-1, 12-56
 Weather alert 12-53
 Weather legend 12-5
 Weather mapping 12-41
 Weather product 12-63, 14-3
 Weather radar 9-12, 12-45
 Wind 9-1, 12-66, 12-69, 12-70
 Winds 15-29
 Winds aloft 12-25, 12-69, 12-89
 Winds aloft altitude 12-69
 Wire obstacle 9-25
 WX-500 9-11, 12-29
- X**
 XM 14-2
 XM channel categories 14-5
 XM radio activation 14-3
 XM radio channel presets 14-8
 XM radio channels 14-6
 XM radio volume 14-7
 XM Satellite Radio 14-2
 XM troubleshooting 14-9
 XM weather 12-2
- Z**
 Zulu 16-18



190-01007-03 Rev. R